

# Spatial, Temporal, and Interpretive Limits of Functional MRI

Peter A. Bandettini, Ph.D

Unit on Functional Imaging Methods  
&  
3T Neuroimaging Core Facility

Laboratory of Brain and Cognition  
National Institute of Mental Health

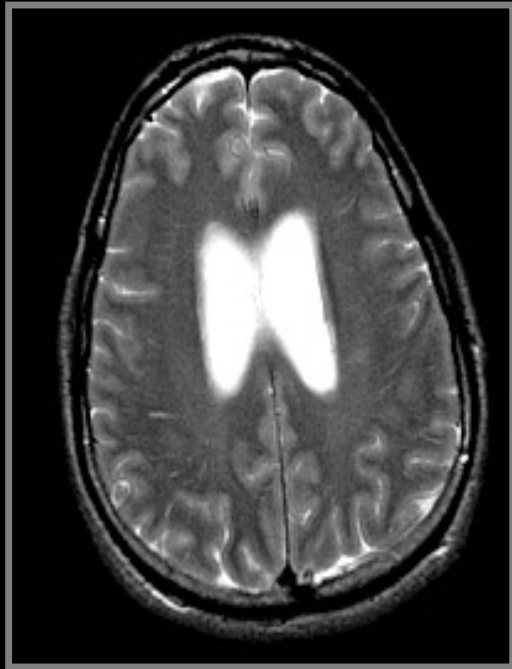

Anatomic

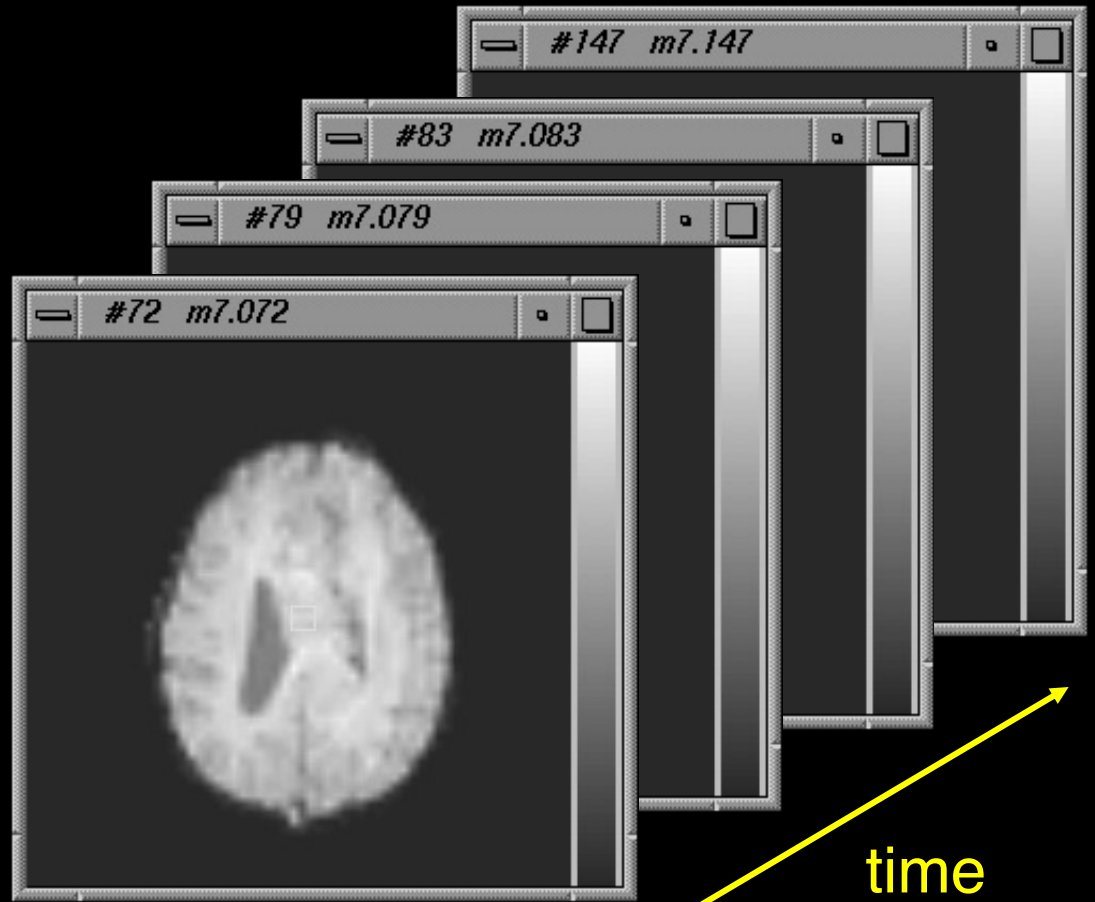

Functional

# Echo-Planar Imaging

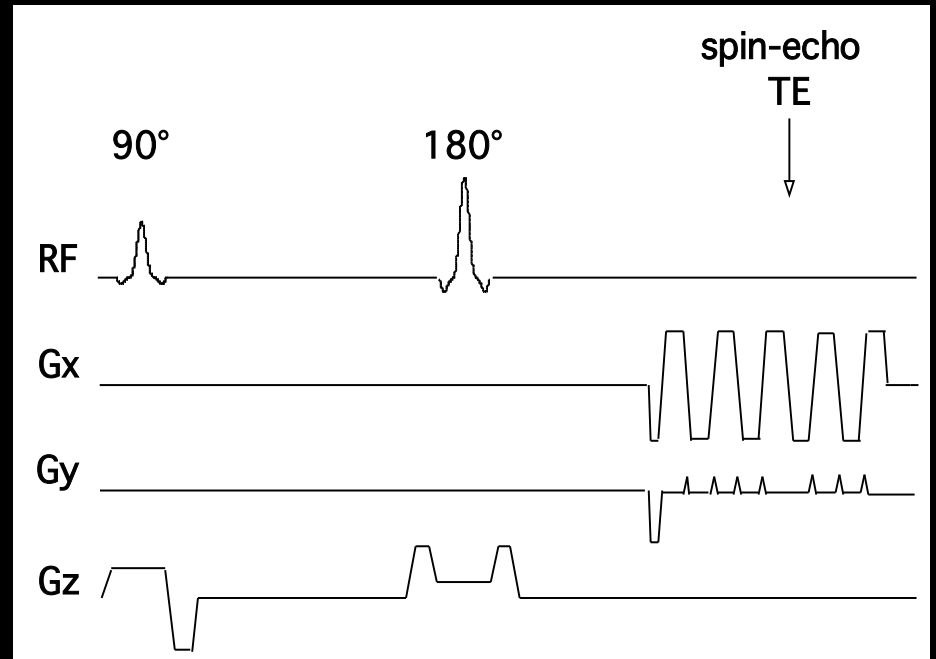
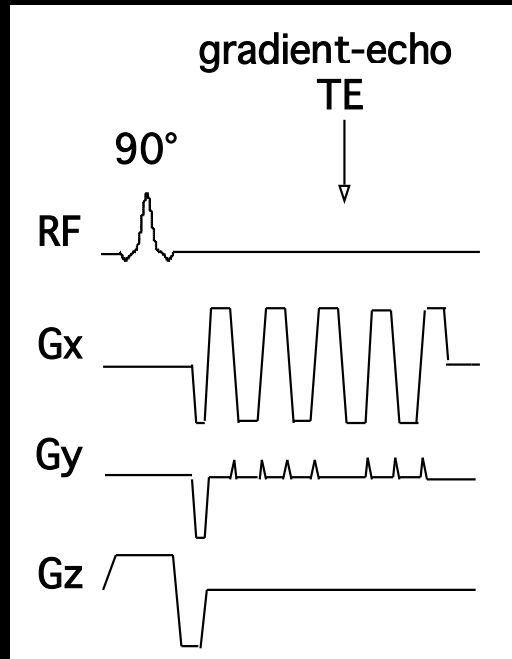

# Single Shot Imaging

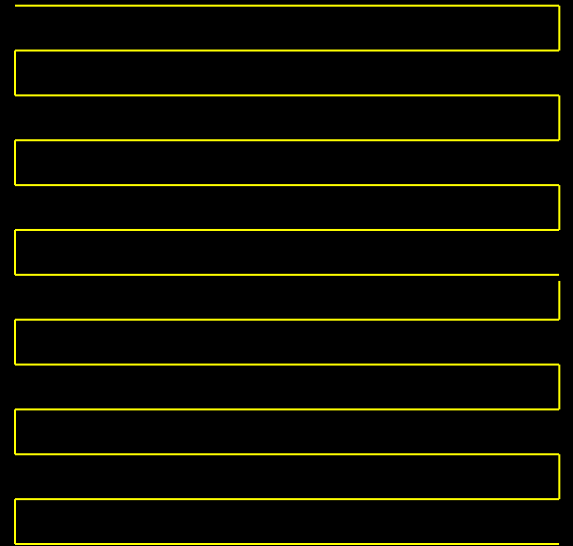
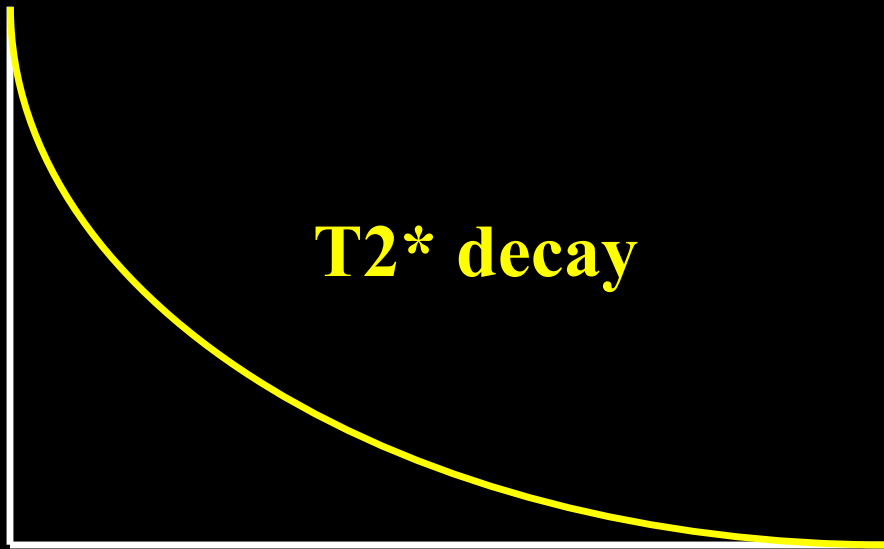

**EPI Readout Window**

**$\approx 20$  to  $40$  ms**

# Imaging System Components

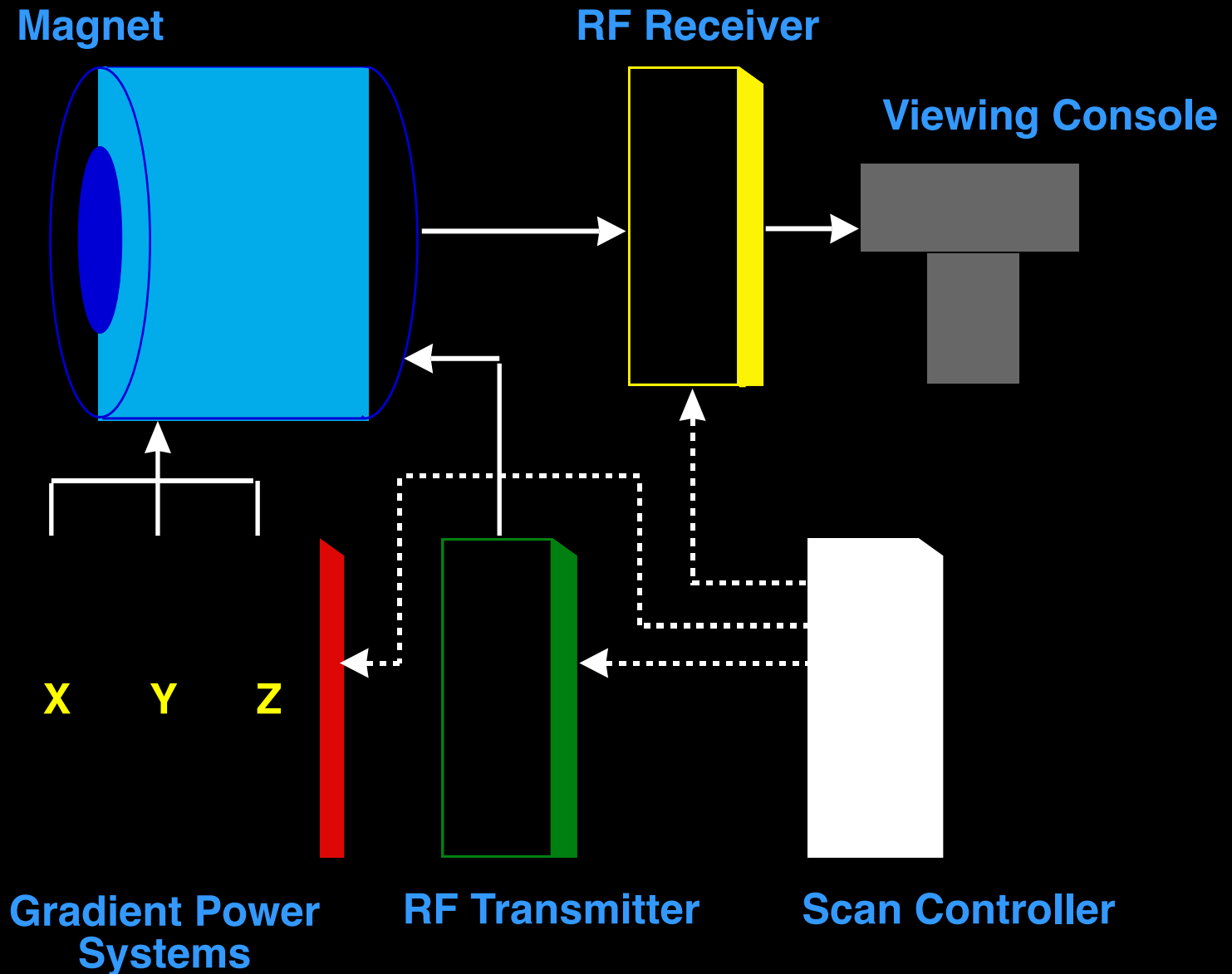

# Local gradients solved the problem

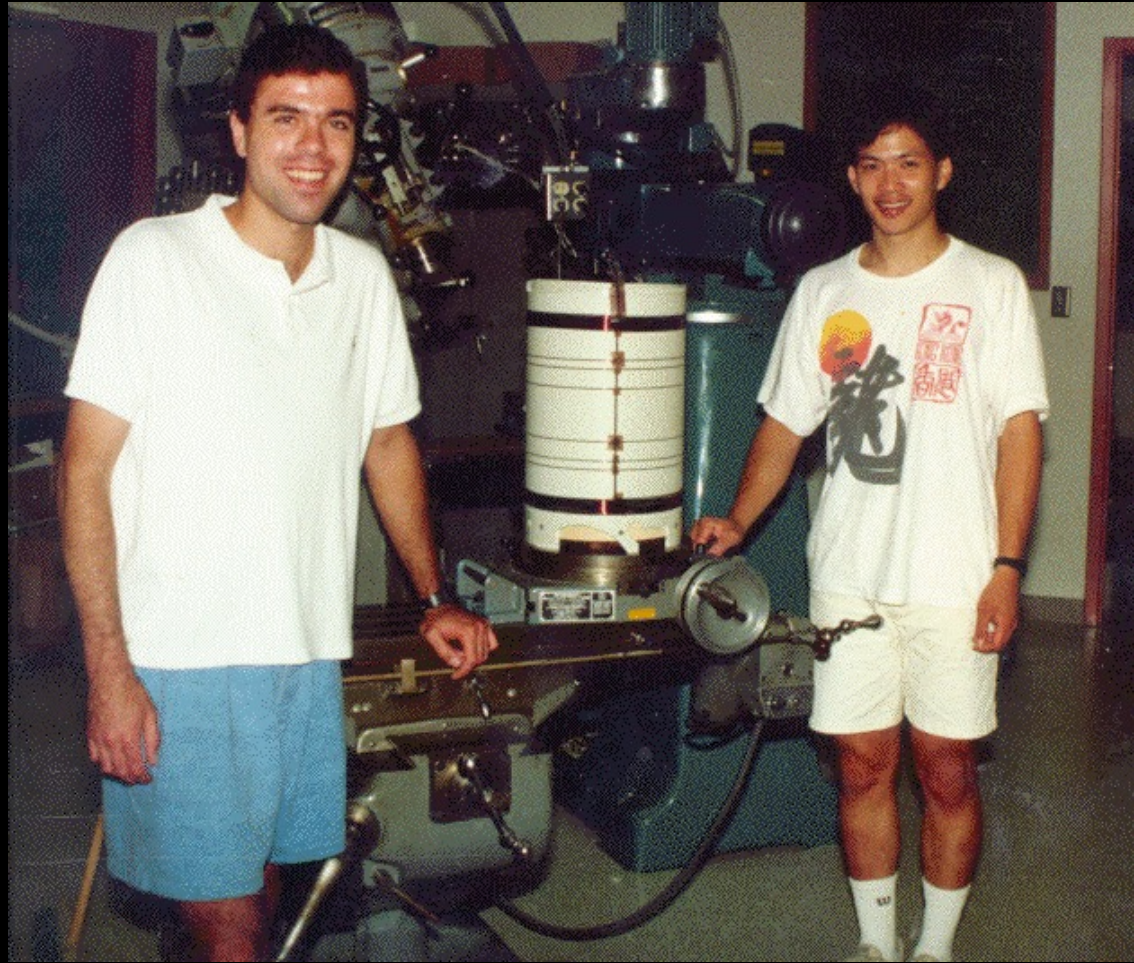

**1991-1992**



**1992-1999**



2 G/cm, 350 T/m/s

4 G/cm, 150 T/m/s

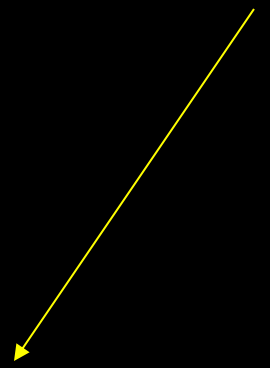
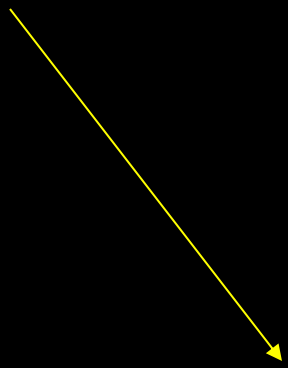
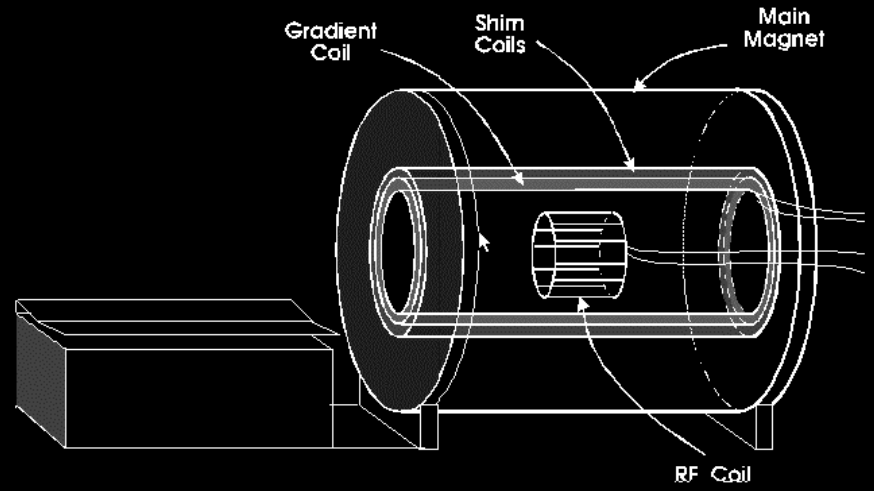

10 G/cm, 1000 T/m/s



# The use of fMRI to Investigate Brain Function

**Where?**

**When?**

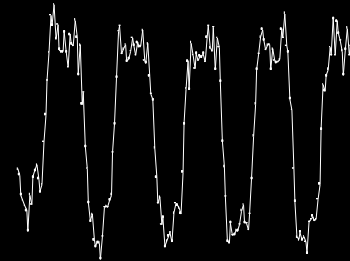
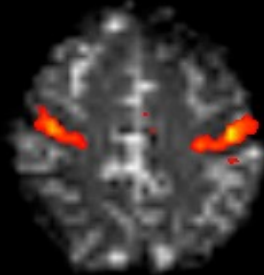

**How much?**

---

**How to get the brain to do what we want it to do in the context of an fMRI experiment?**

# A Primary Challenge:

...to make progressively more precise inferences using fMRI without making too many assumptions about non-neuronal physiologic factors.

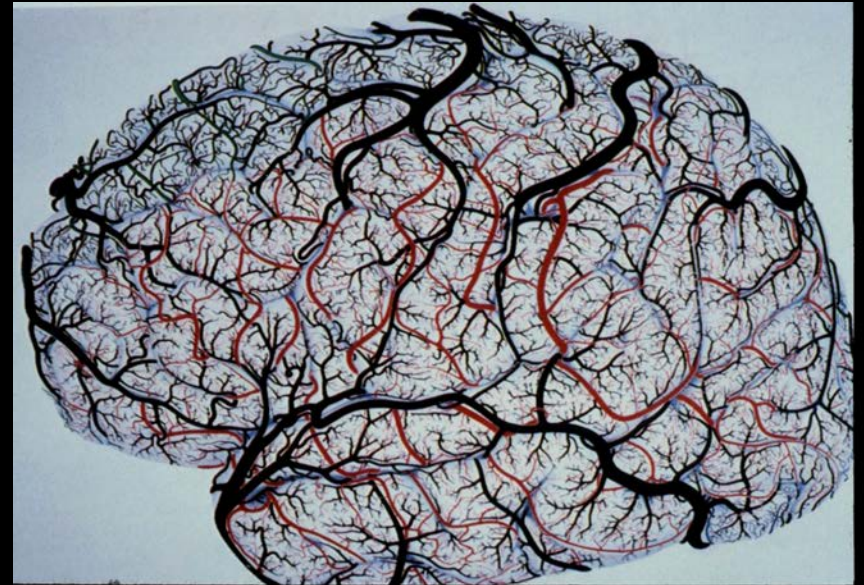
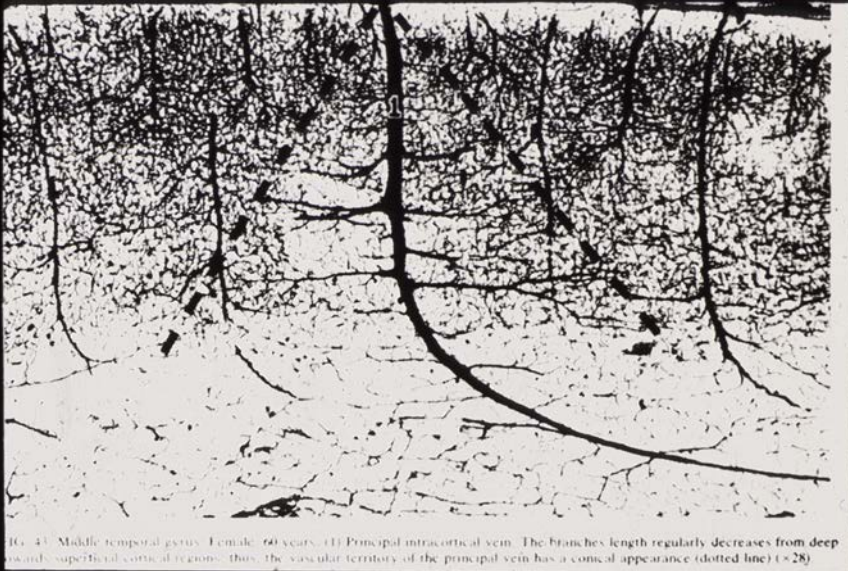

- **Contrast in fMRI**

*Hemodynamic Specificity*

- **The Hemodynamic Transfer Function**

*Location, Latency, Magnitude*

- **Best Results So Far**

*Temporal Resolution, Spatial Resolution*

- **Neuronal Activation Input Strategies**

*Block Design*

*Phase and Frequency Encoding*

*Orthogonal Designs*

*Parametric Designs*

*Event-Related Designs*

*Free Behavior Designs*

- **Contrast in fMRI**

*Hemodynamic Specificity*

- **The Hemodynamic Transfer Function**

*Location, Latency, Magnitude*

- **Best Results So Far**

*Temporal Resolution, Spatial Resolution*

- **Neuronal Activation Input Strategies**

*Block Design*

*Phase and Frequency Encoding*

*Orthogonal Designs*

*Parametric Designs*

*Event-Related Designs*

*Free Behavior Designs*

# Contrast in Functional MRI

- **Blood Volume**

- Contrast agent injection and time series collection of T2\* or T2 - weighted images

- **BOLD**

- Time series collection of T2\* or T2 - weighted images

- **Perfusion**

- T1 weighting
- Arterial spin labeling

- **CMRO<sub>2</sub>**

- BOLD and Perfusion w/  
Normalization to Global Perfusion Change

# Resting

# Active

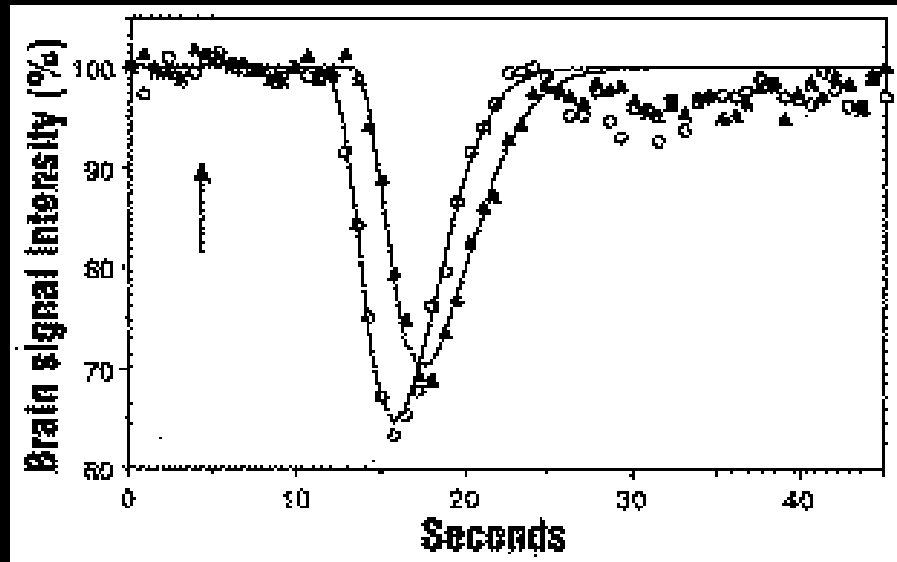
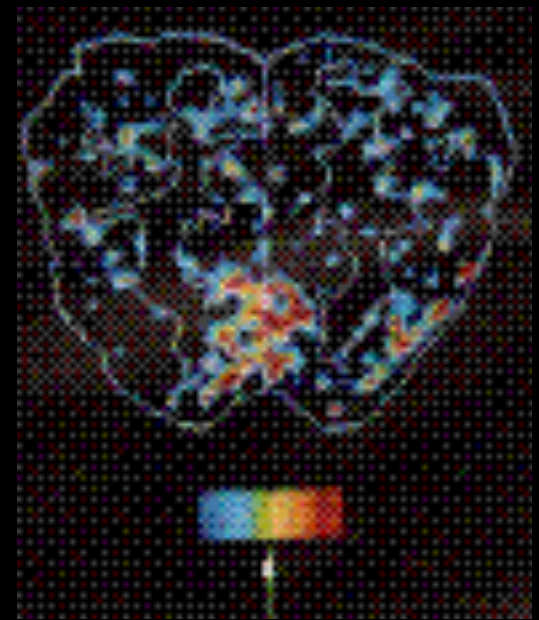
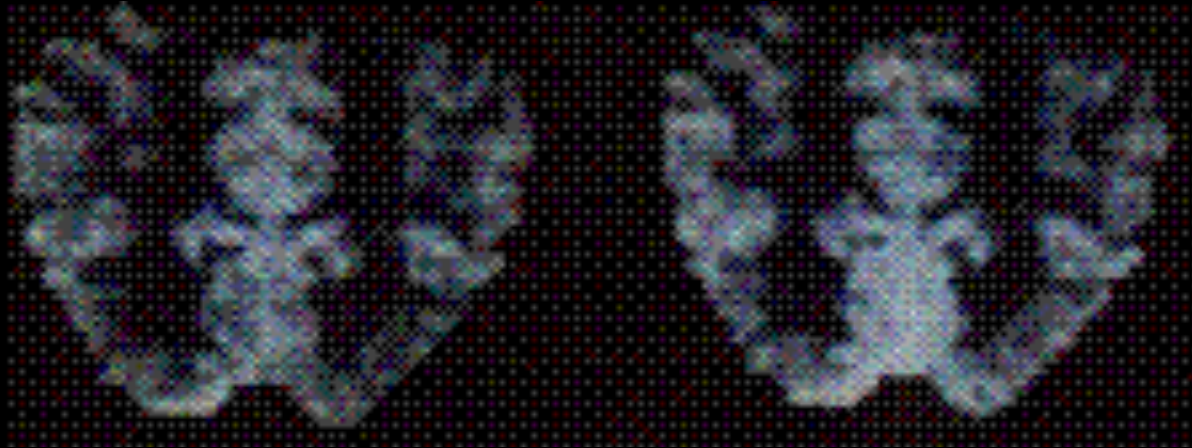

# Photic Stimulation

MRI Image showing  
activation of the  
Visual Cortex

From Belliveau, et al.  
Science Nov 1991

MSC - perfusion

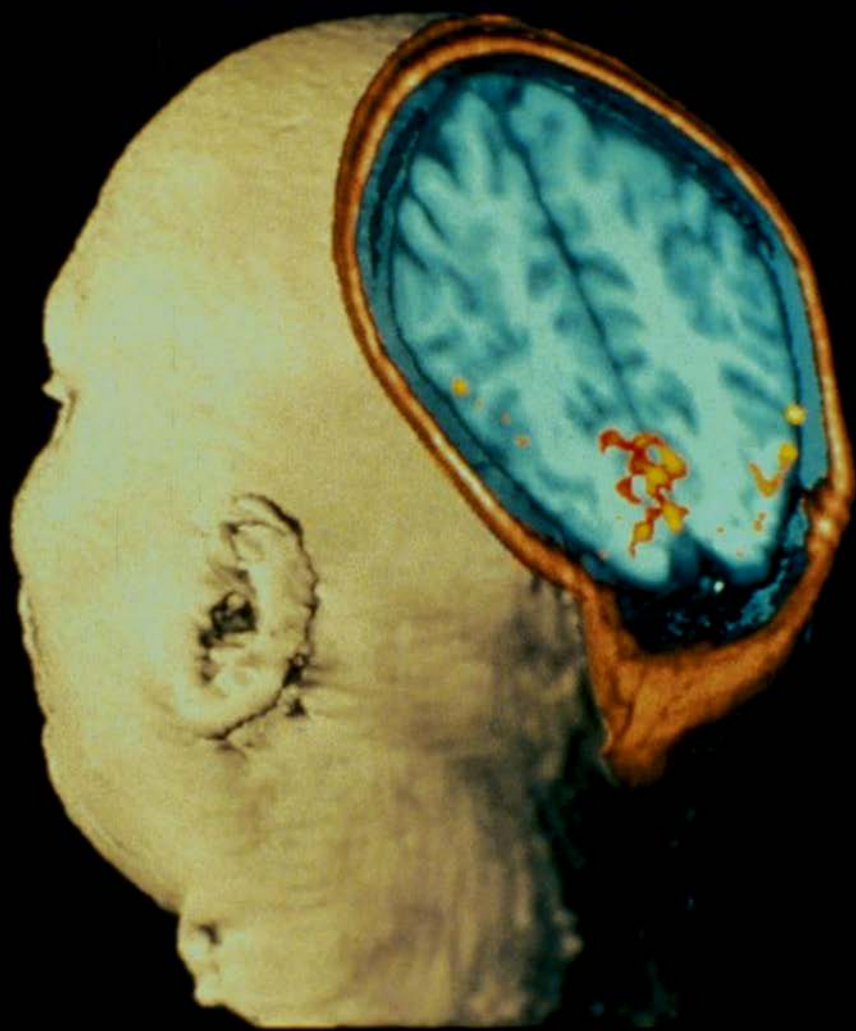

Susceptibility-Induced Field Distortion in the  
Vicinity of a Microvessel  $\perp$  to  $B_0$ .

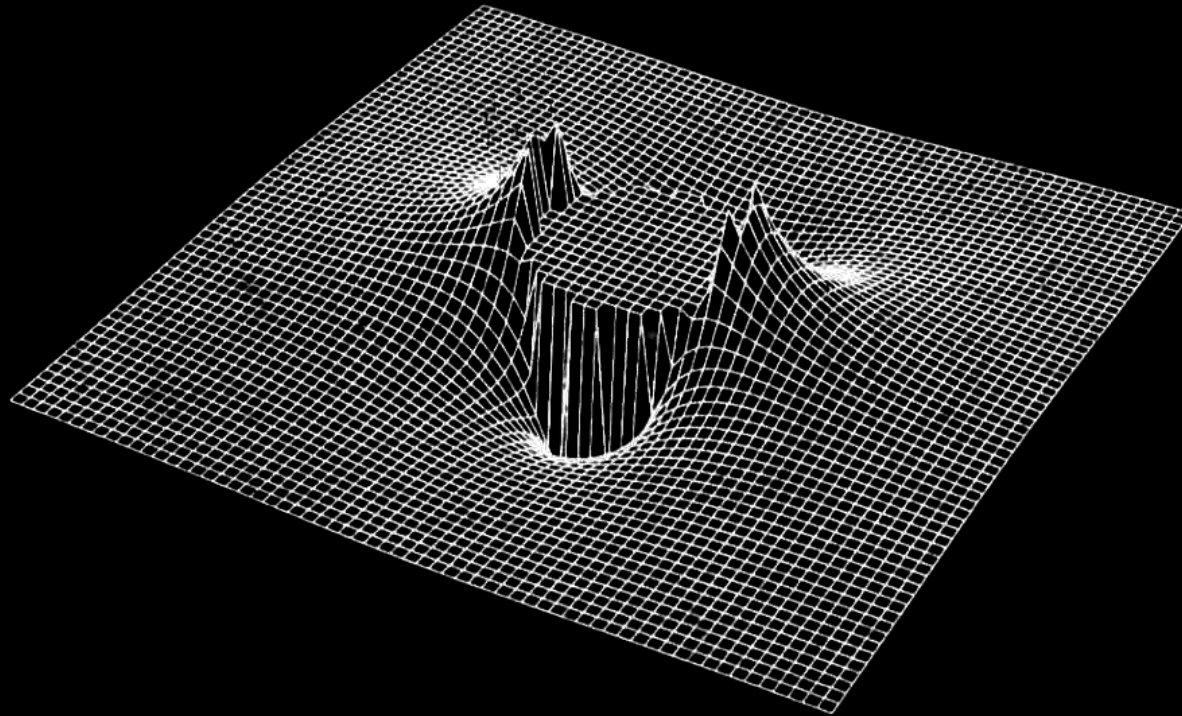



# BOLD Contrast in the Detection of Neuronal Activity

Cerebral Tissue Activation



Local Vasodilation



Increase in Cerebral Blood Flow and Volume



Oxygen Delivery Exceeds Metabolic Need



Increase in Capillary and Venous Blood Oxygenation



Decrease in Deoxy-hemoglobin

*Deoxy-hemoglobin: paramagnetic*  
*Oxy-hemoglobin: diamagnetic*



Decrease in susceptibility-related intravoxel dephasing



Increase in T2 and T2\*



Local Signal Increase in T2 and T2\* - weighted sequences

# The BOLD Signal

Blood Oxygenation Level Dependent (BOLD) signal changes

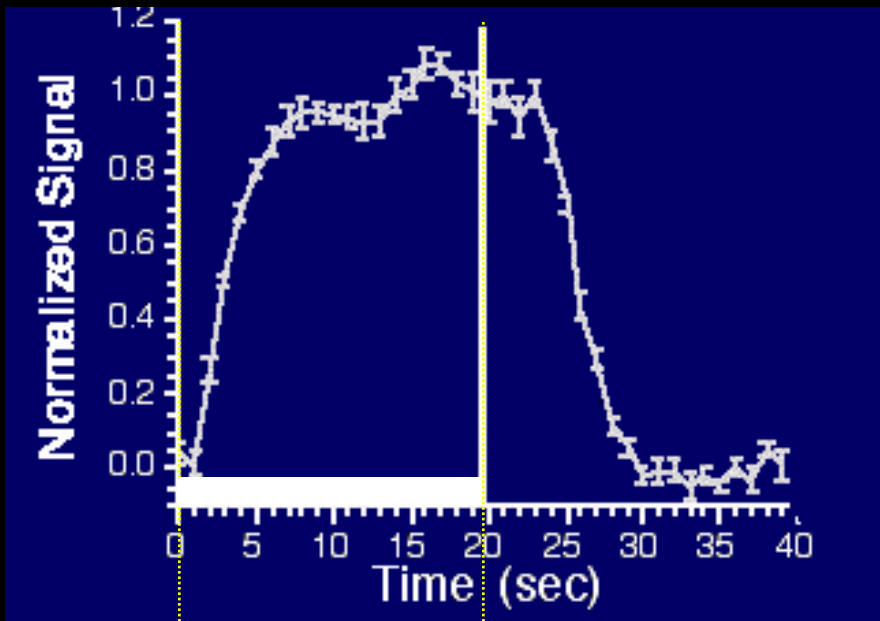

task

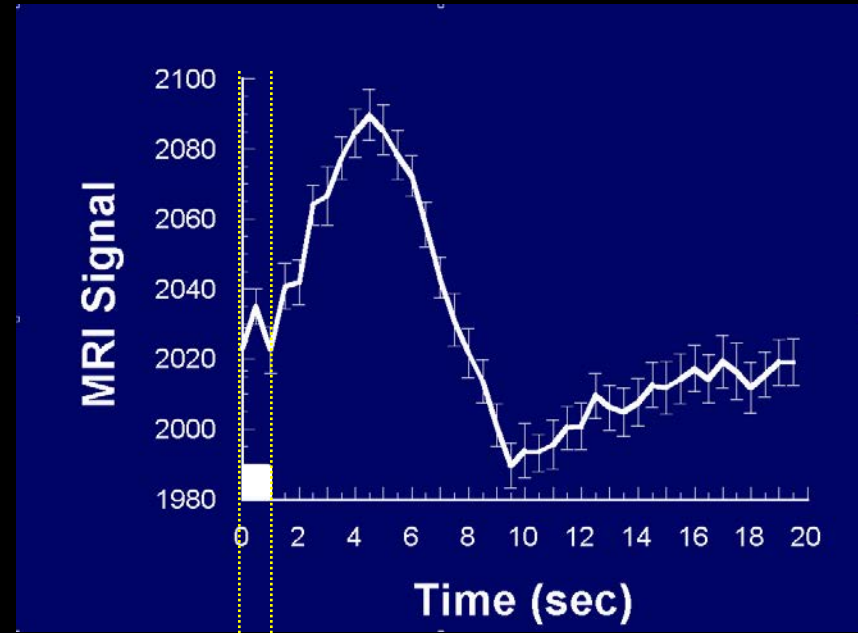

task

# Alternating Left and Right Finger Tapping



~ 1992

# Creating a Functional Image

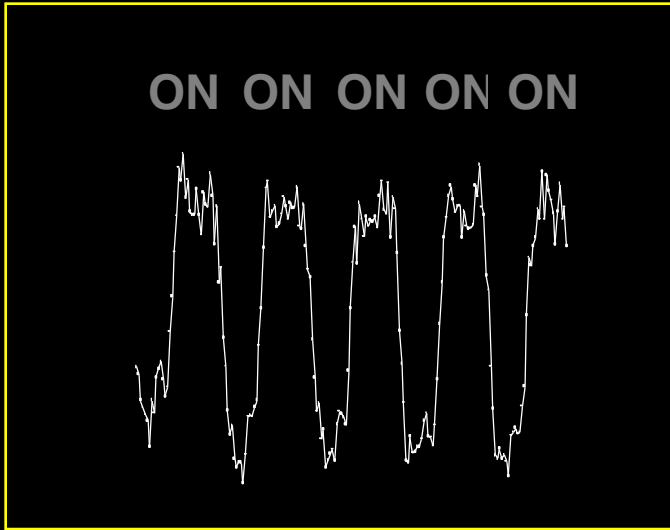

Signal Time Course

X

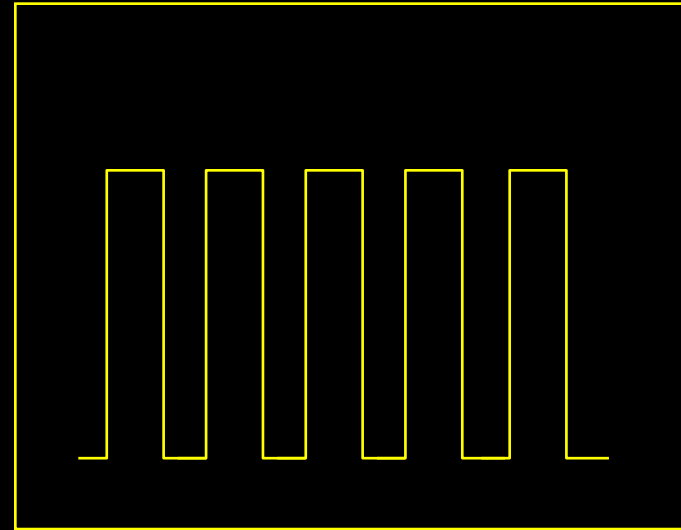

Reference Function

=





Cross Correlation Image

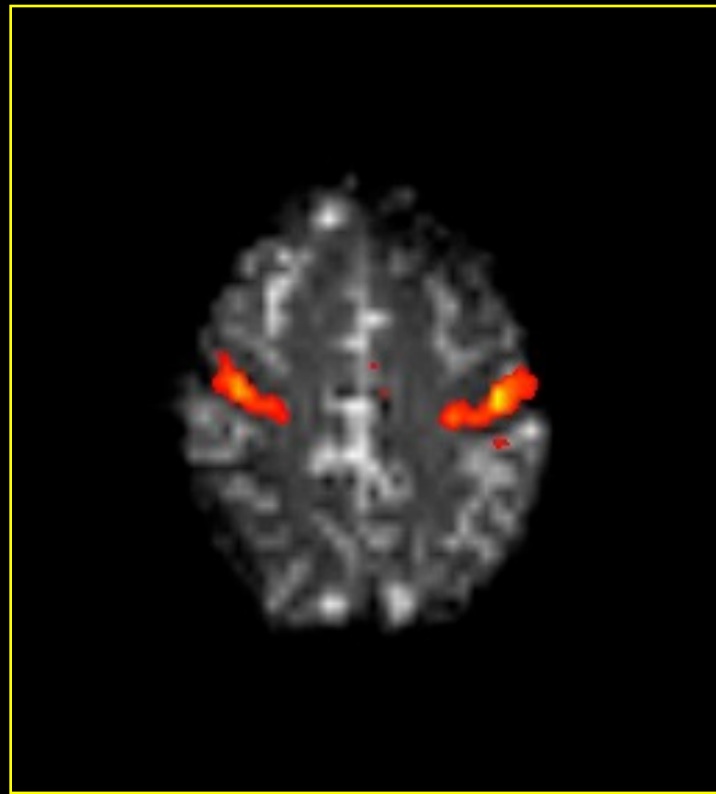

Cross Correlation Image  
Anatomical Image



# Perfusion / Flow Imaging

EPISTAR

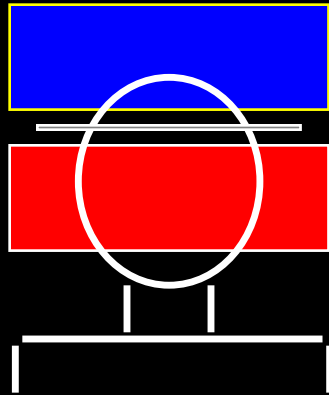

FAIR

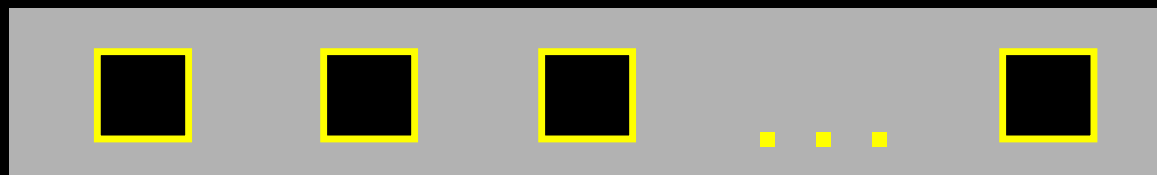
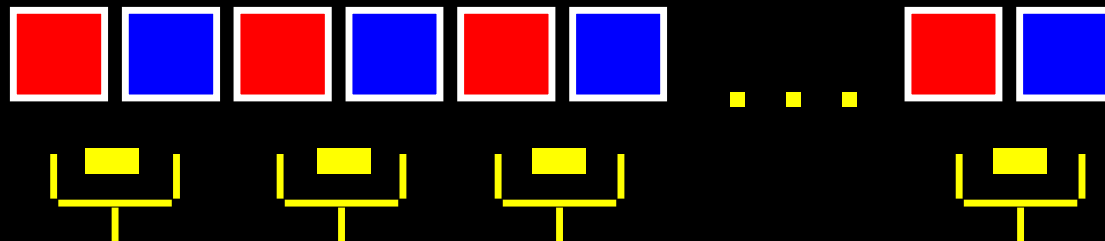
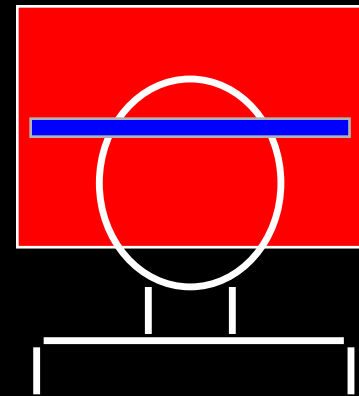

Perfusion  
Time Series

TI (ms)

**FAIR**

**EPISTAR**

200

400

600

800

1000

1200

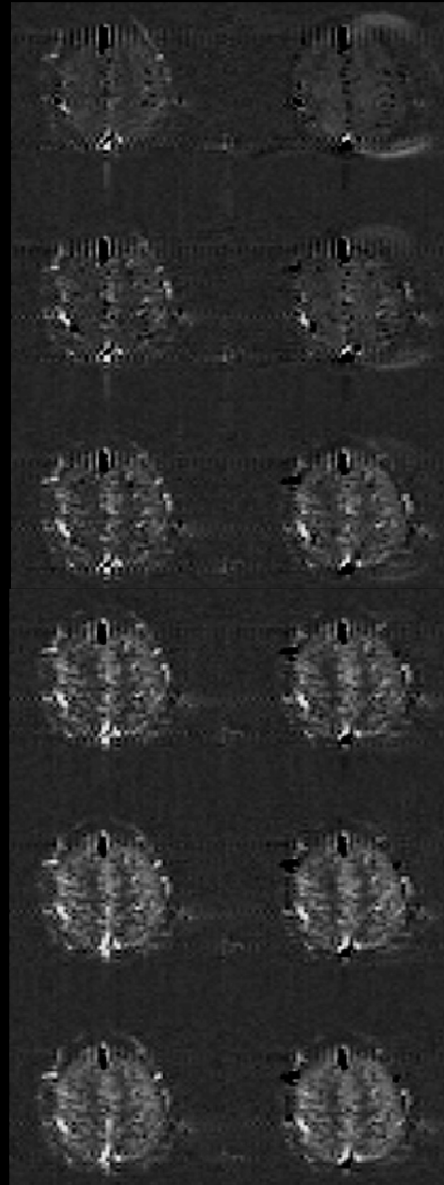



# Resting ASL Signal

---

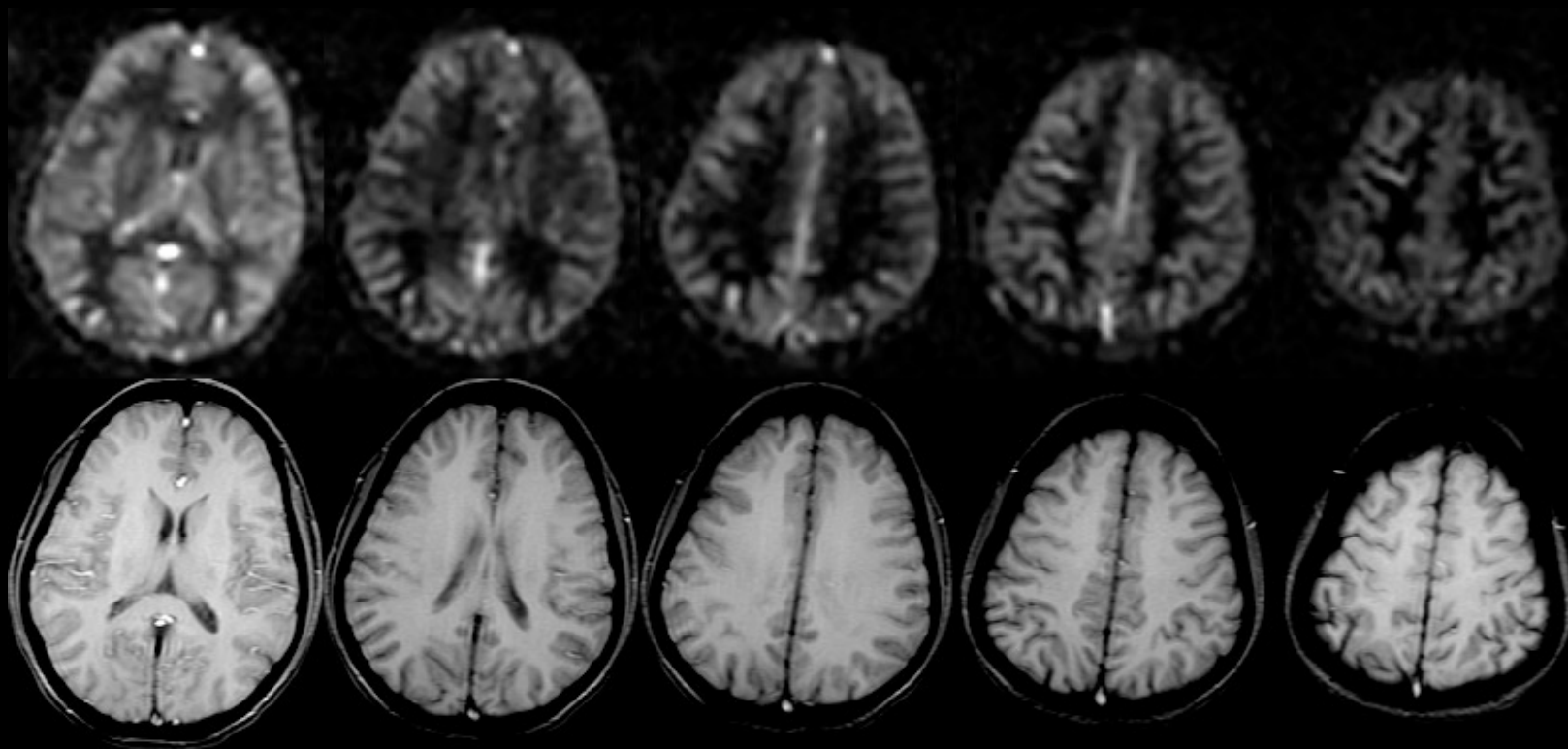

# Comparison with Positron Emission Tomography

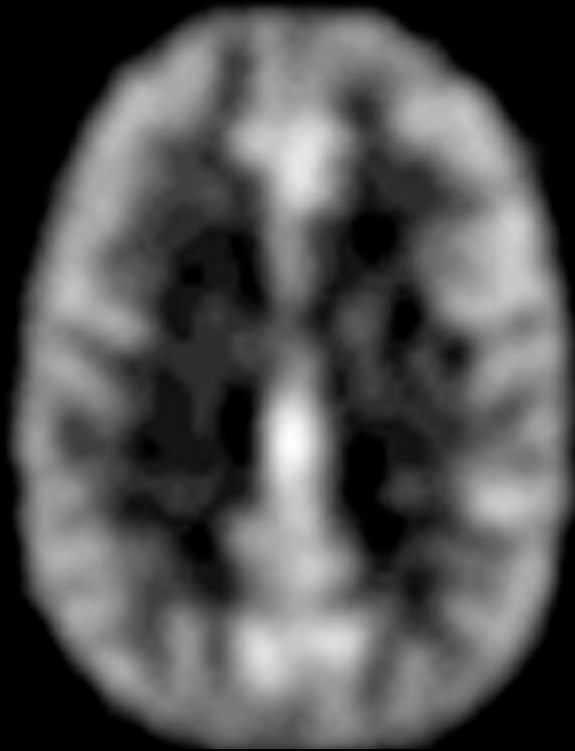

PET:  $\text{H}_2^{15}\text{O}$

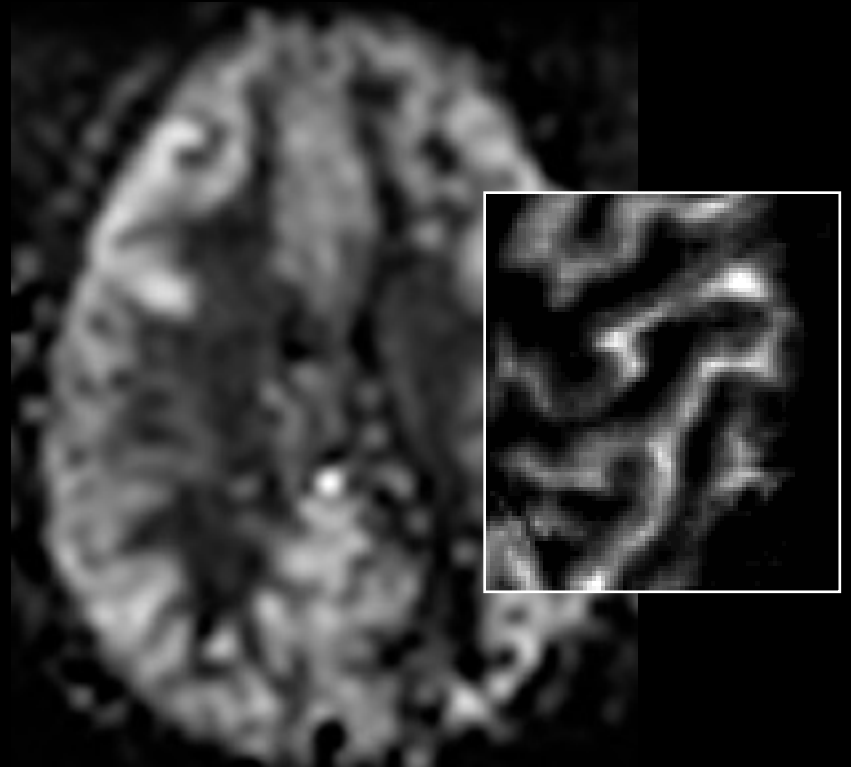

MRI: ASL

# Perfusion

**BOLD**

*Rest*

*Activation*

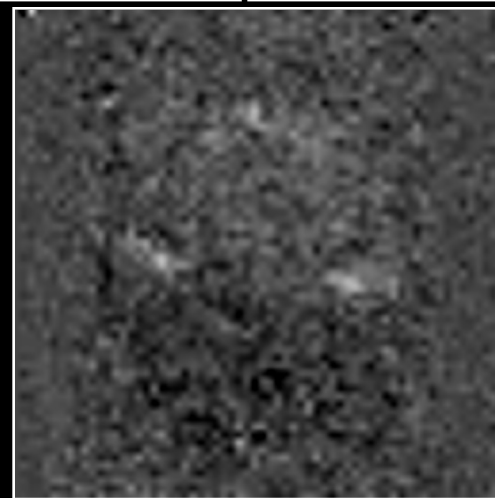
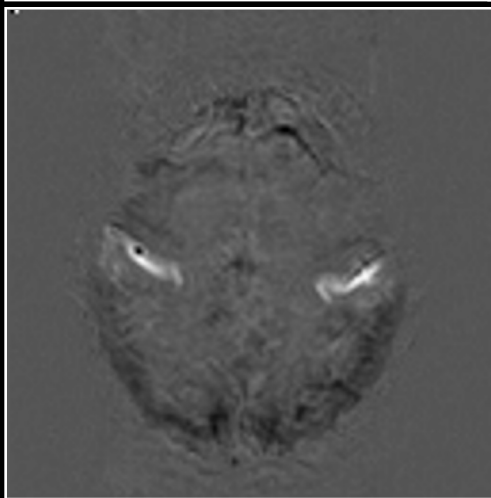
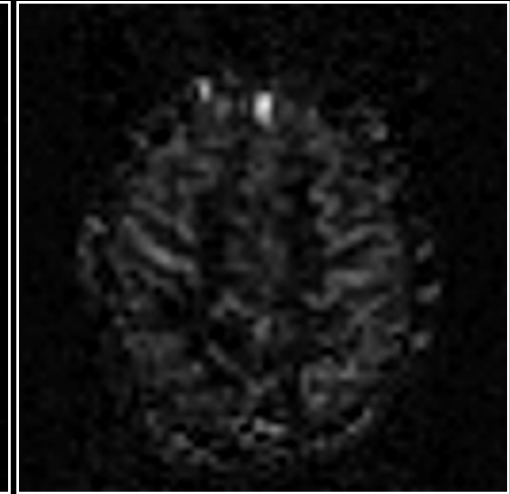
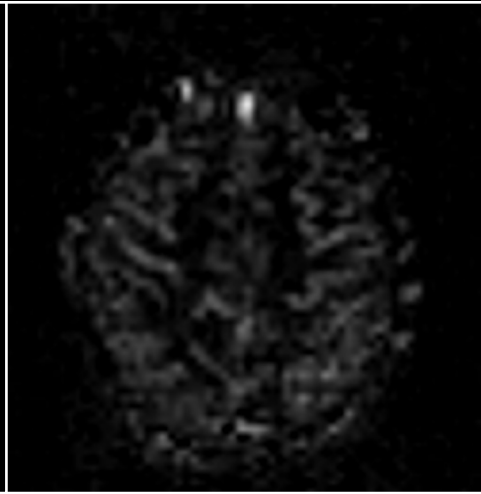
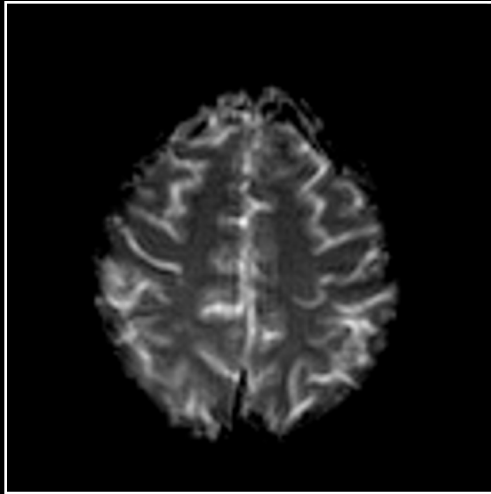

**Anatomy**



**BOLD**



**Perfusion**



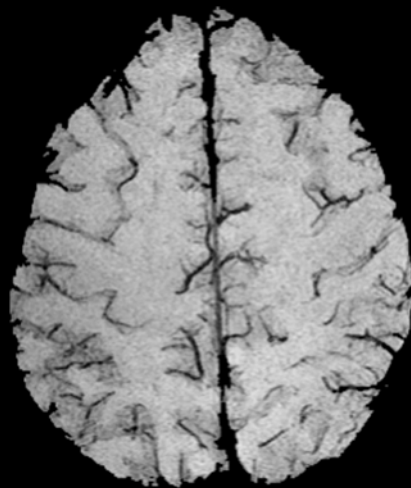
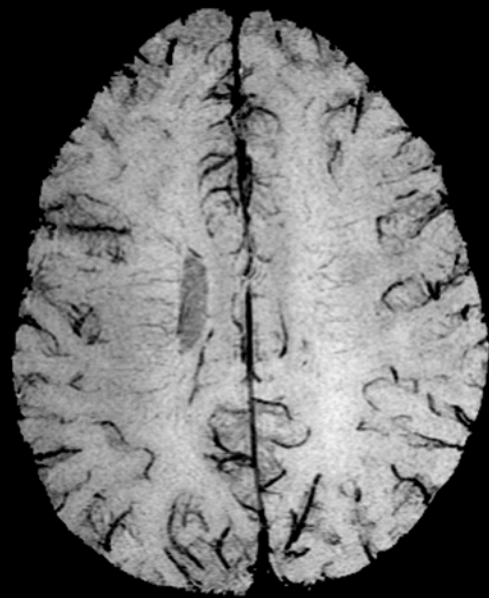

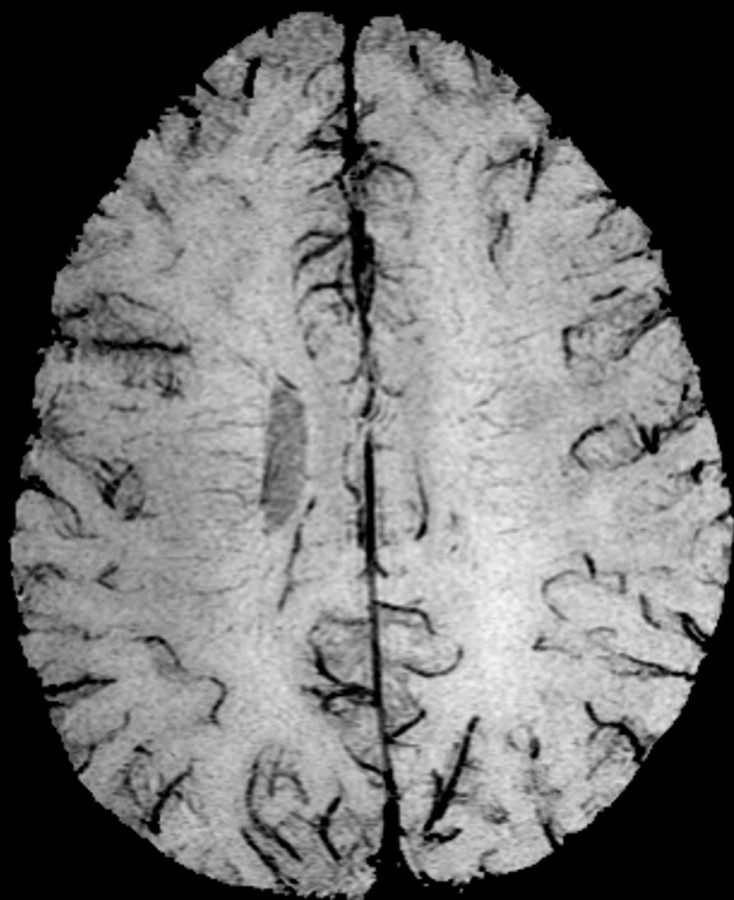
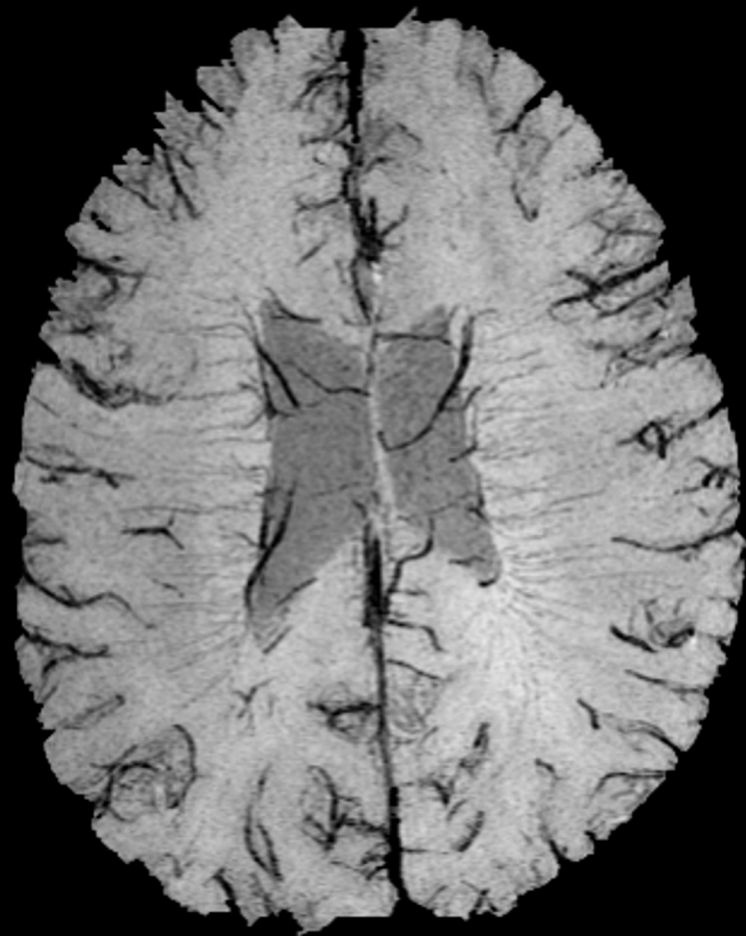

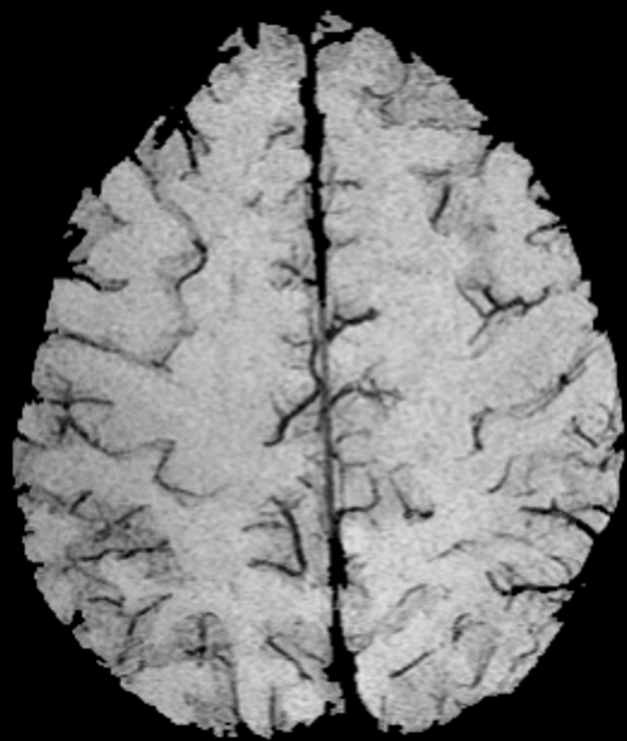





# Hemodynamic Specificity

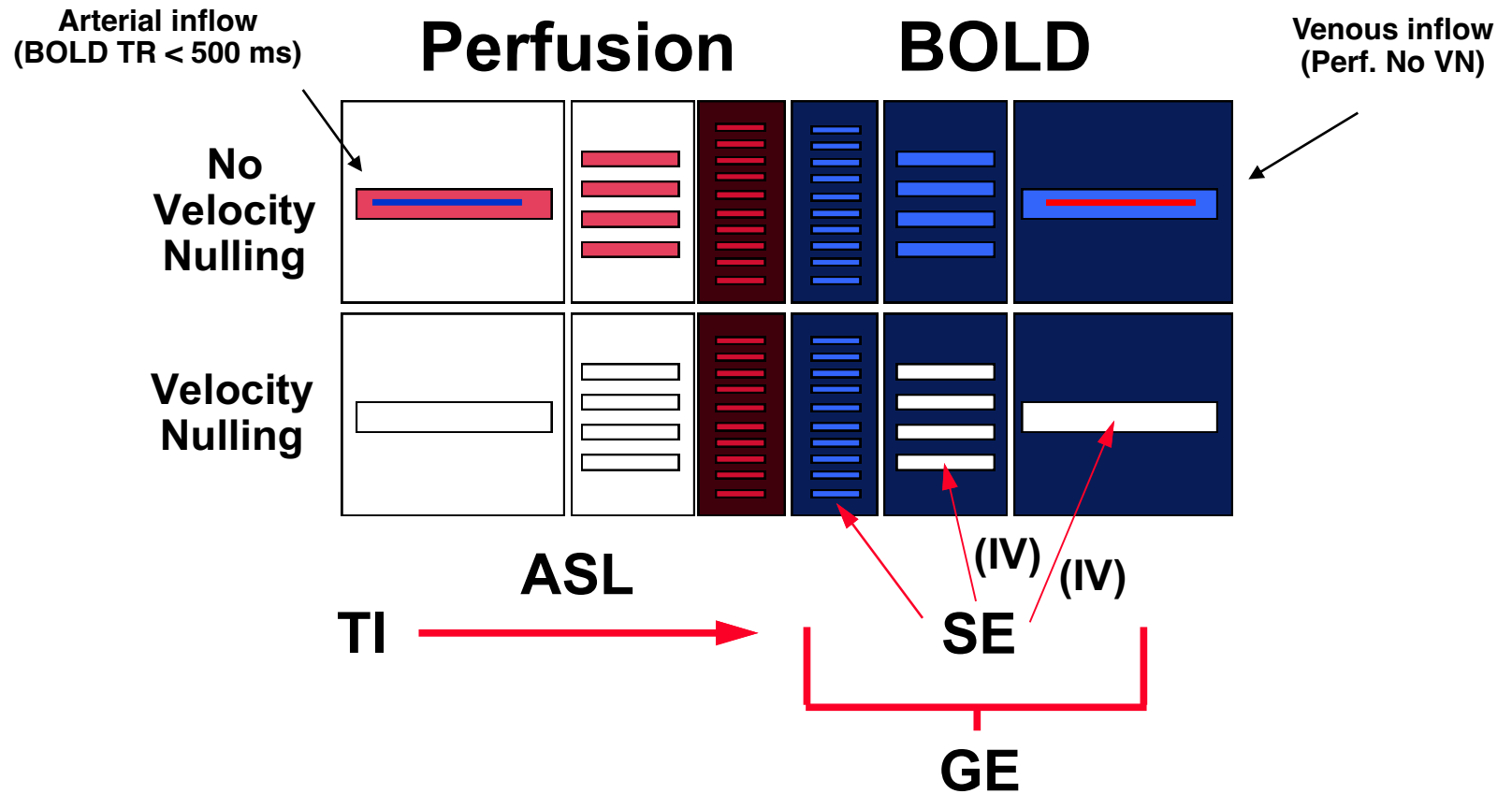

# Hemodynamic Stress Calibration

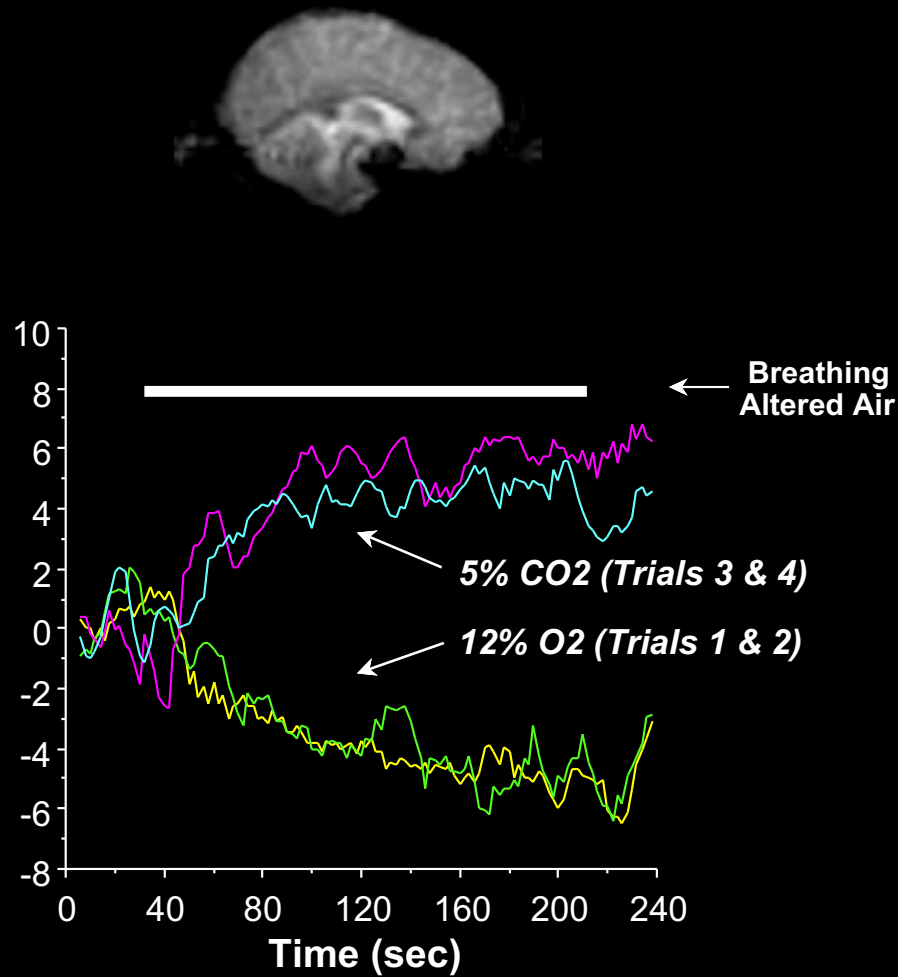

**5% CO2**

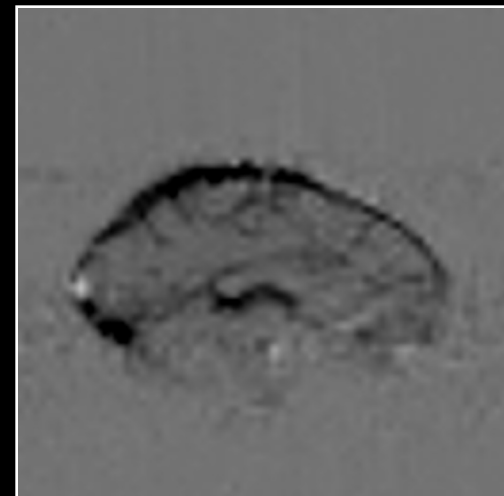
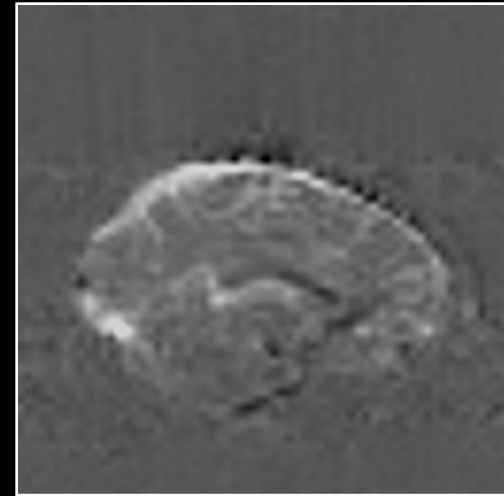

**12% O2**

# CMRO<sub>2</sub>-related BOLD signal deficit:

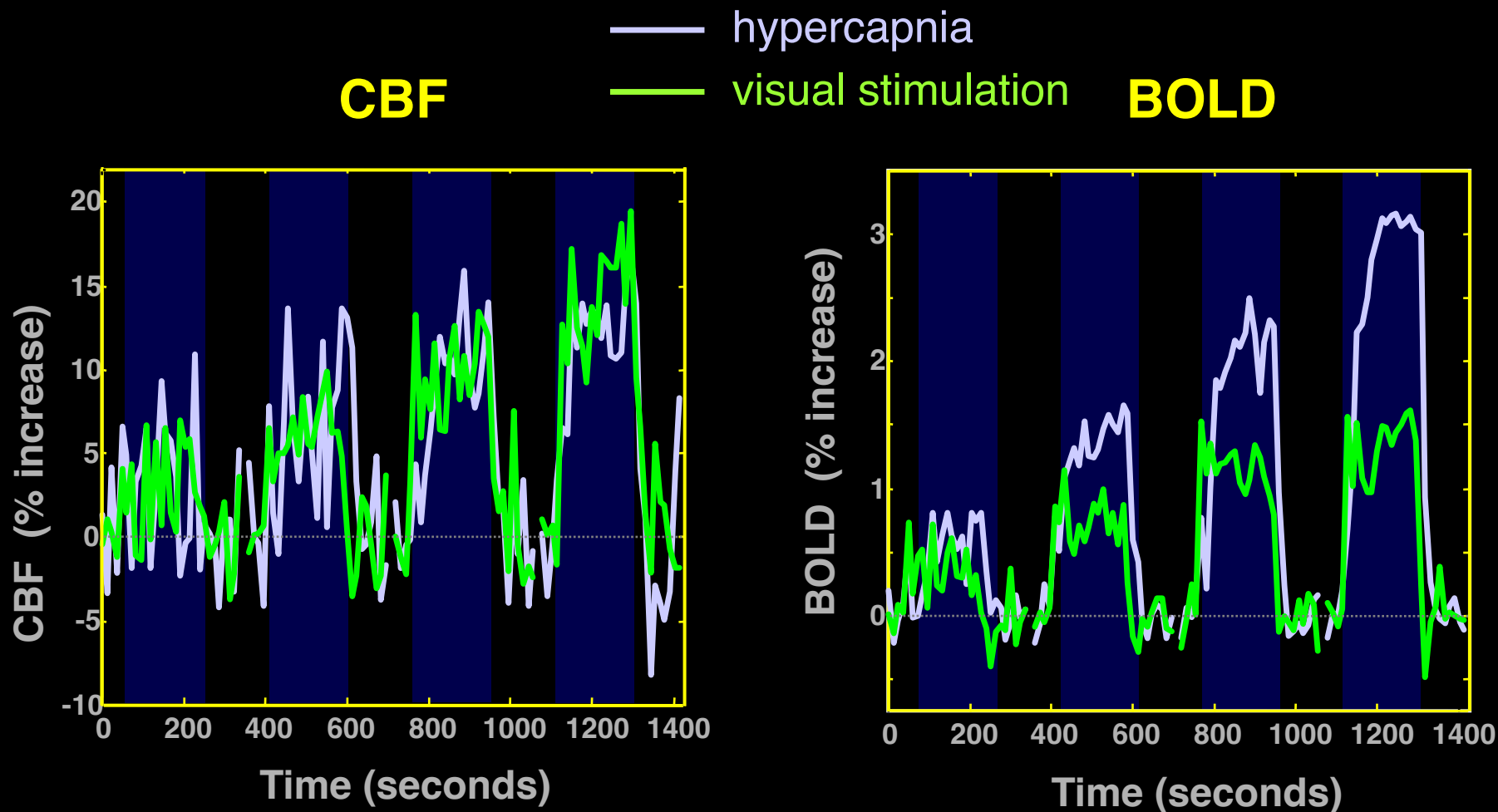

Simultaneous Perfusion and BOLD imaging during graded visual activation and hypercapnia

# CBF-CMRO<sub>2</sub> coupling

*Hoge, et al.*

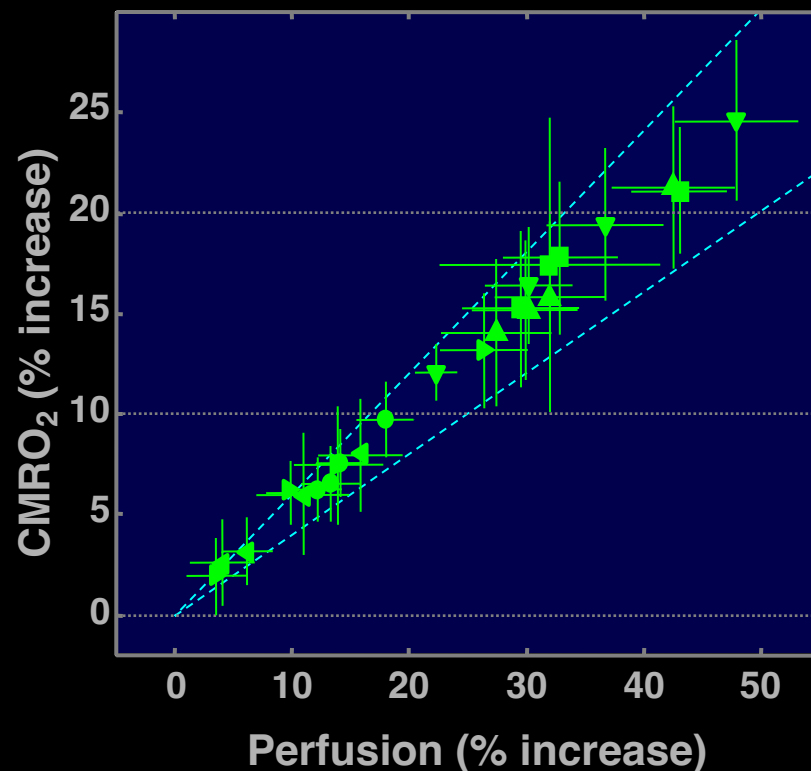
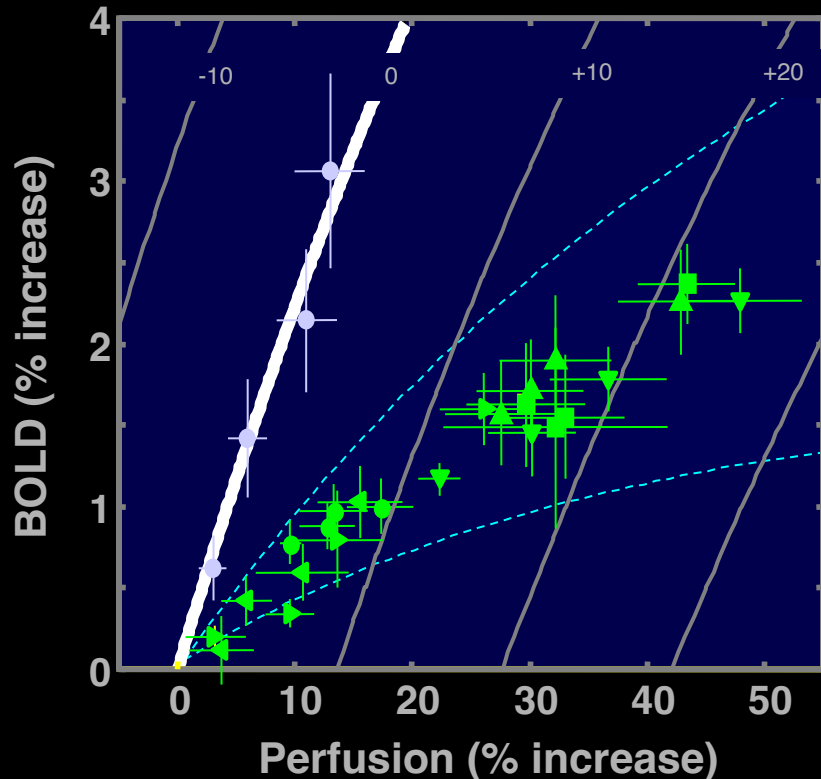

**Characterizing Activation-induced CMRO<sub>2</sub> changes using calibration with hypercapnia**

# Computed CMRO<sub>2</sub> changes

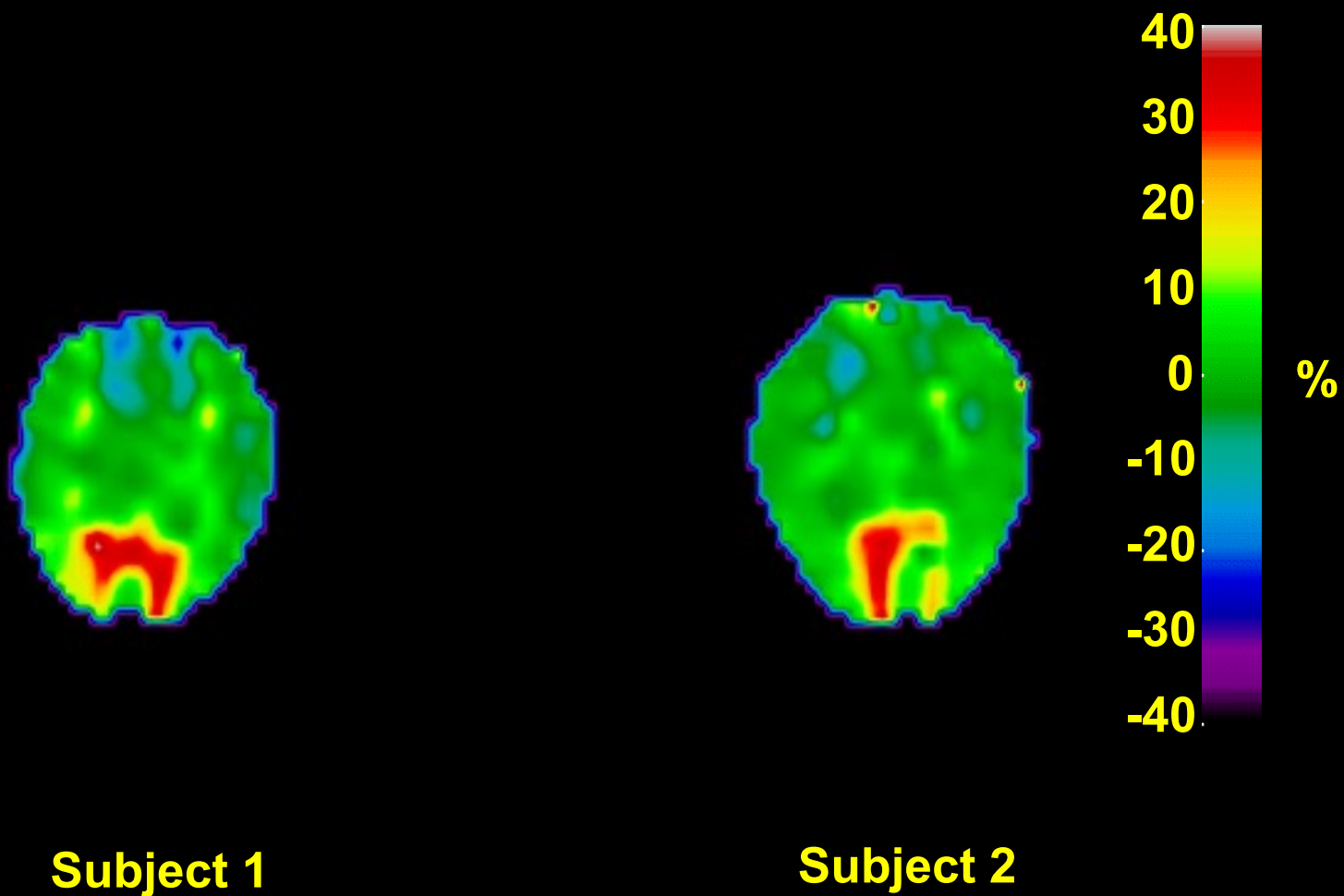

# Quantitative Measurements of Cerebral Metabolic Rate of Oxygen (CMRO<sub>2</sub>) Using MRI: A Volunteer Study

Hongyu AN<sup>1</sup>, Weili LIN<sup>2</sup>, Azim CELIK<sup>3</sup>, Yueh Z. LEE<sup>4</sup>

<sup>1</sup>Washington University, 600 Airport Road, Chapel Hill, NC USA; <sup>2</sup>UNC-Chapel Hill, Department of Radiology, CB#7515, Chapel Hill, NC USA; <sup>3</sup>GE Medical Systems; <sup>4</sup>UNC-Chapel Hill;

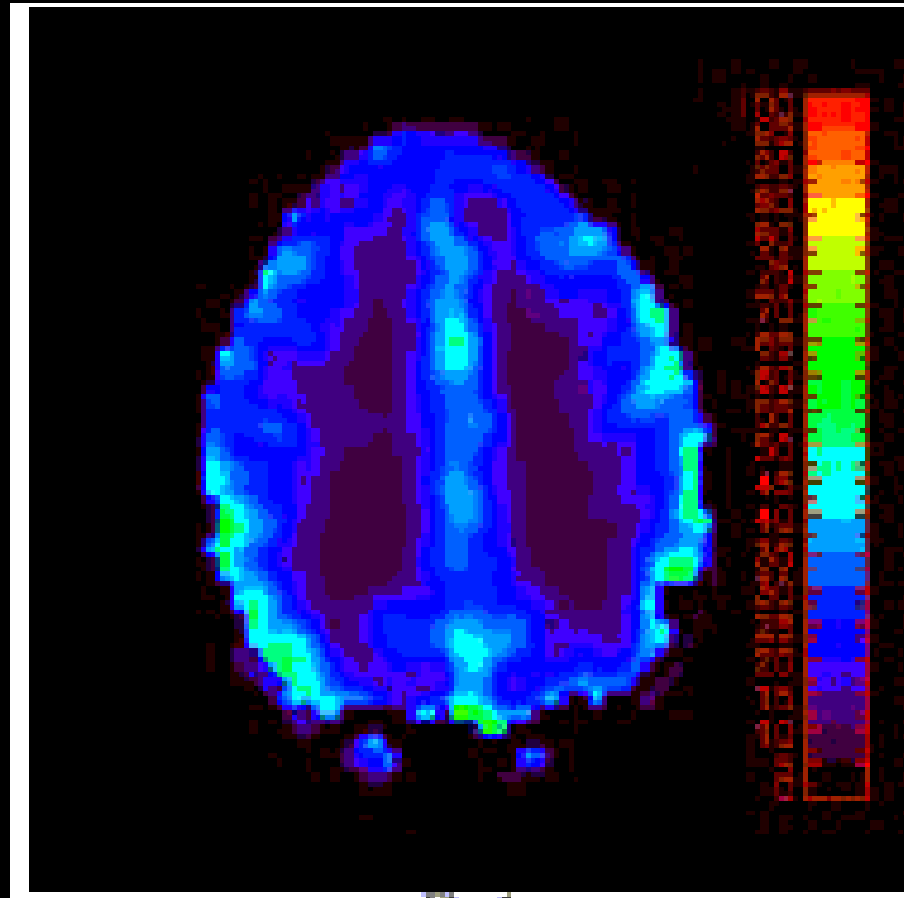
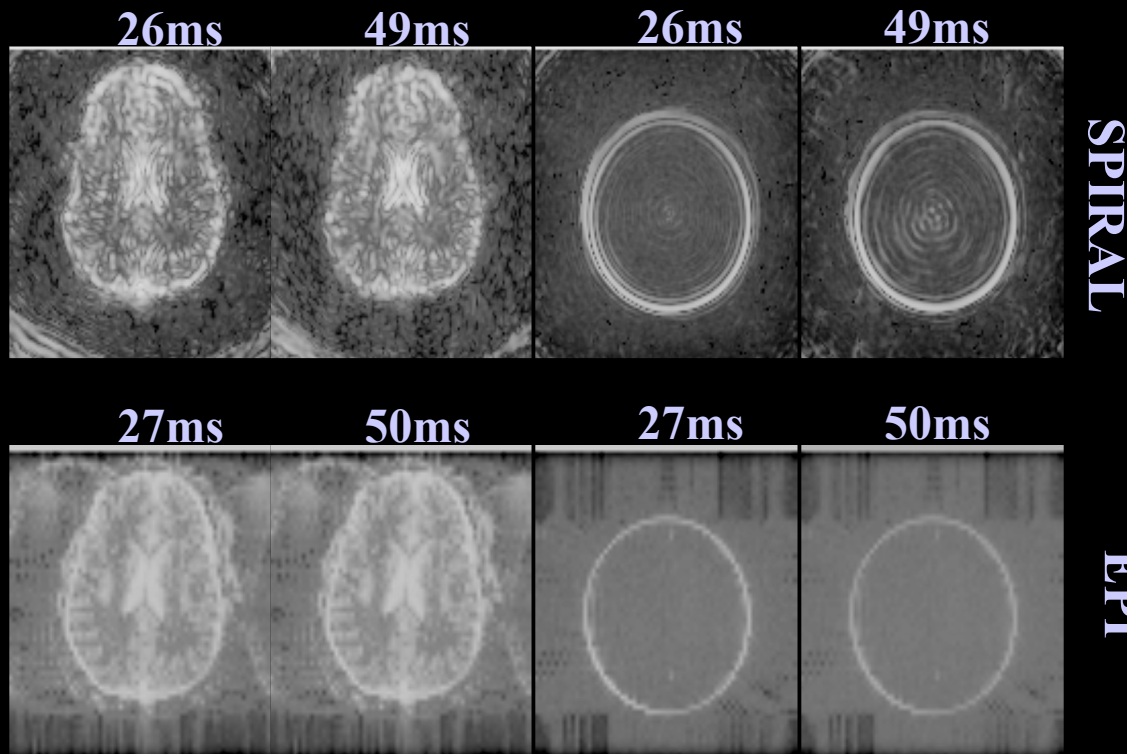

Figure 1

Higher Signal to Noise **in a single image** does not necessarily translate to higher Signal to Noise **over time**.

### Temporal vs. Spatial SNR- 3T



# 0.25 Hz Breathing at 3T

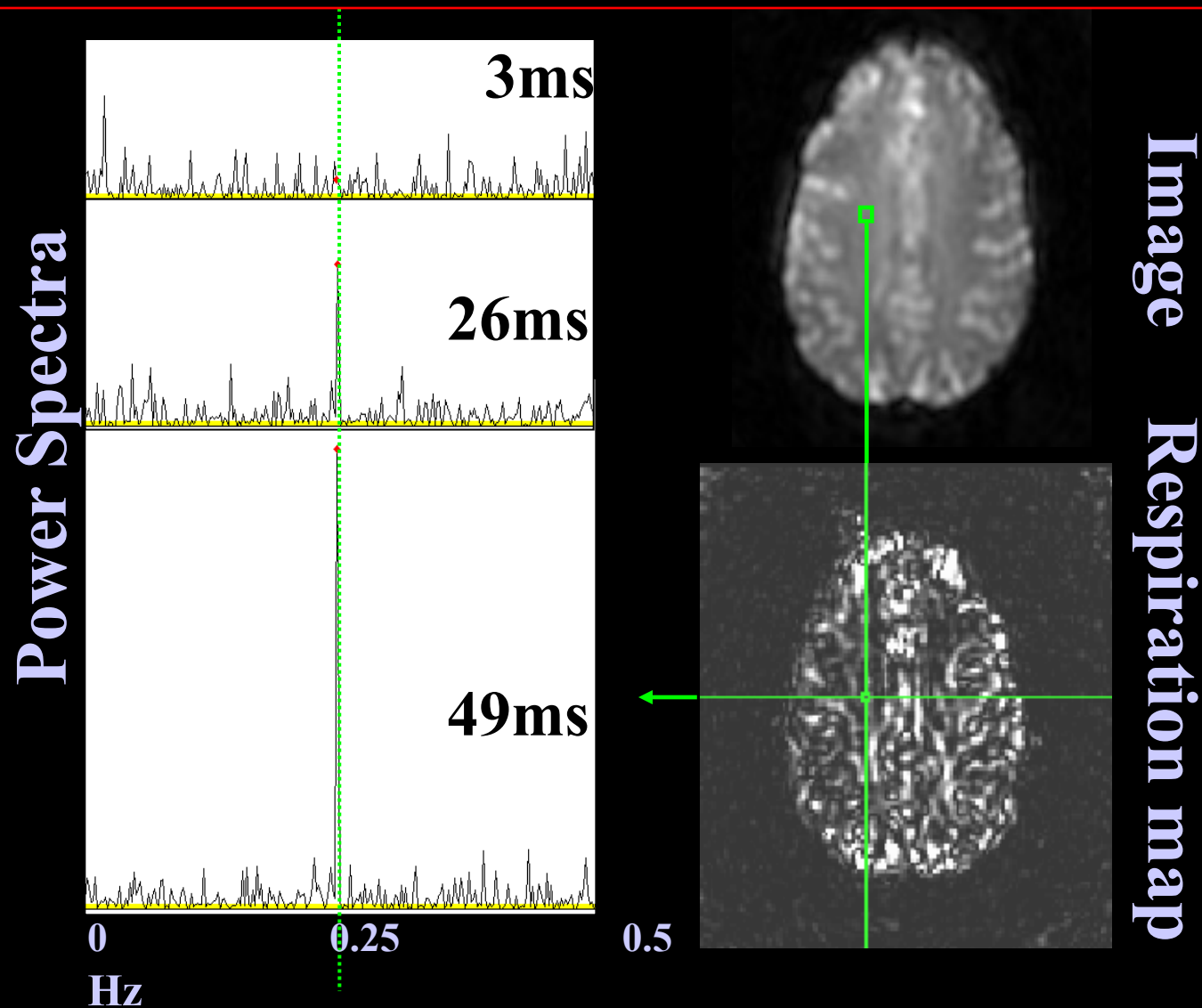



# 0.68 Hz Cardiac rate at 3T

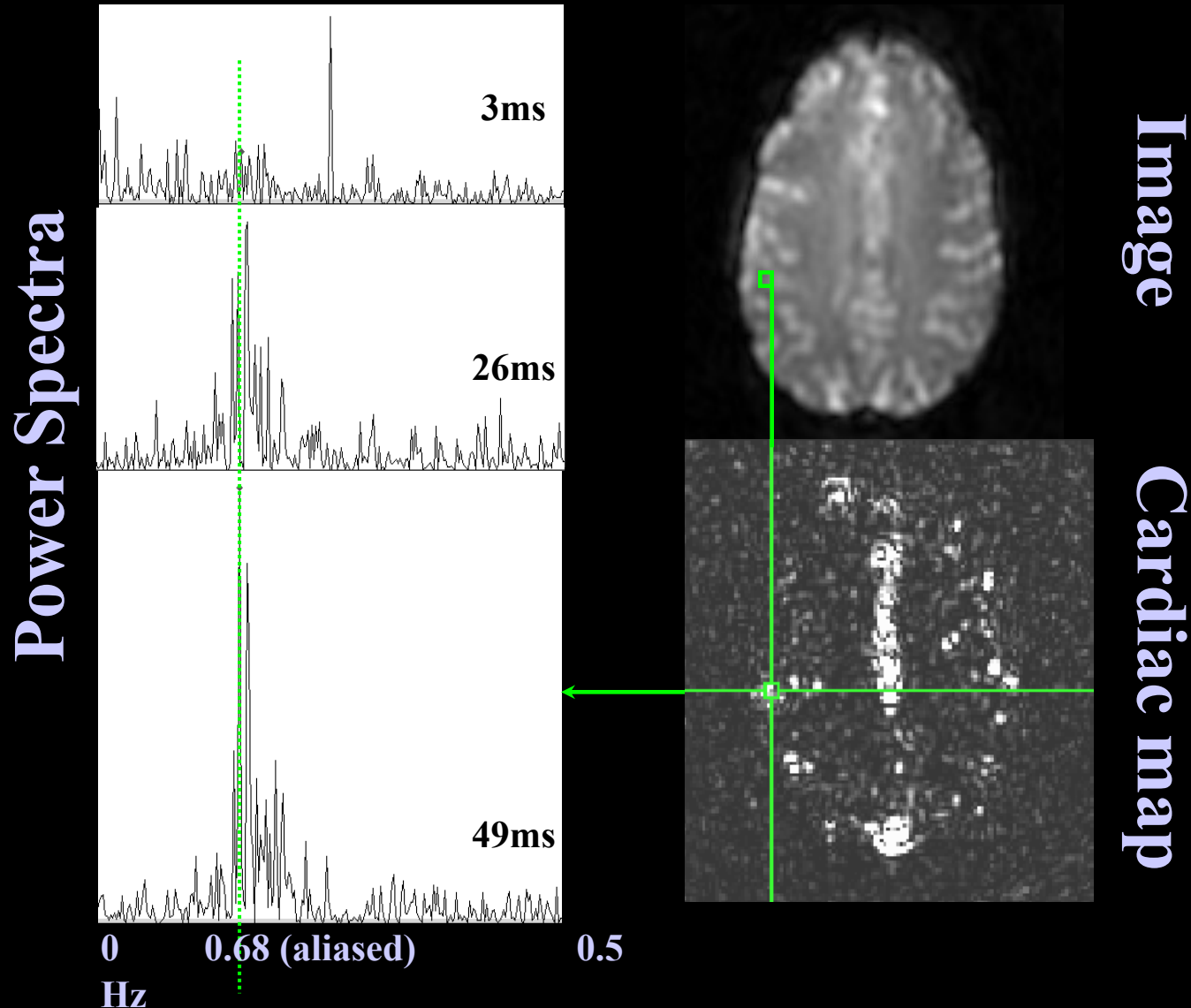

# Temporal S/N vs. Image S/N

## PHANTOMS

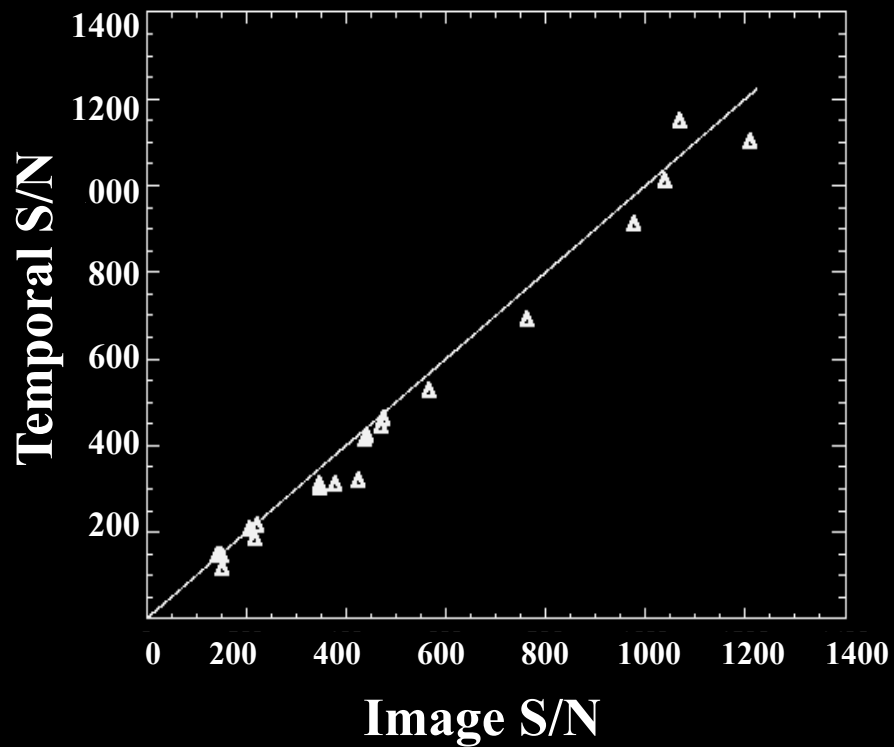

## SUBJECTS

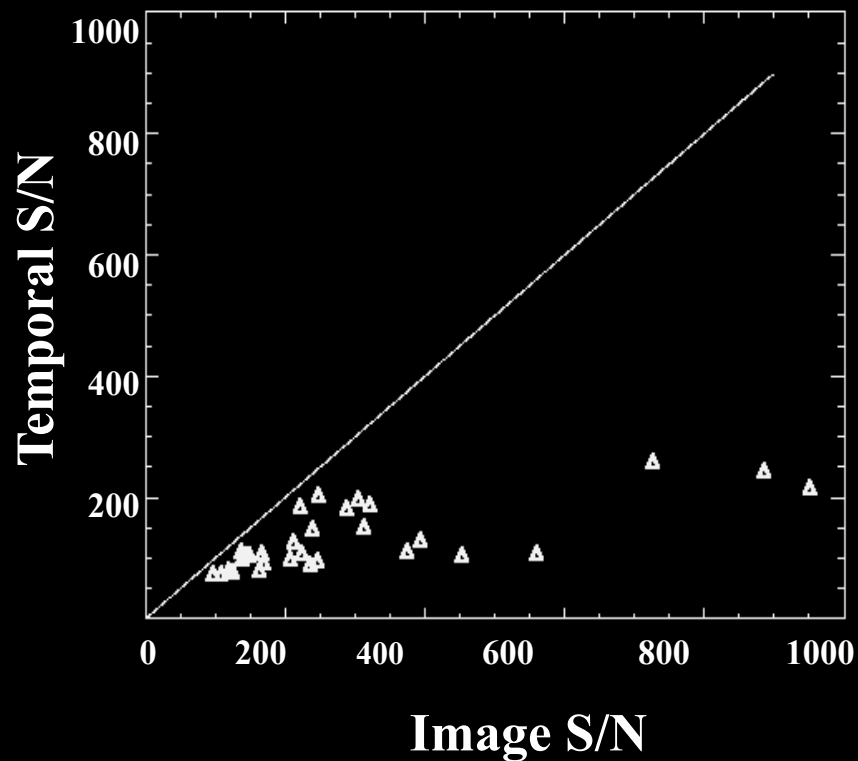

# Continuously Growing Activation Area

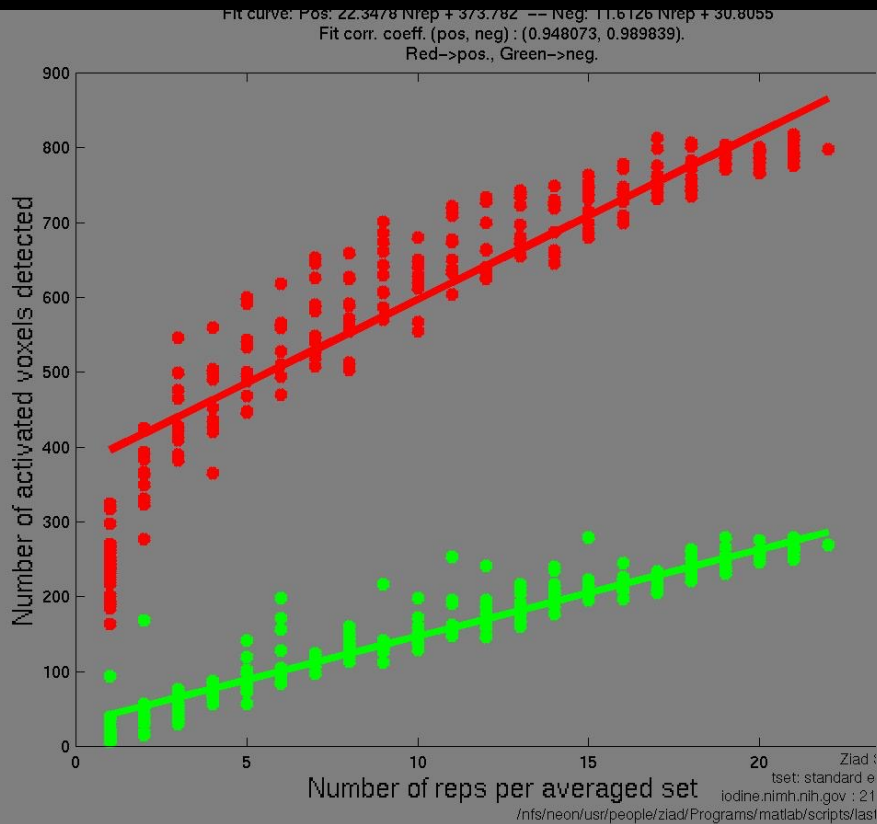

# CC Histogram

Inflection Point

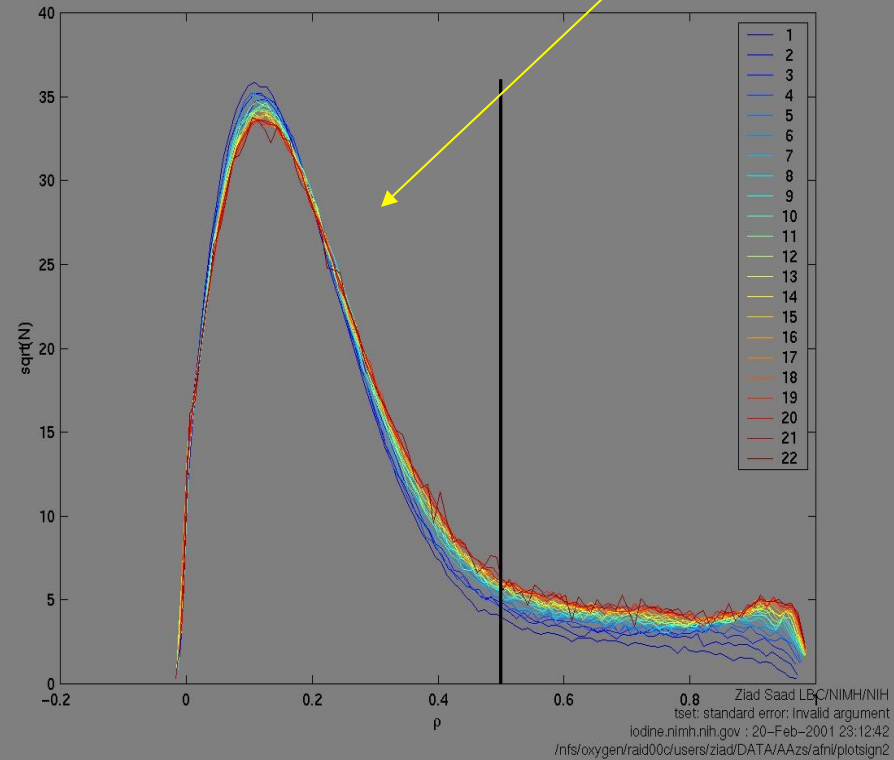

Ziad Saad, et al

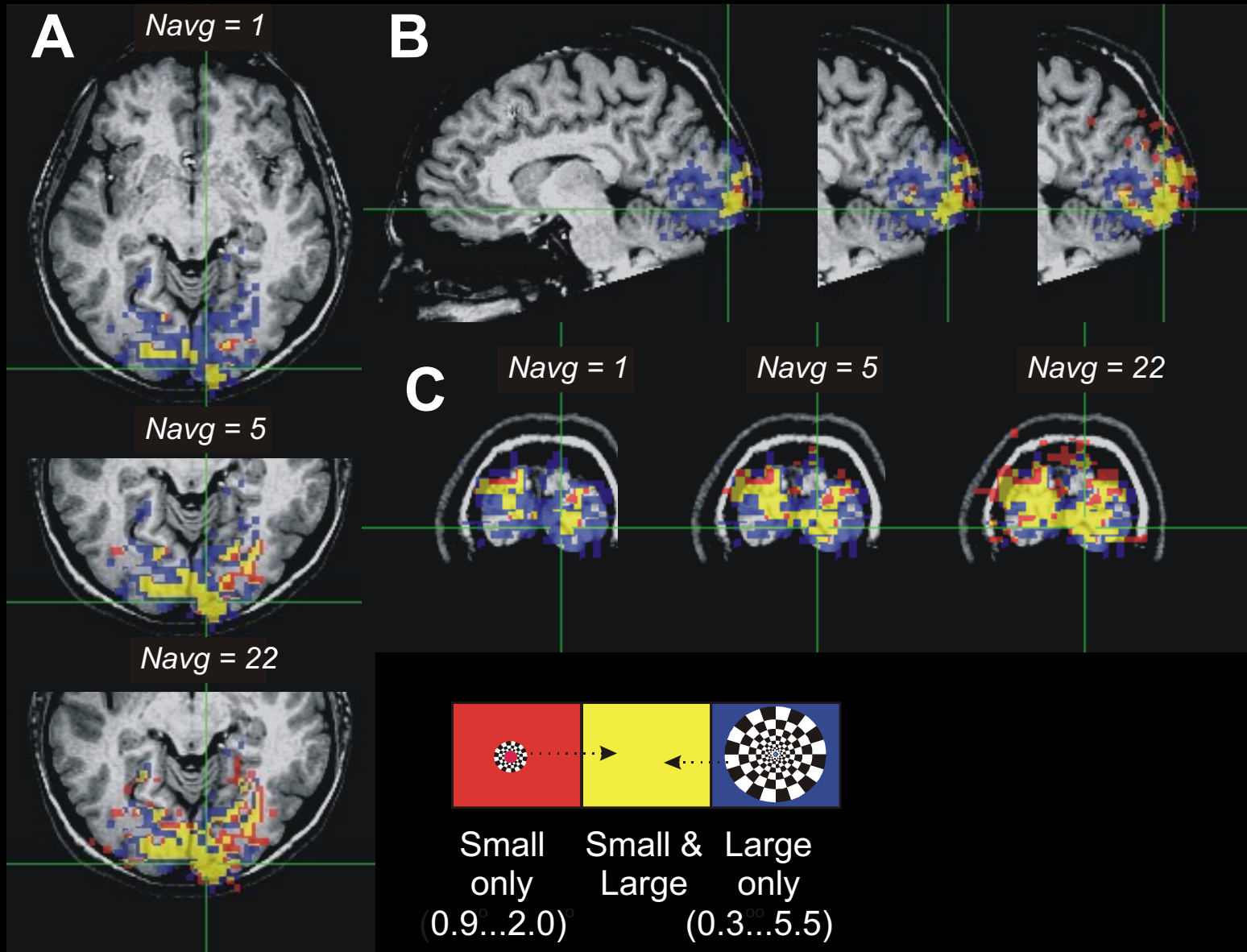

- Contrast in fMRI

*Hemodynamic Specificity*

- **The Hemodynamic Transfer Function**

*Location, Latency, Magnitude, Linearity*

- Best Results So Far

*Temporal Resolution, Spatial Resolution*

- Neuronal Activation Input Strategies

*Block Design*

*Phase and Frequency Encoding*

*Orthogonal Designs*

*Parametric Designs*

*Event-Related Designs*

*Free Behavior Designs*

# Hemodynamic Transfer Function

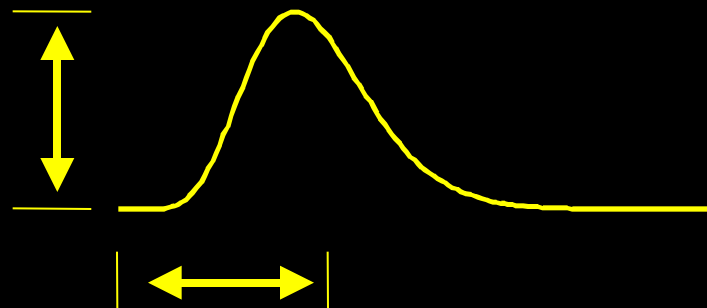
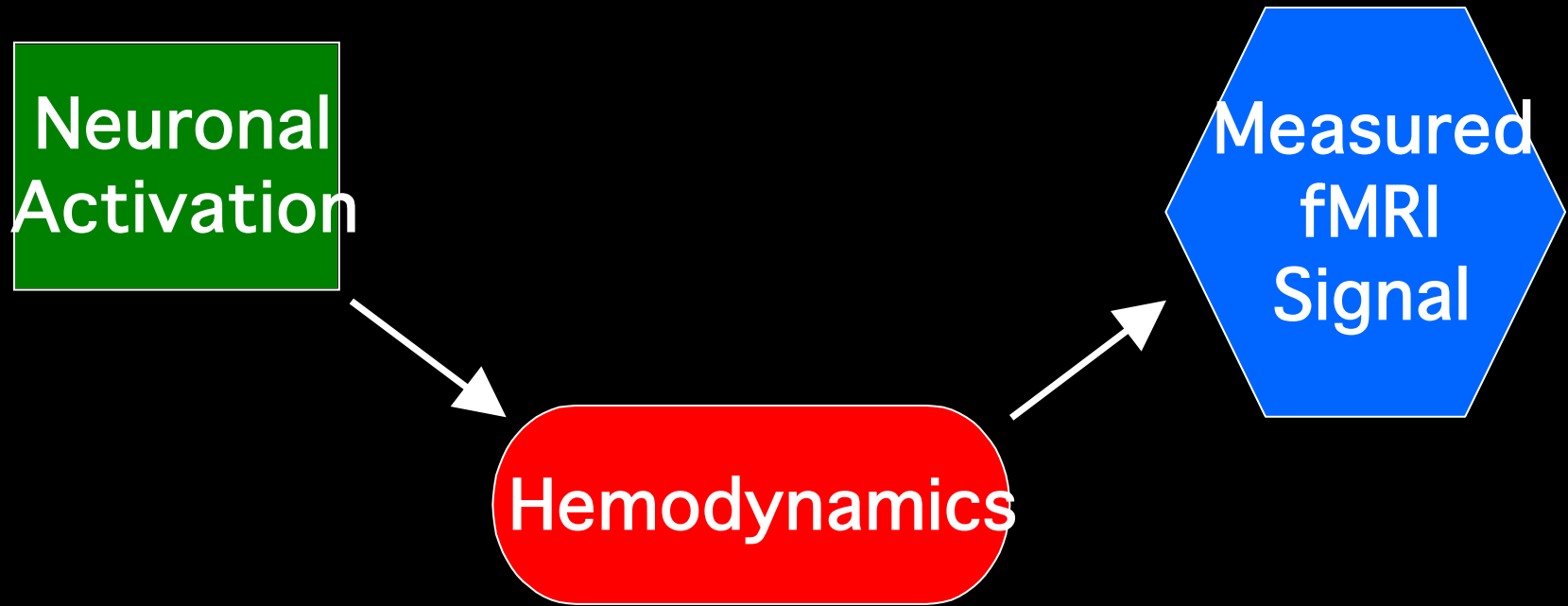

Physiologic Factors

MRI Signal

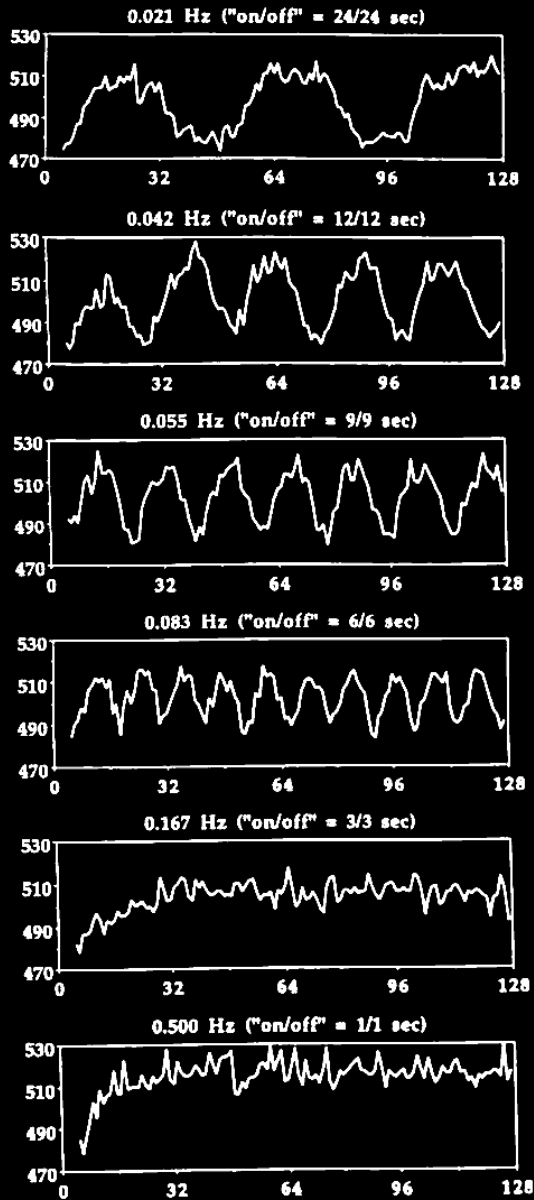

Time (seconds)

Relative Activation - Induced  
MR Signal Change

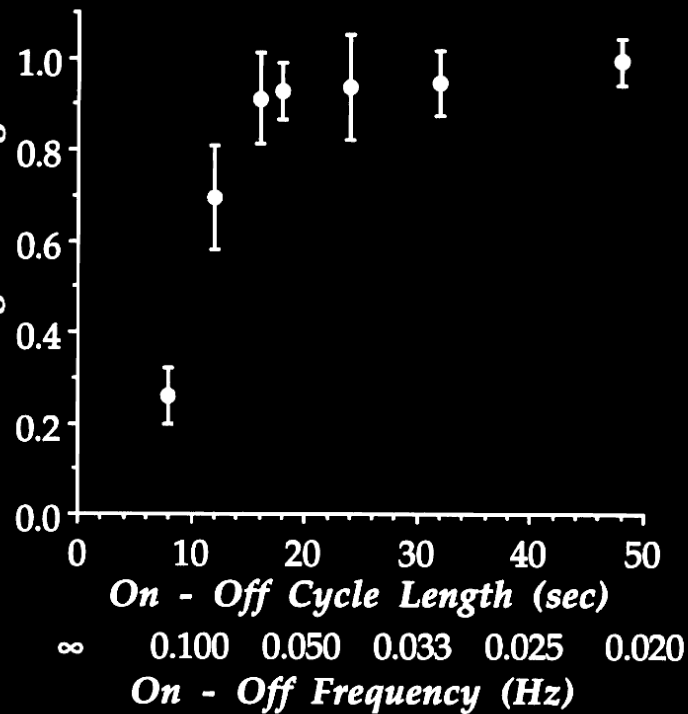

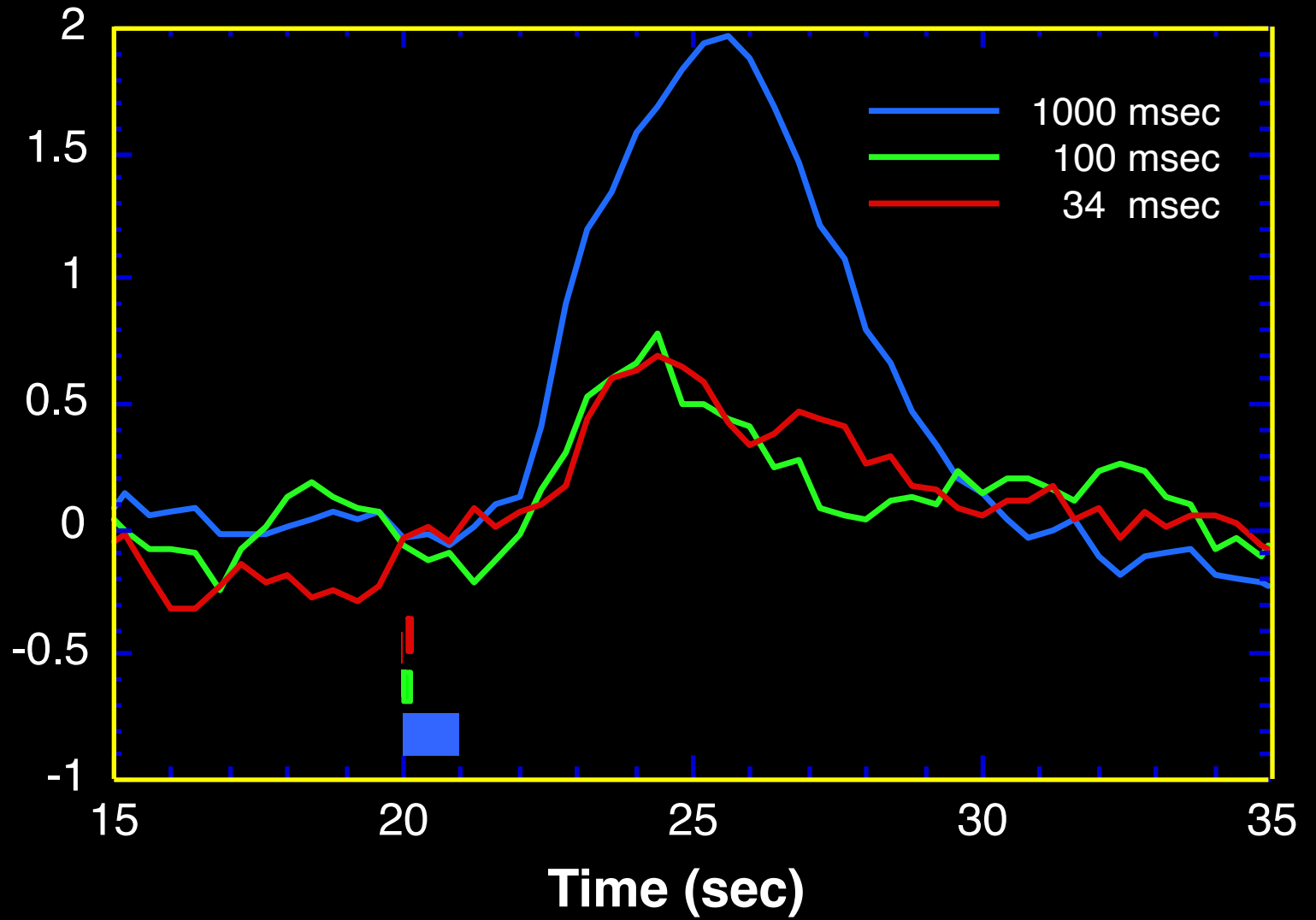



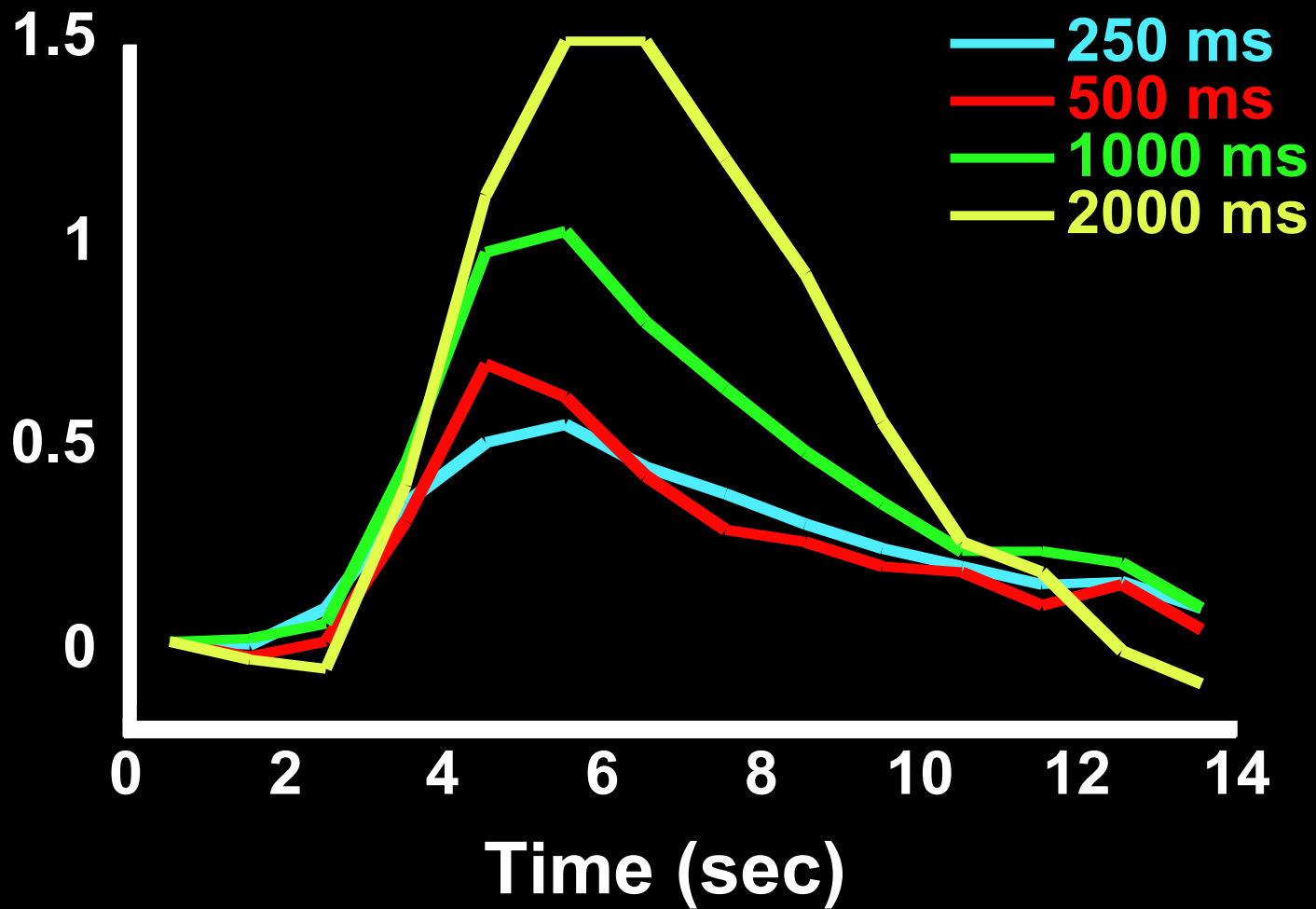

**Latency**

**Magnitude**

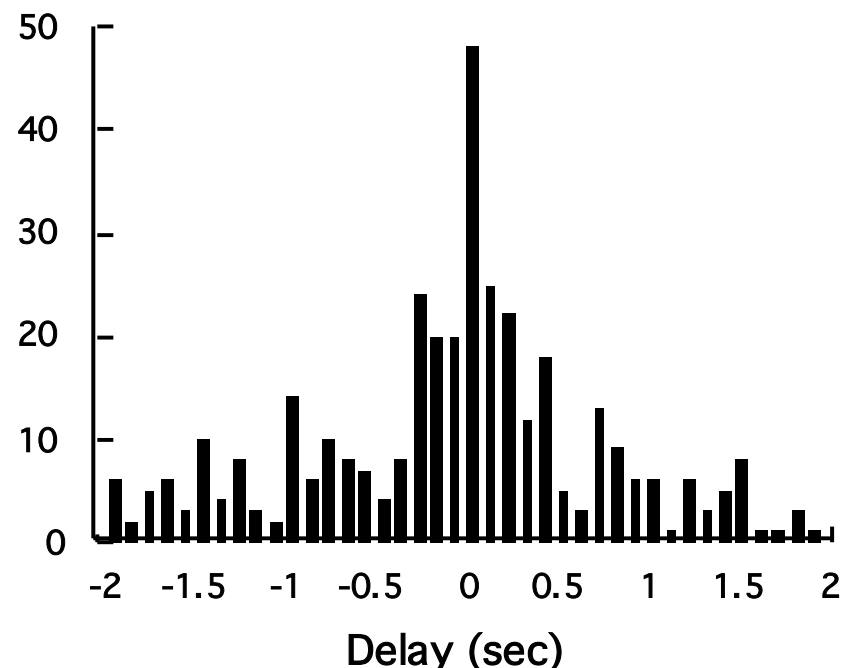
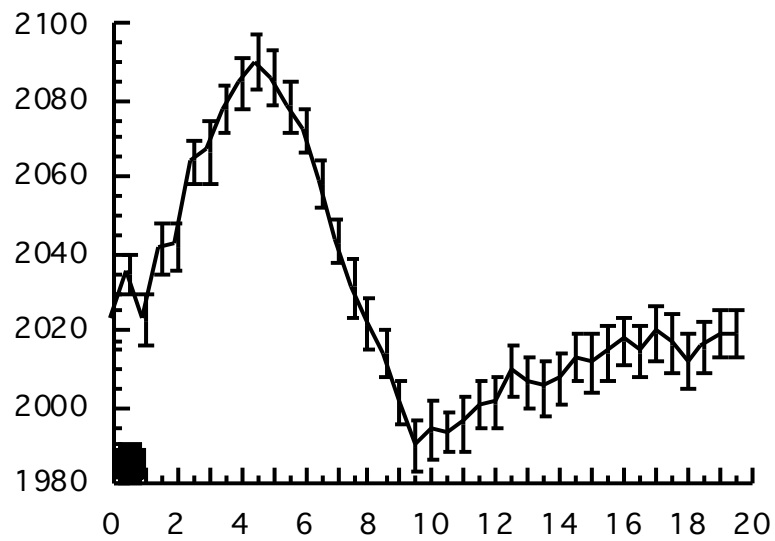
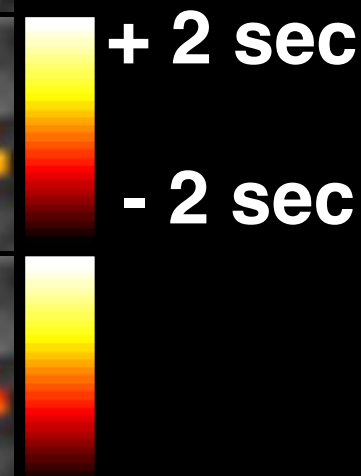
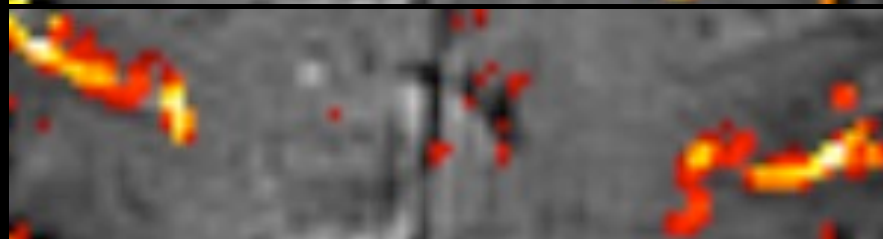
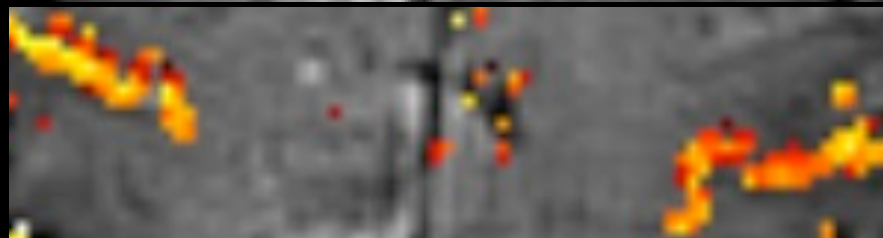

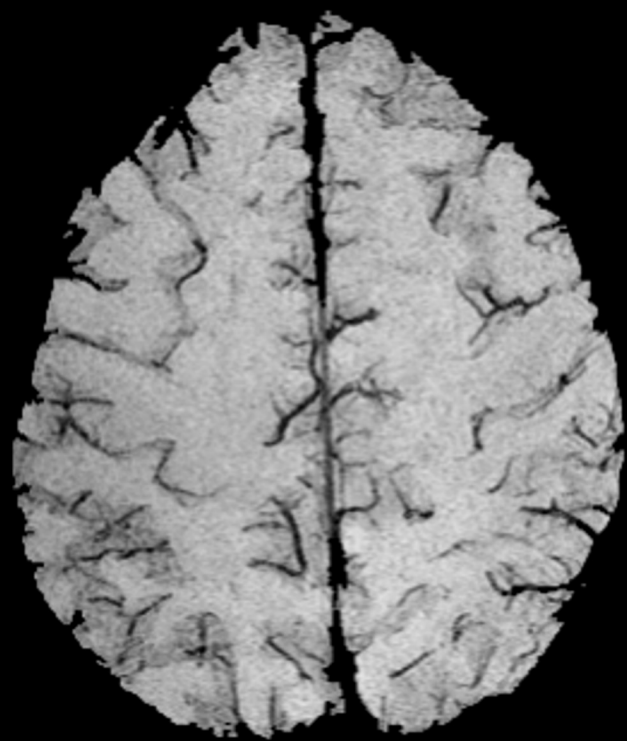

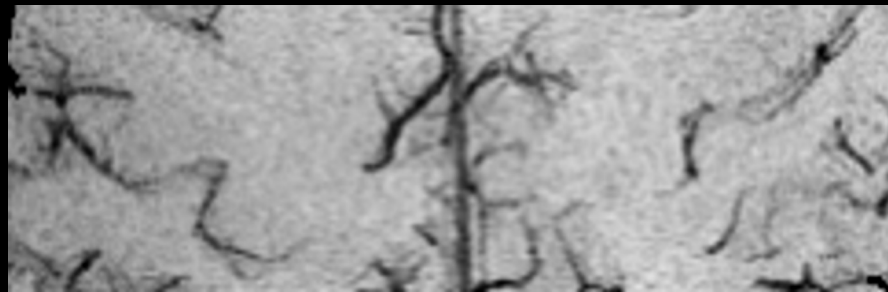
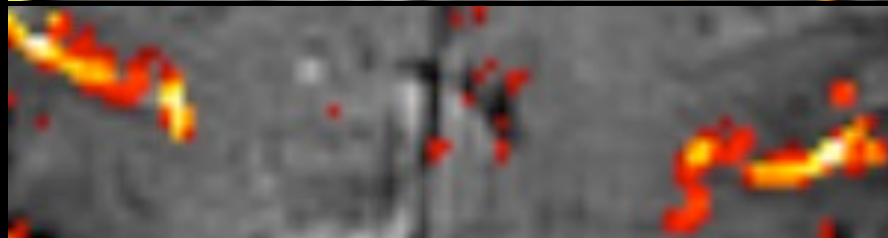
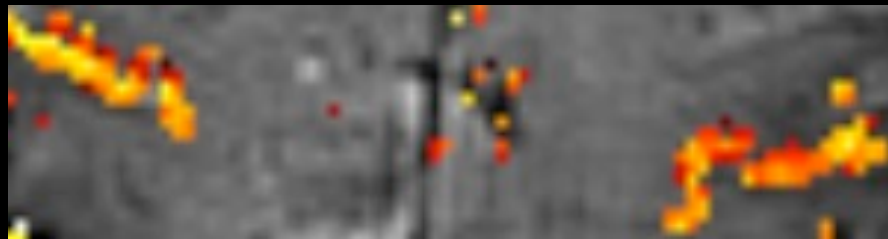
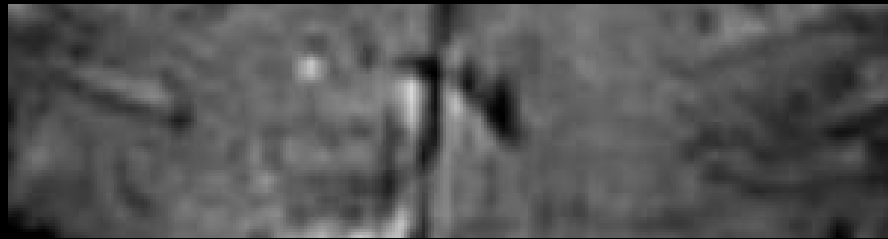

# Observed Responses

*measured*

*ideal (linear)*

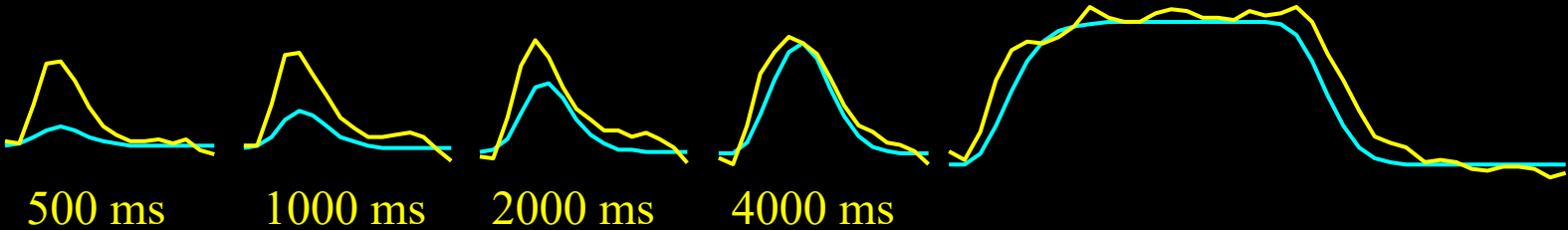
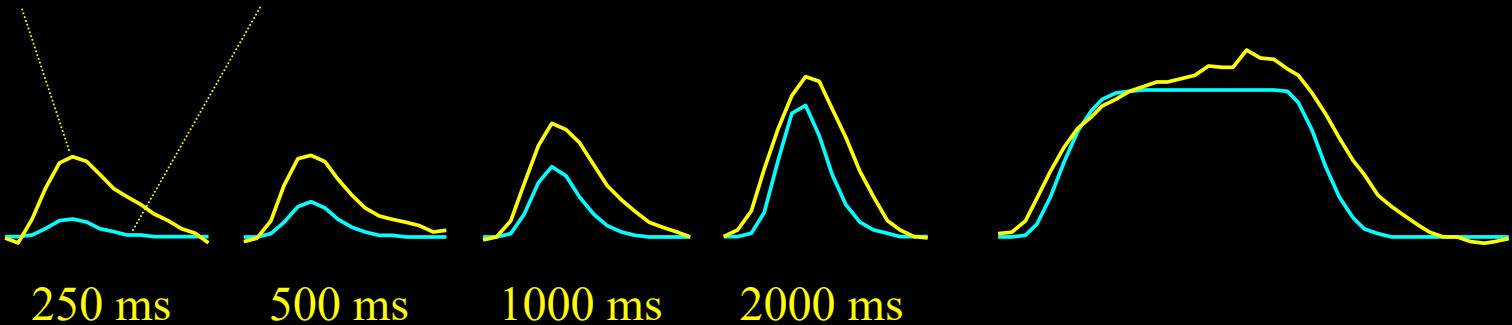

# BOLD response is nonlinear

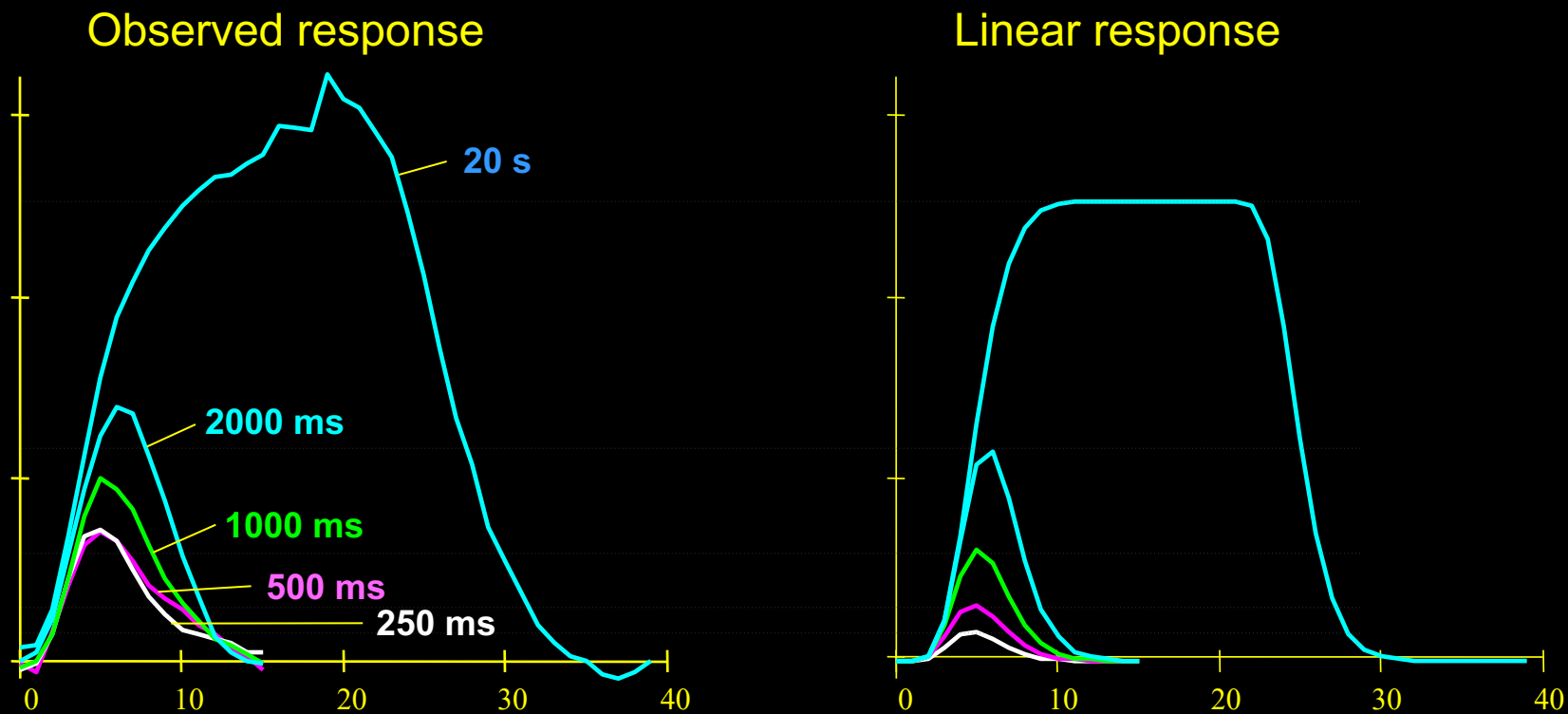

*Short duration stimuli produce larger responses than expected*

# Results — visual task

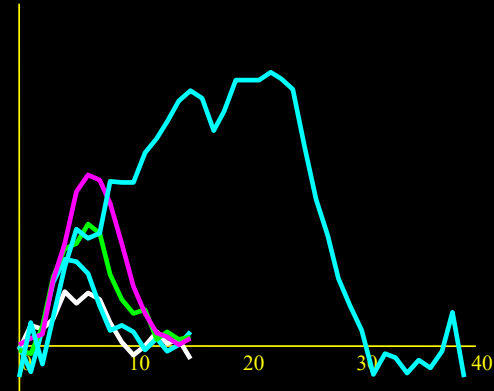
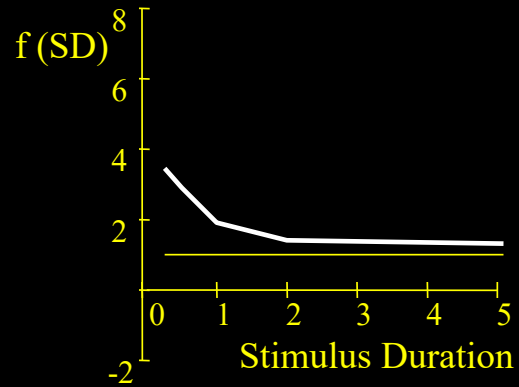
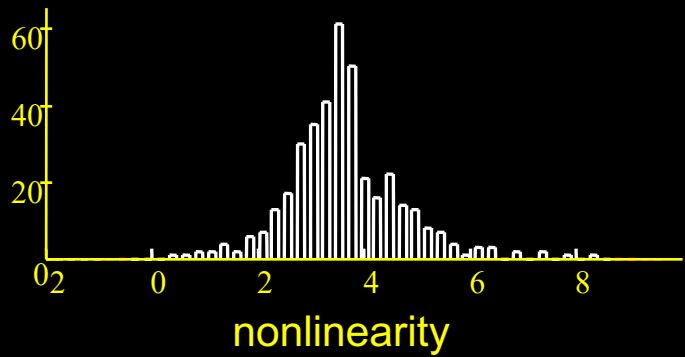
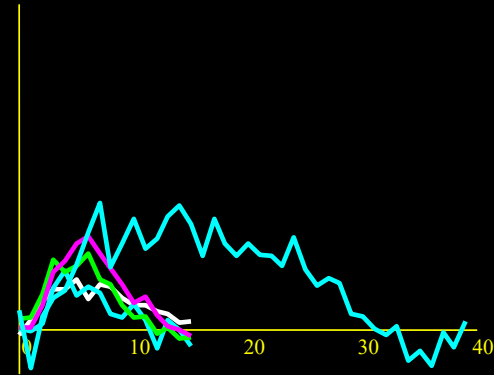
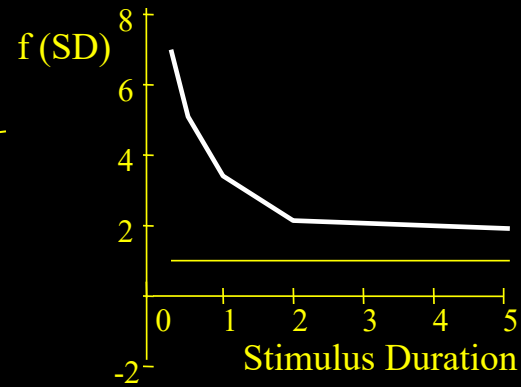
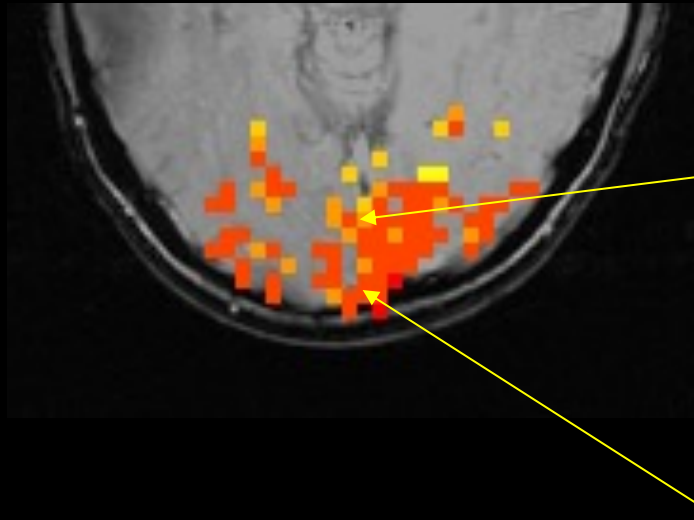

# Results — visual task

Nonlinearity

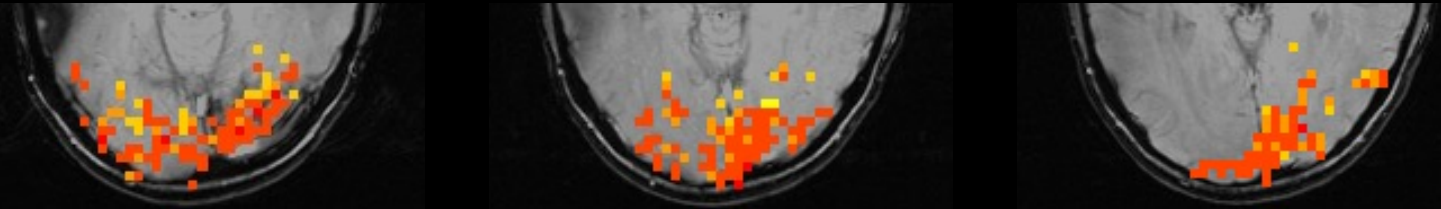

Magnitude

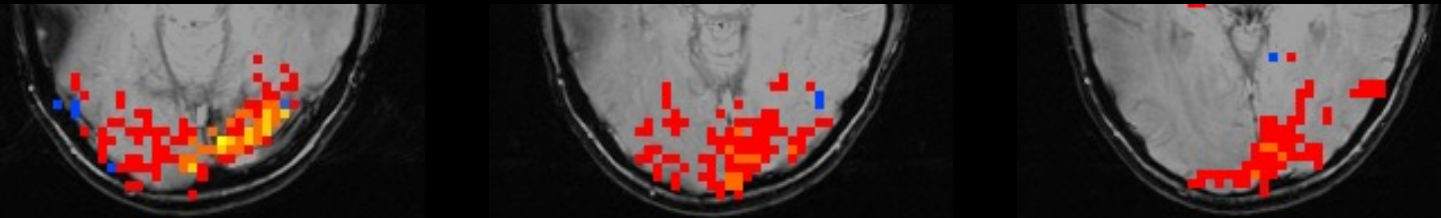

Latency

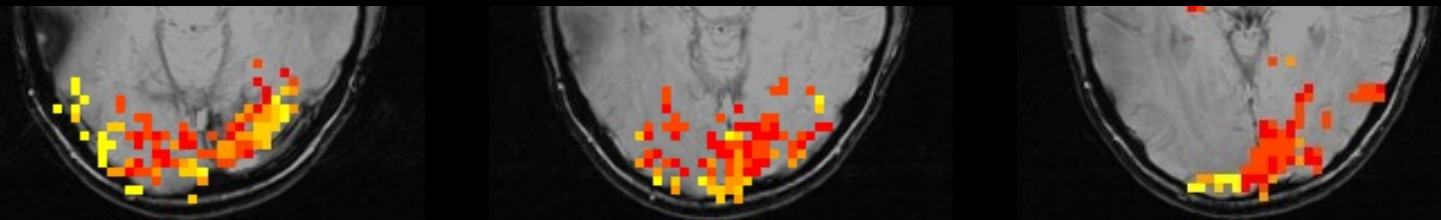



# Results — motor task

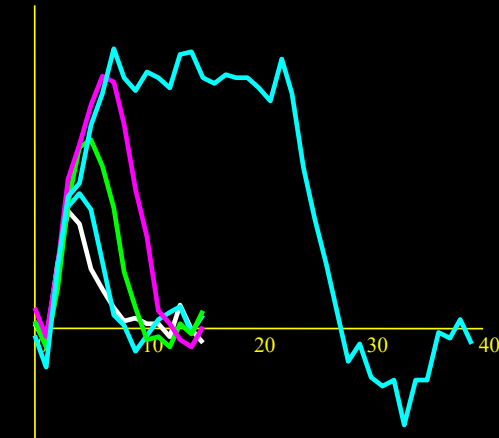
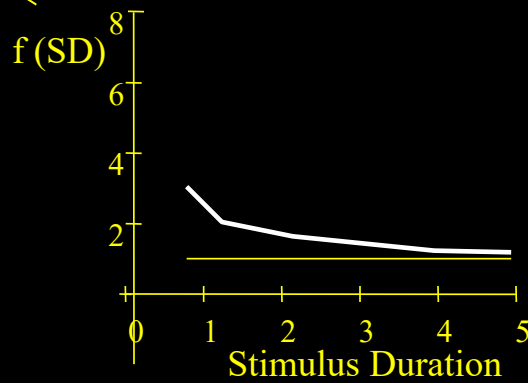
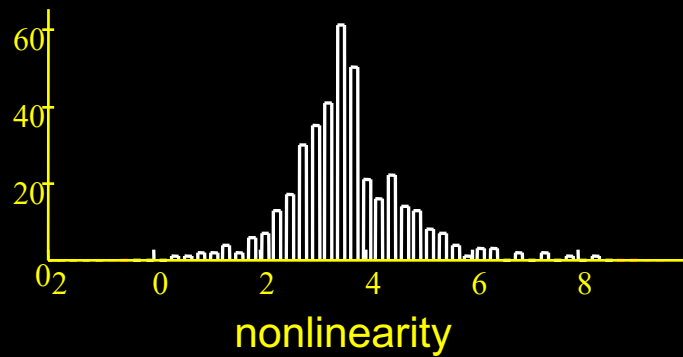
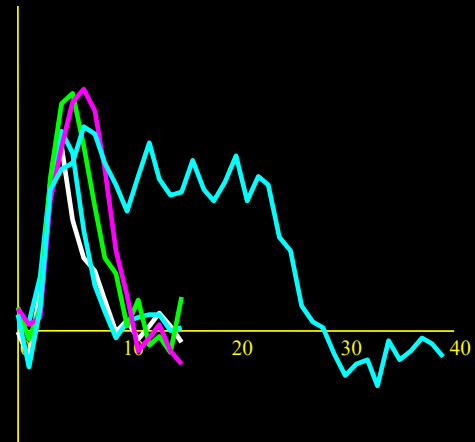
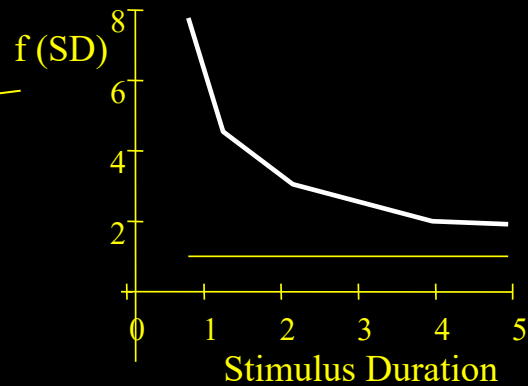
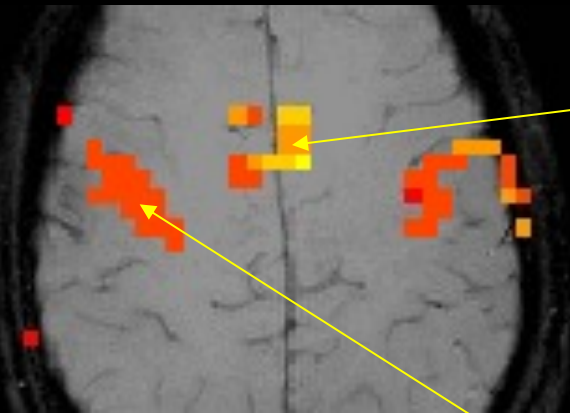

# Results — motor task

Nonlinearity

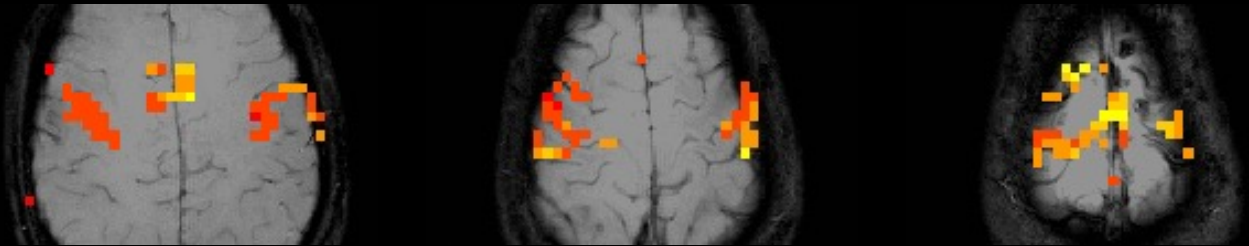

Magnitude

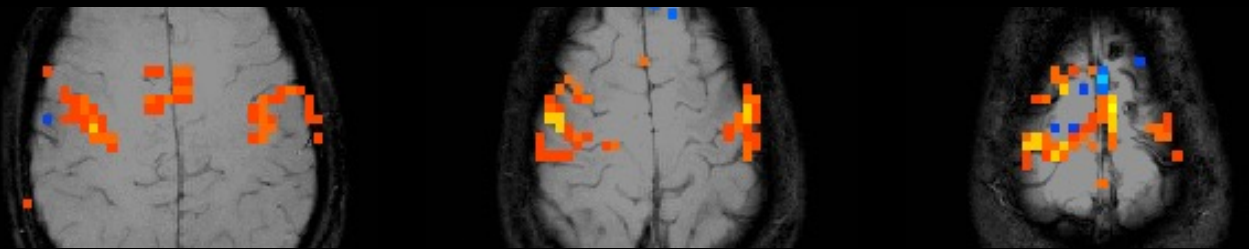

Latency

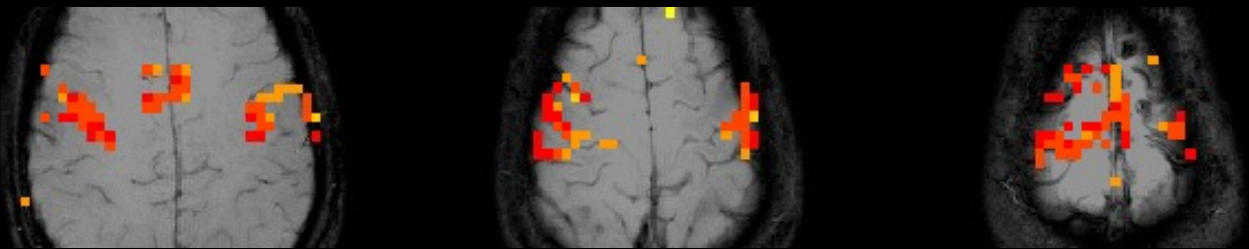

# Different stimulus “ON” periods

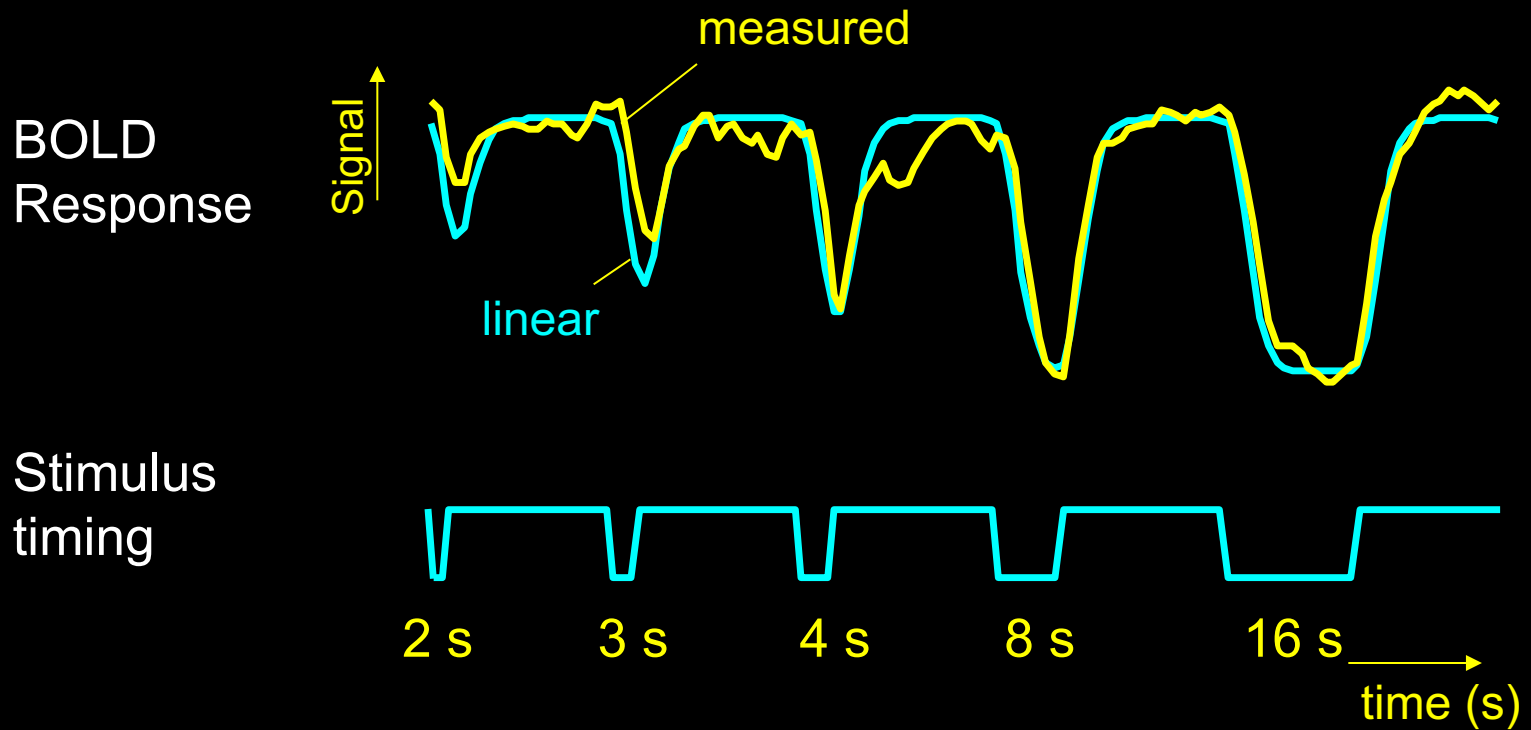

*Brief stimulus OFF periods produce smaller decreases than expected*

# Sources of this Nonlinearity

- Neuronal

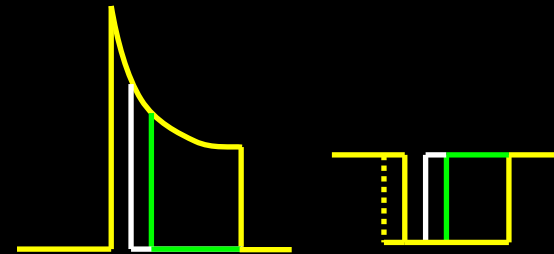
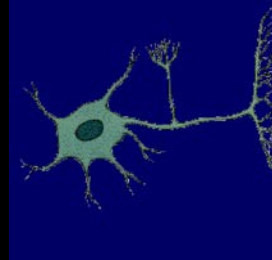

- Hemodynamic

- Oxygen extraction
- Blood volume dynamics

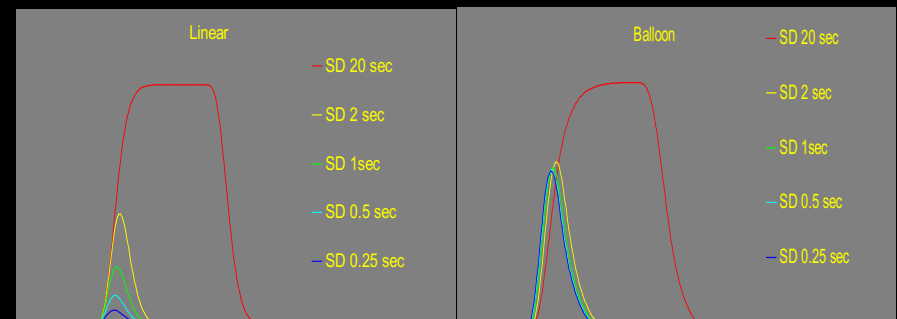
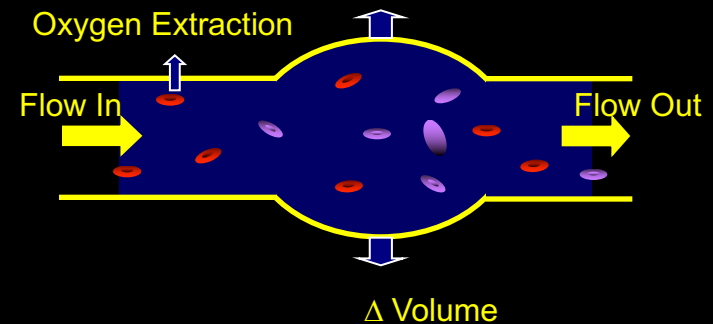

# Sources of this Nonlinearity

- Neuronal

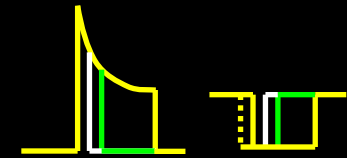
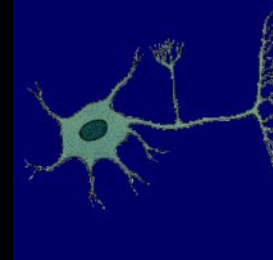

- Hemodynamic

- Oxygen extraction
- Blood volume dynamics

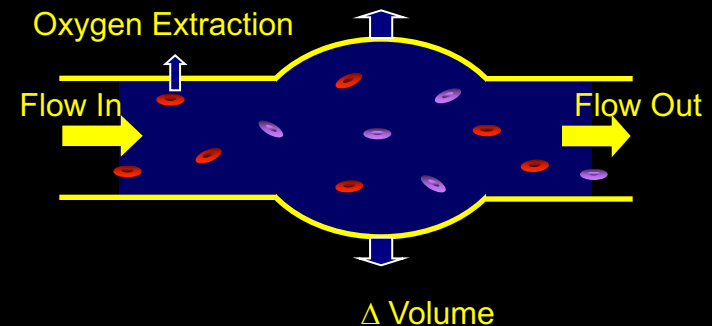

# BOLD Correlation with Neuronal Activity

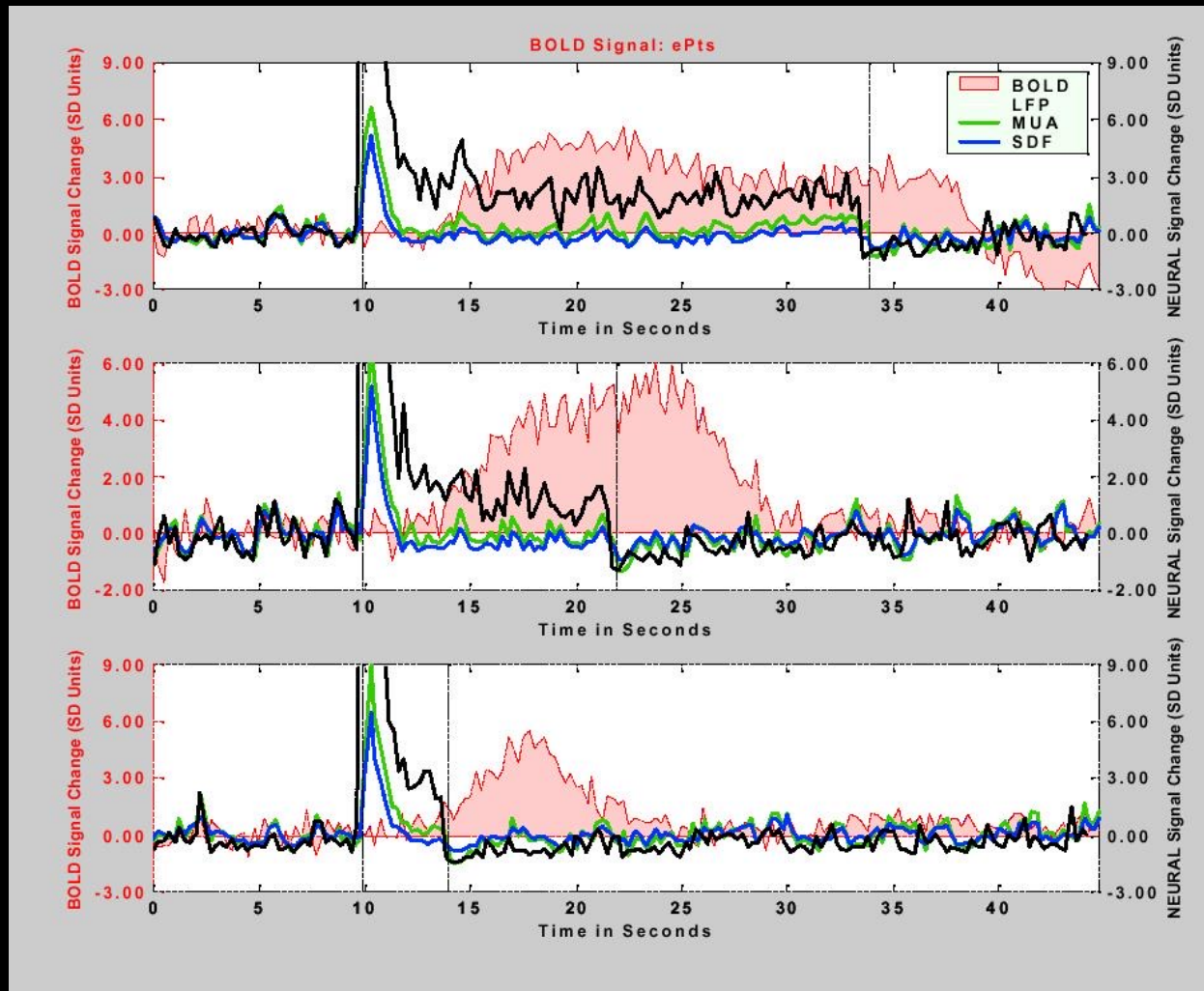

Logothetis et al. Nature, 412, 150-157

# BOLD Correlation with Neuronal Activity

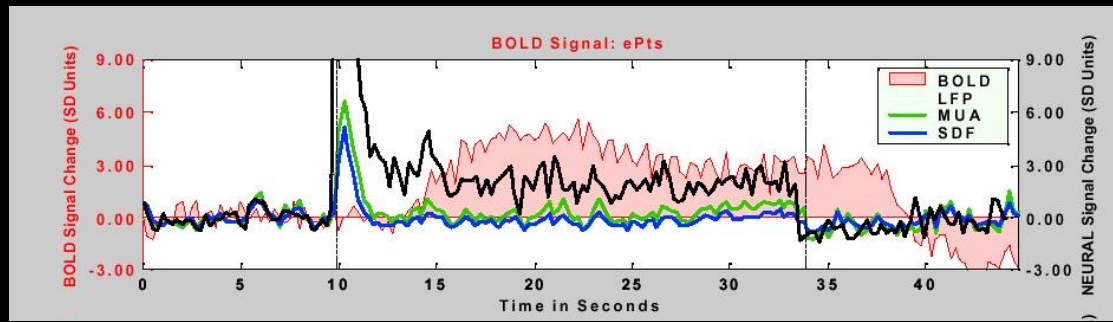

Logothetis et al. *Nature*, 412, 150-157

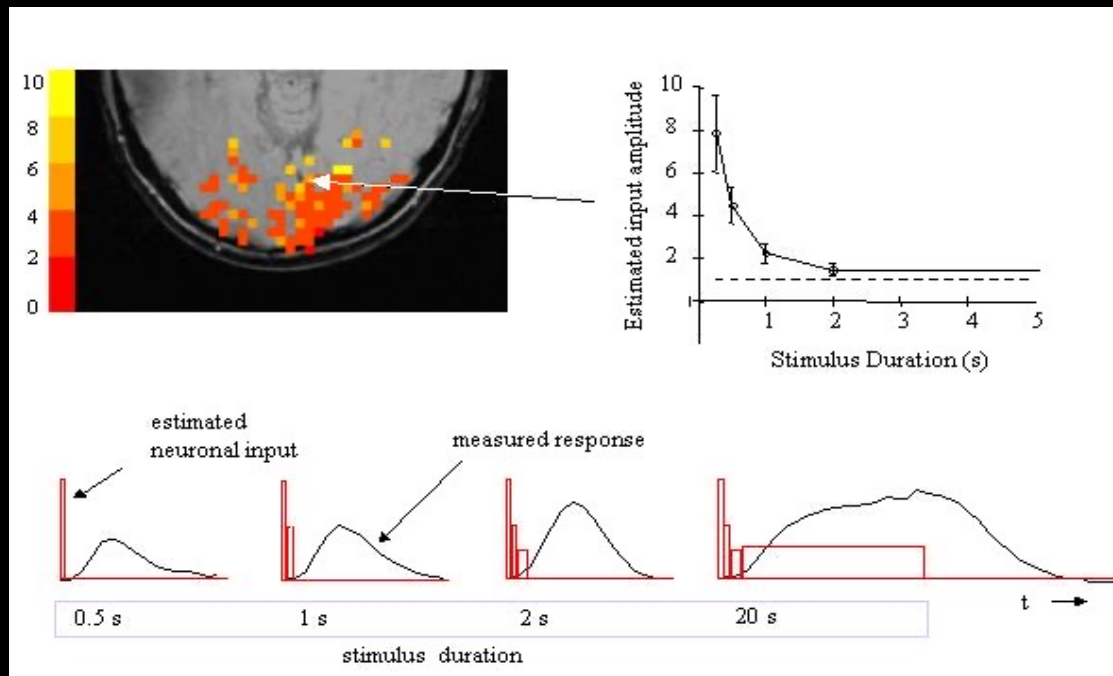

Bandettini and Ungerleider, *Nature Neuroscience*, 4, 864-866

Stationary grating

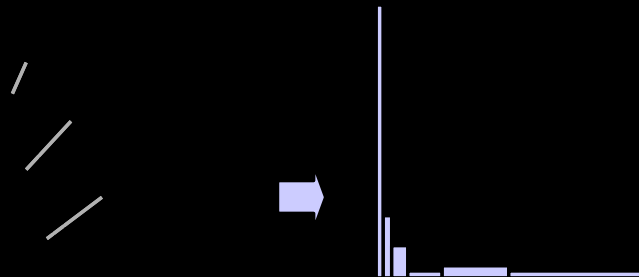

Contrast-reversing checkerboard

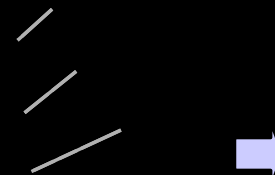



# Varying “ON” and “OFF” periods

- *Rapid event-related design with varying ISI*



# Varying “ON” and “OFF” periods

*Estimated  
Impulse Response*

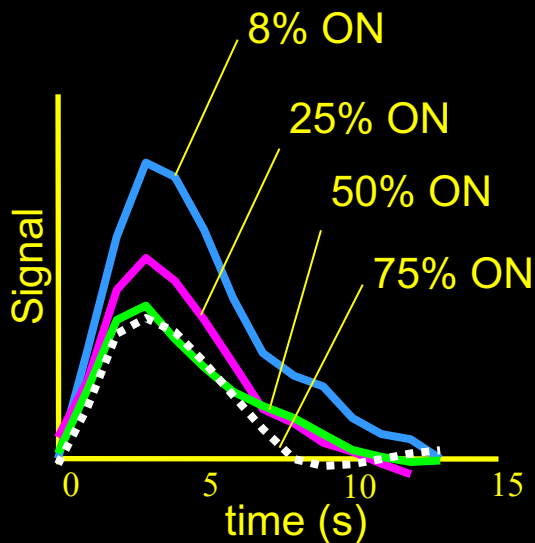

*Predicted Responses  
to 20 s stimulation*

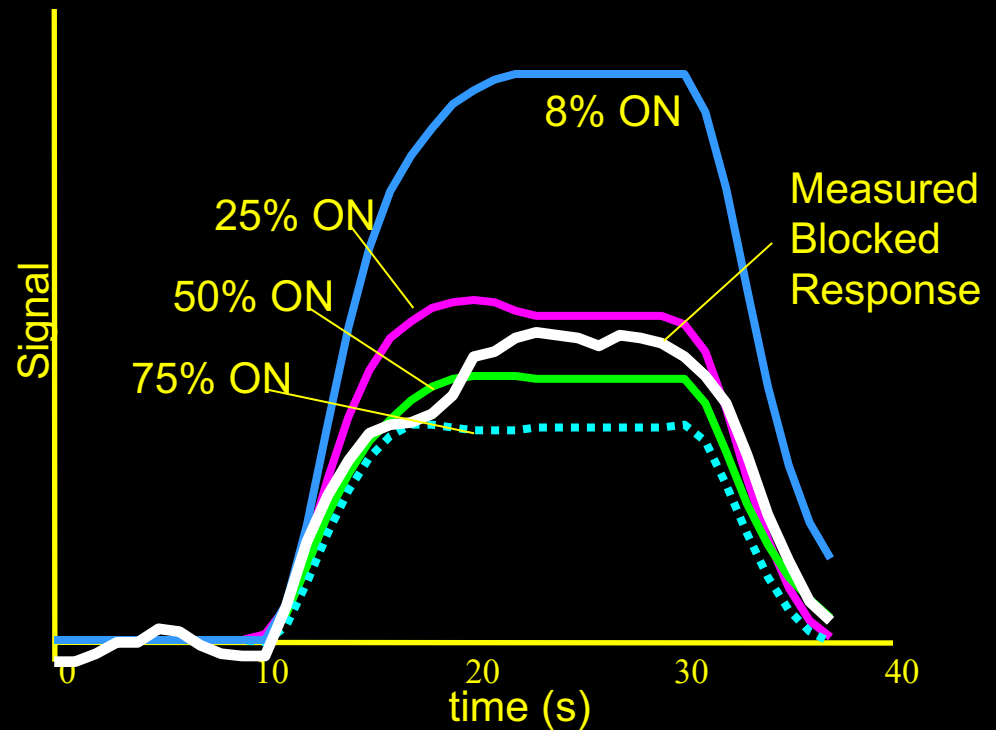

# Motor Cortex

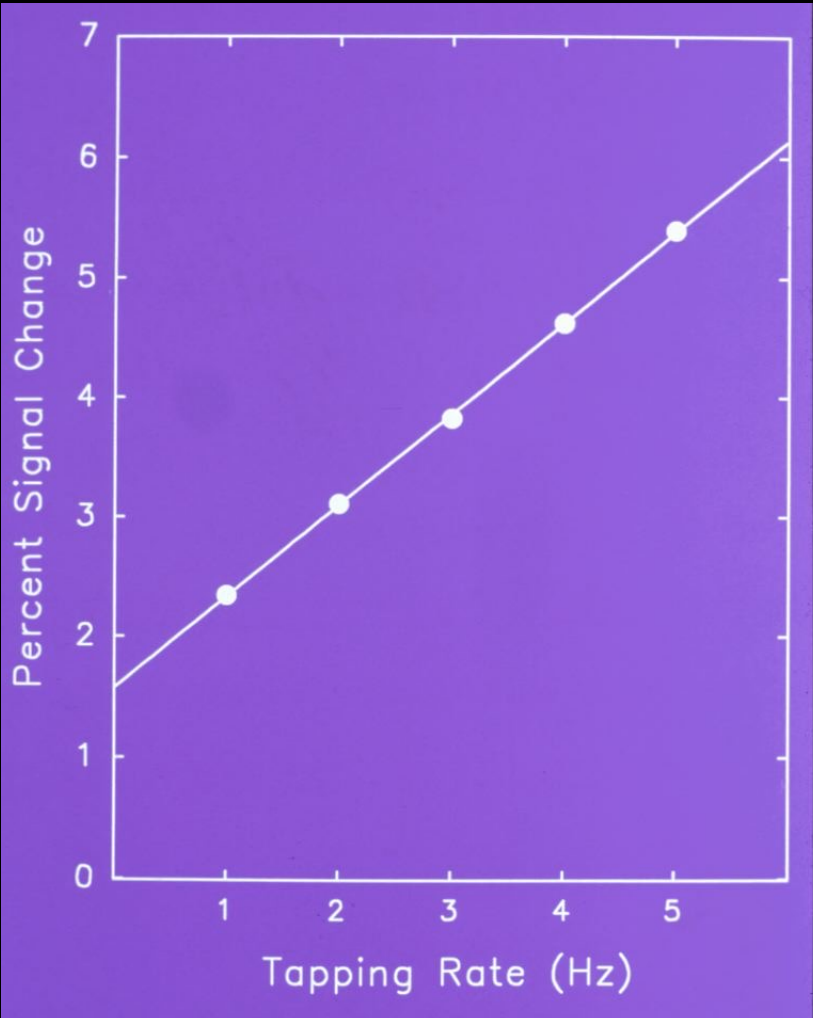

# Auditory Cortex

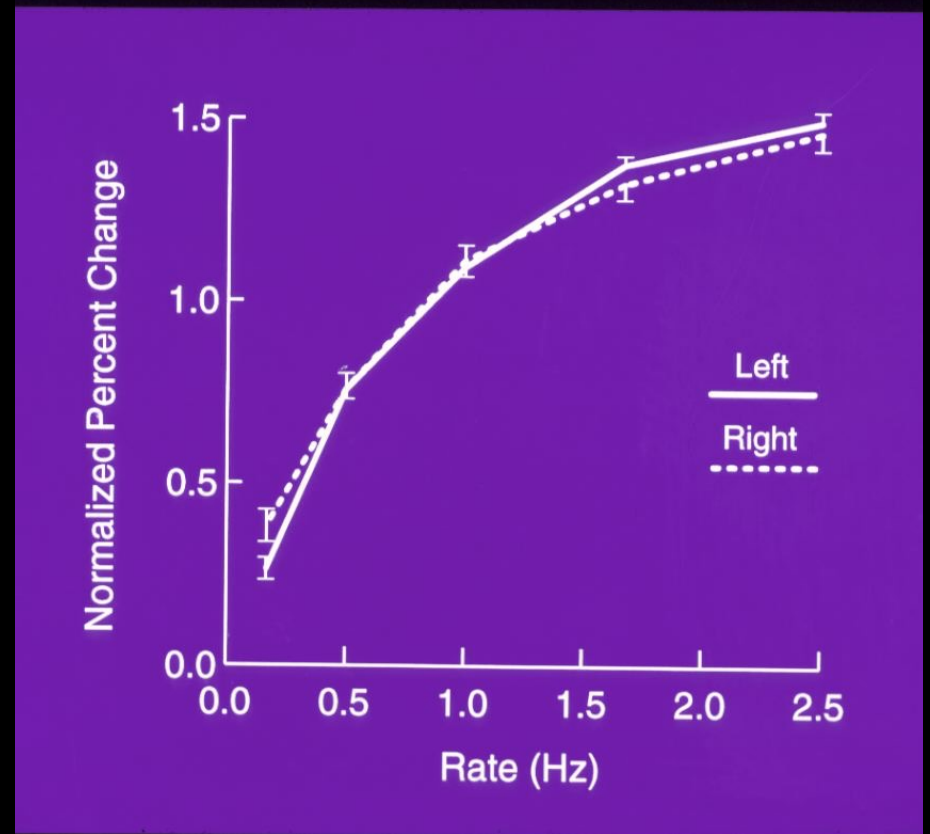

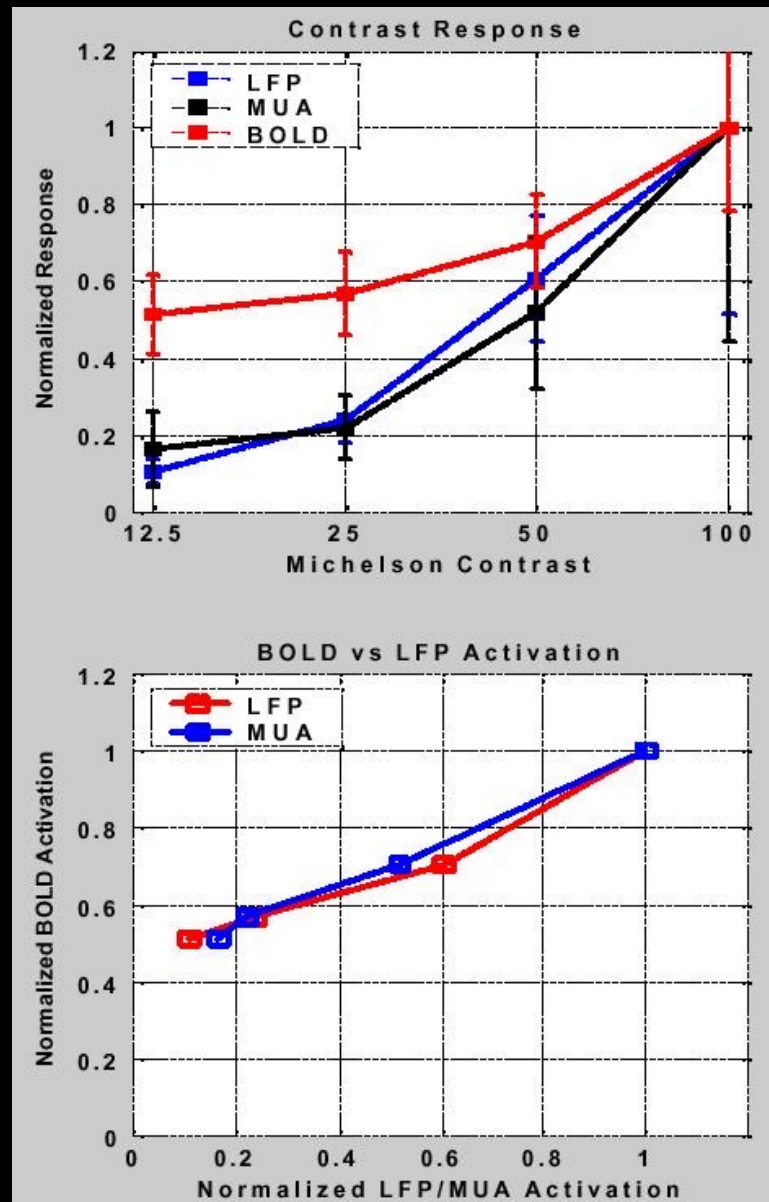

Logothetis et al. Nature, 412, 150-157

# Coherence tuning in MT+

Heekeren et al.

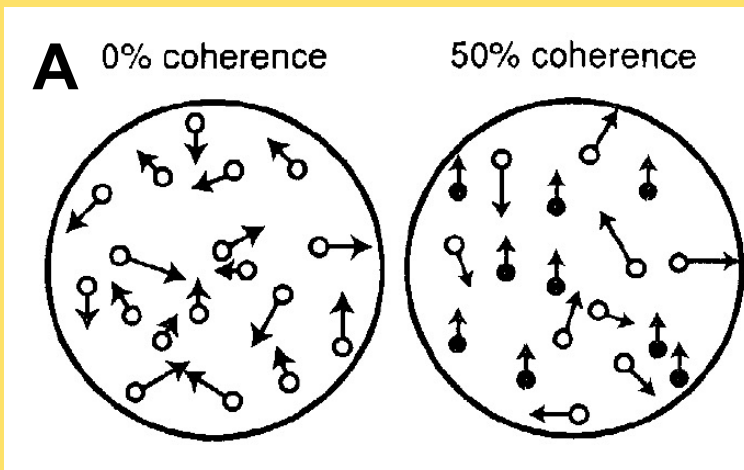

**B**

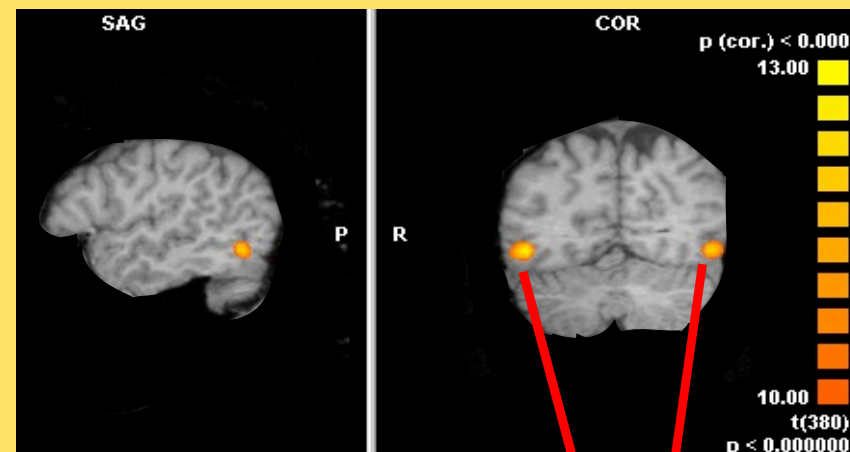

- Subjects had to indicate whether dots presented with differing degrees of coherence were moving left or right (A, figure modified from Newsome, 1997).
- MT+ was functionally localized (low contrast moving stimulus, LCMS, [B]).
- MT+ showed a nonmonotonic coherence tuning curve, with a local minimum around threshold levels.

**C**

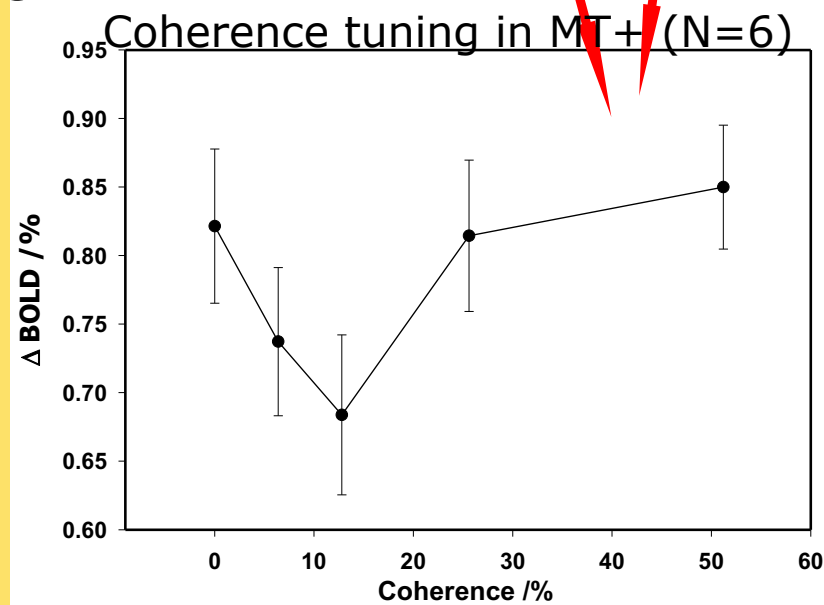

- Contrast in fMRI

*Hemodynamic Specificity*

- The Hemodynamic Transfer Function

*Location, Latency, Magnitude*

- **Best Results So Far**

*Temporal Resolution, Spatial Resolution*

- Neuronal Activation Input Strategies

*Block Design*

*Phase and Frequency Encoding*

*Orthogonal Designs*

*Parametric Designs*

*Event-Related Designs*

*Free Behavior Designs*

# Word stem completion

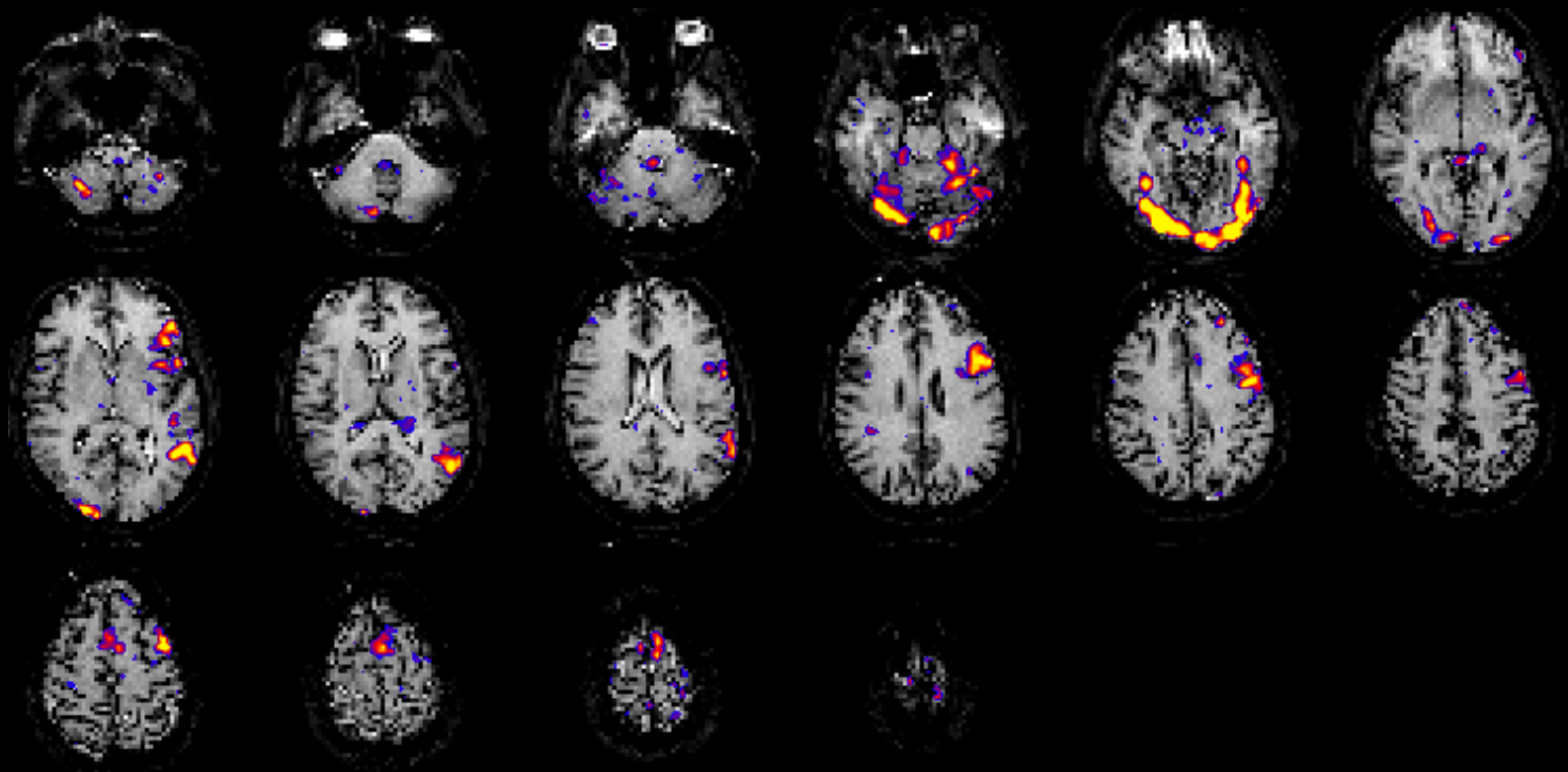

# Time Course Comparison Across Brain Regions

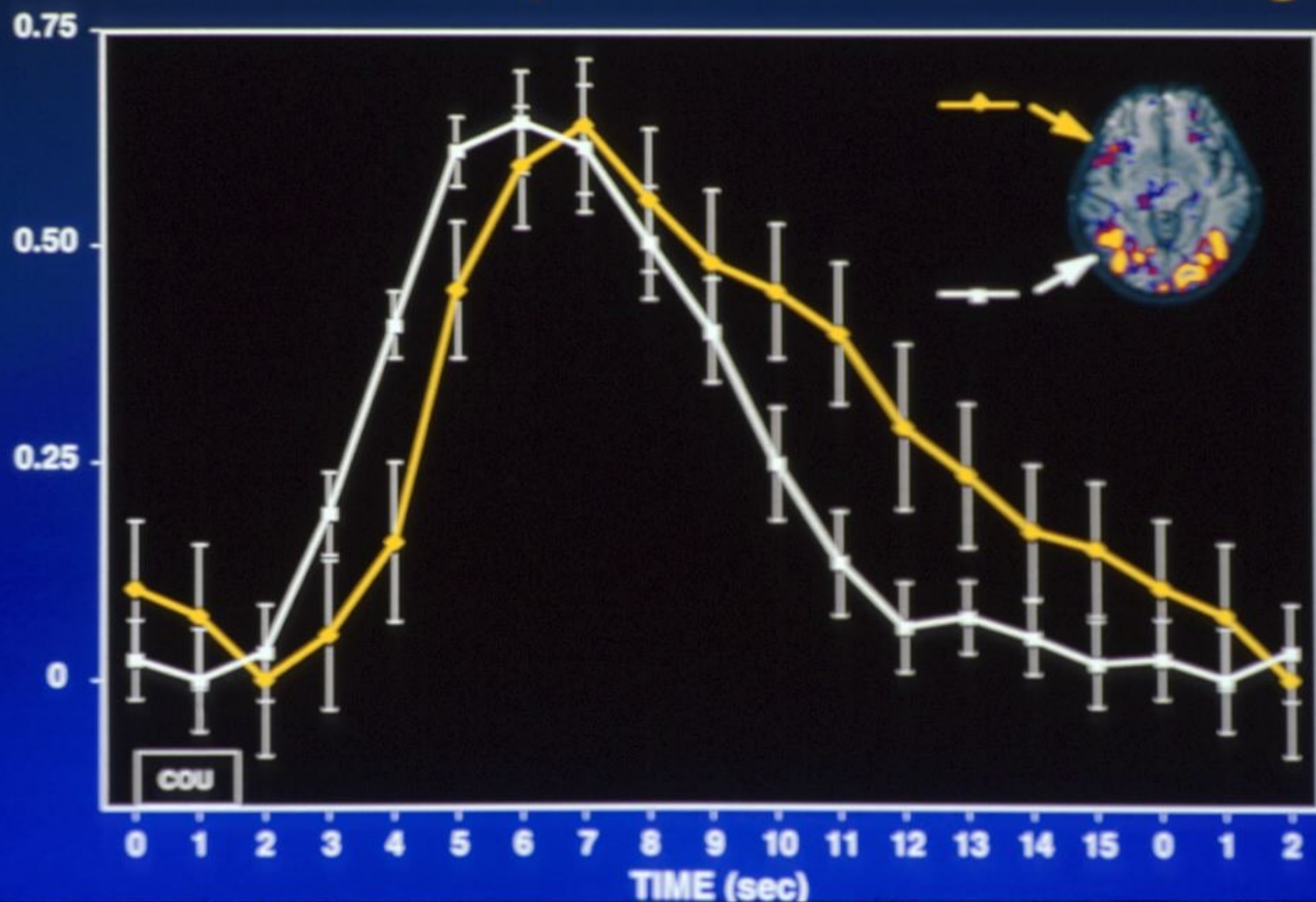



**Latency**

**Magnitude**

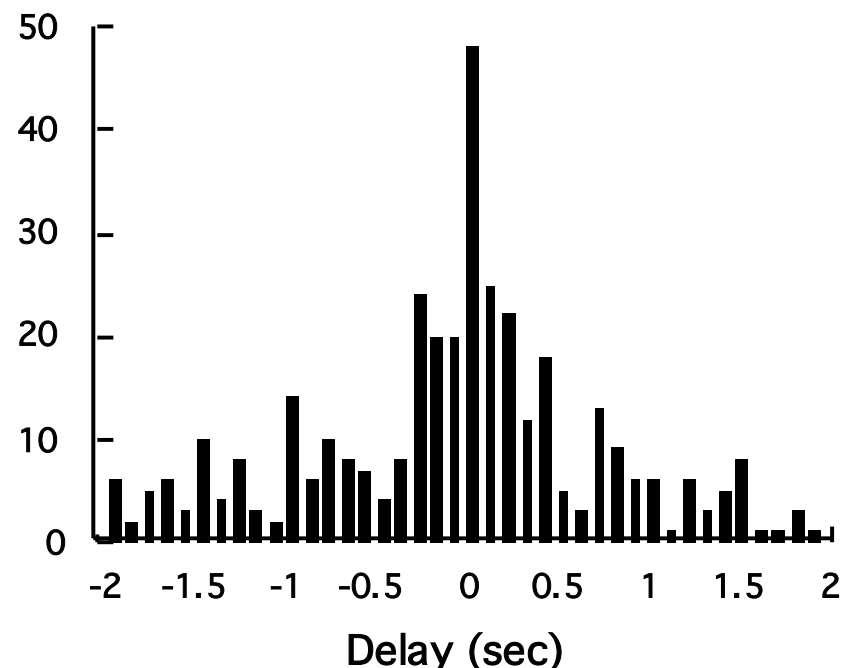
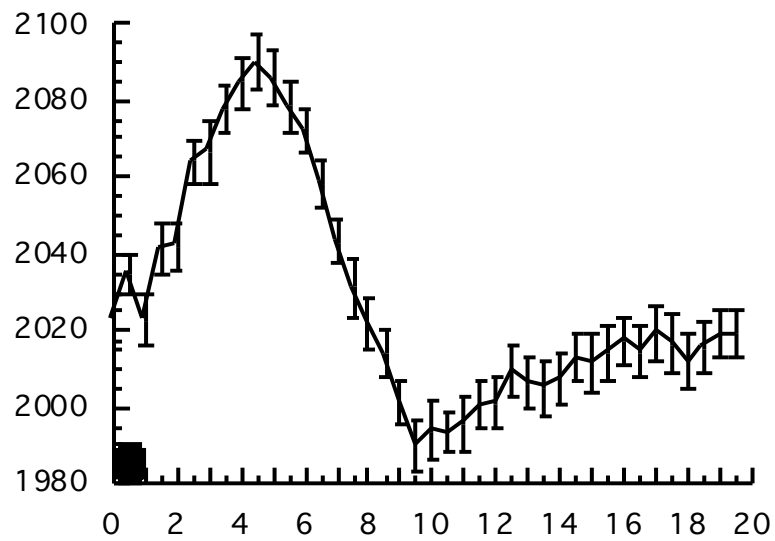
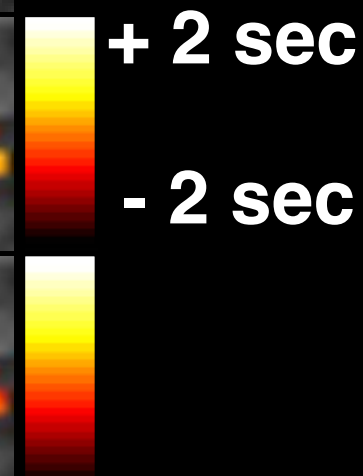
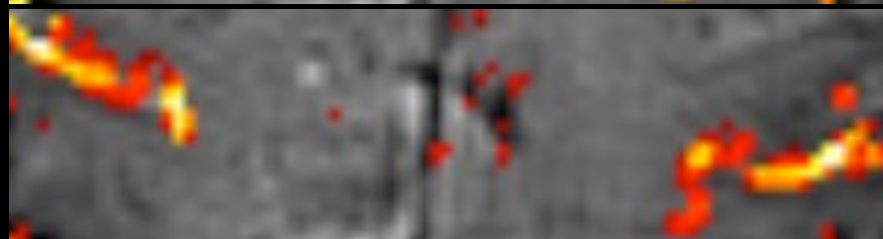
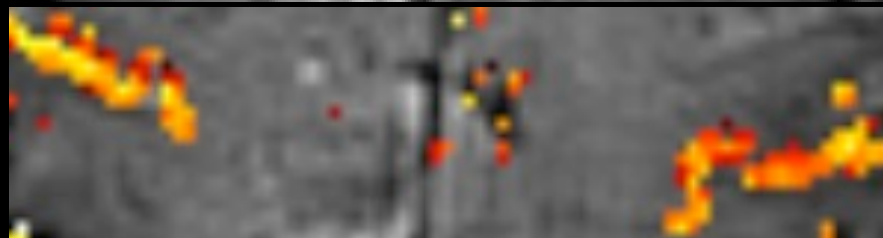

# Regions of Interest Used for Hemi-Field Experiment

**Right  
Hemisphere**

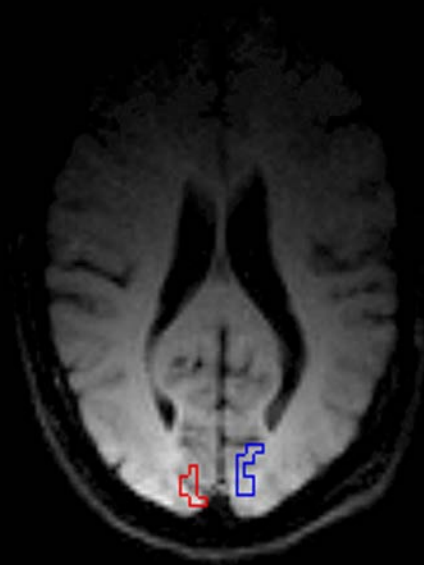

**Left  
Hemisphere**

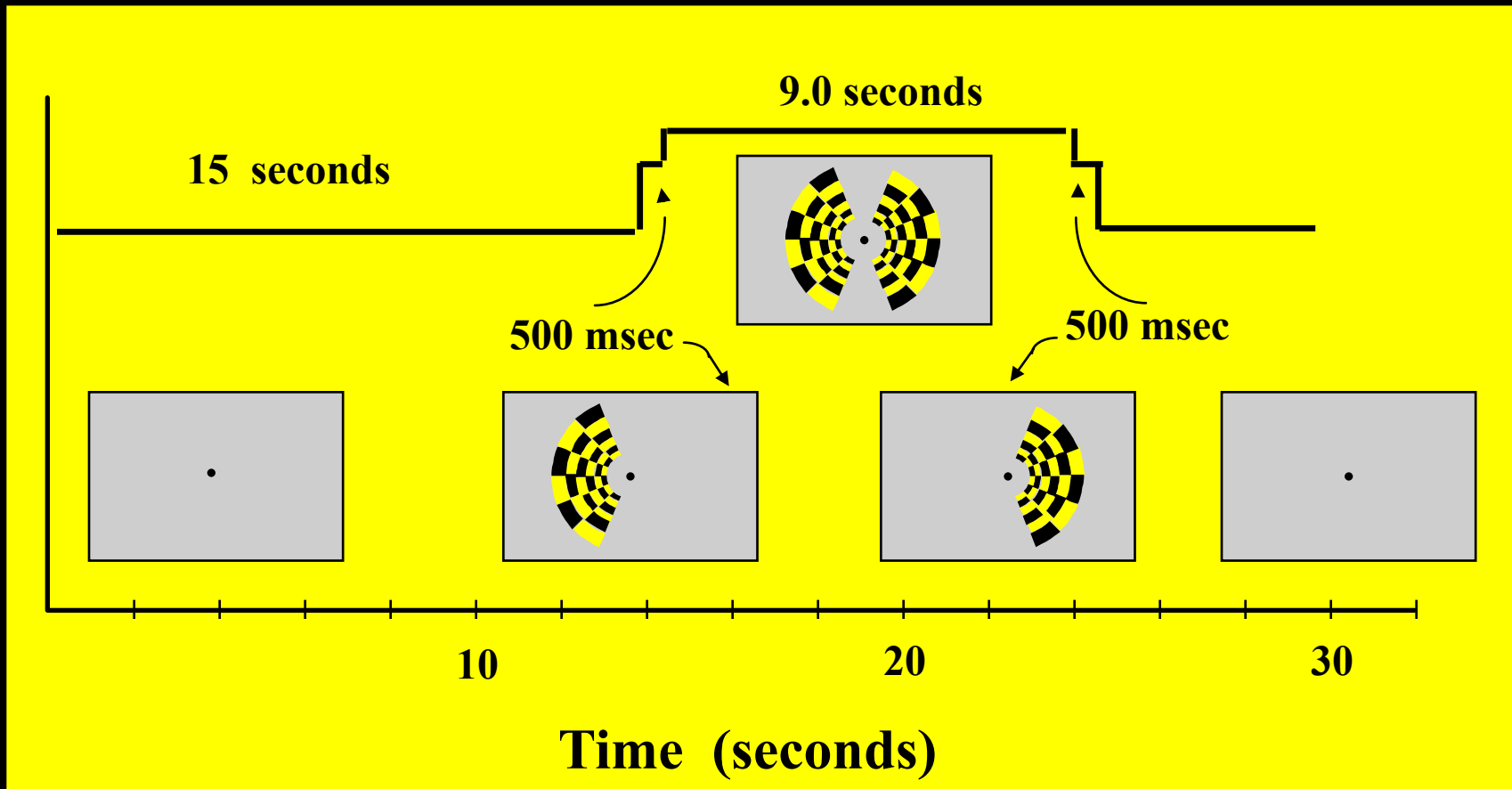

# Hemi-field with 500 msec asynchrony

Average of 6 runs    Standard Deviations Shown

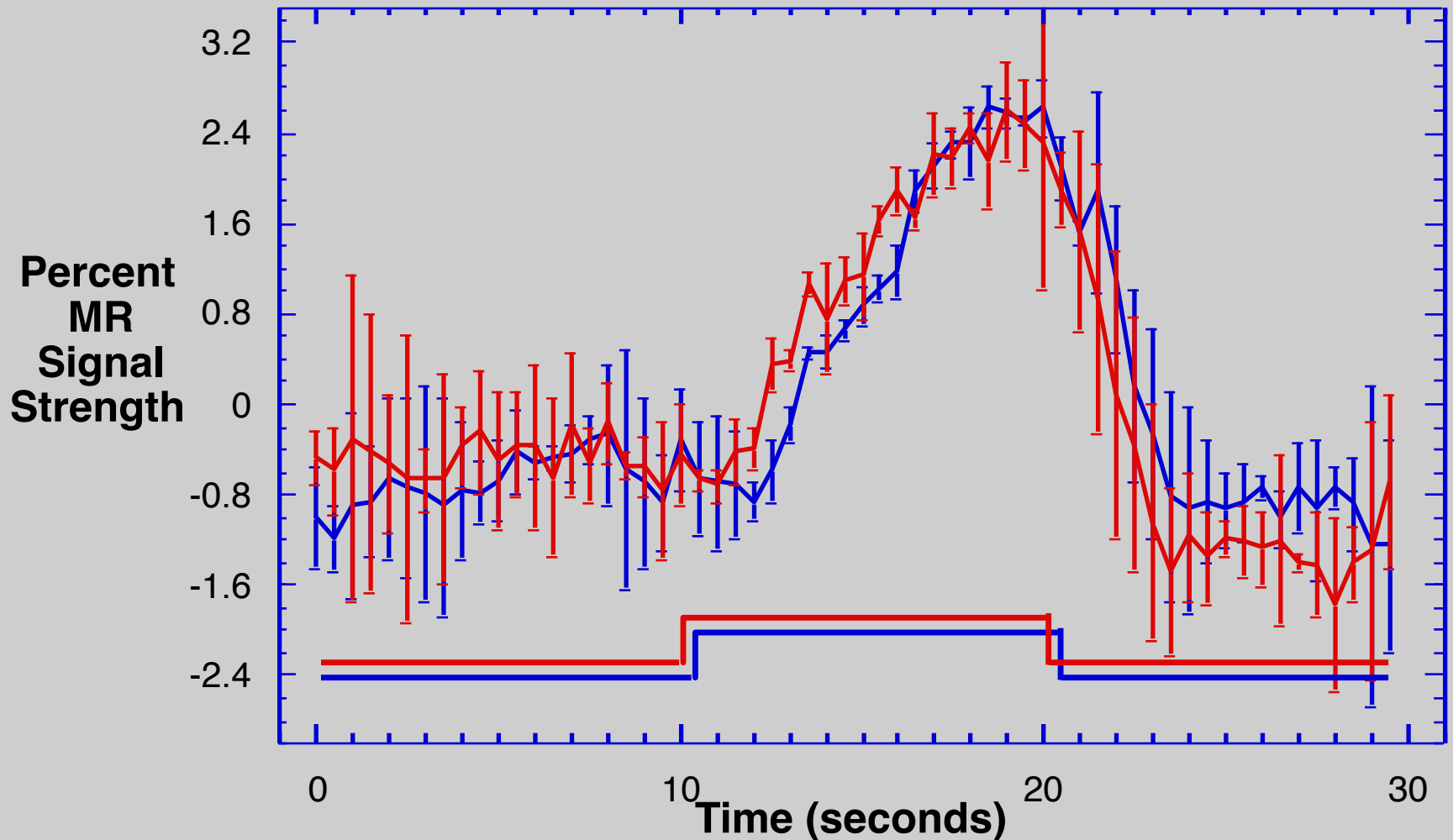

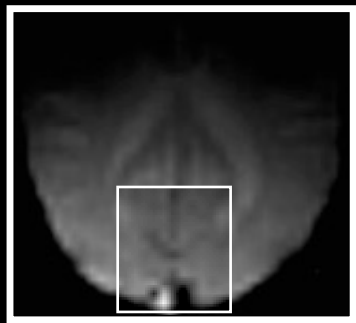

500 ms



500 ms



Right Hemifield

Left Hemifield

+ 2.5 s

0 s

- 2.5 s

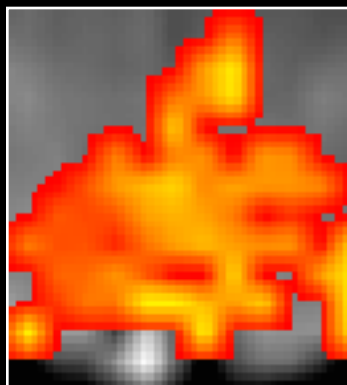

-

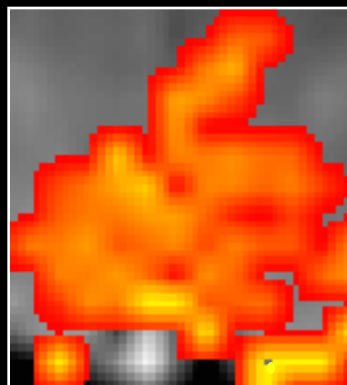

=

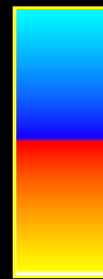
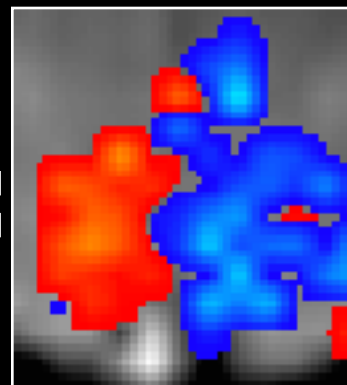

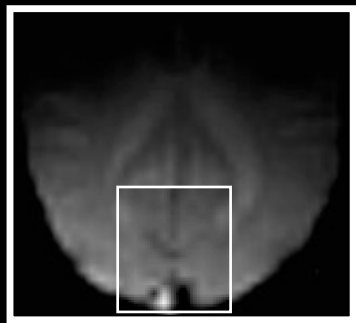

250 ms



250 ms



Right Hemifield

Left Hemifield

+ 2.5 s

0 s

- 2.5 s

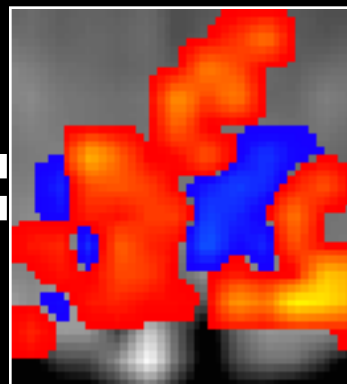
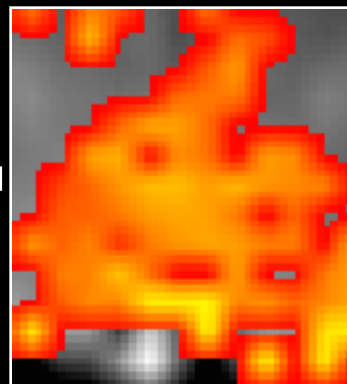
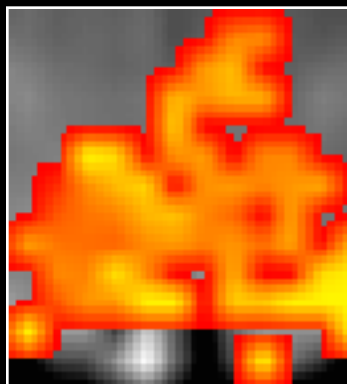

# Single Shot Imaging

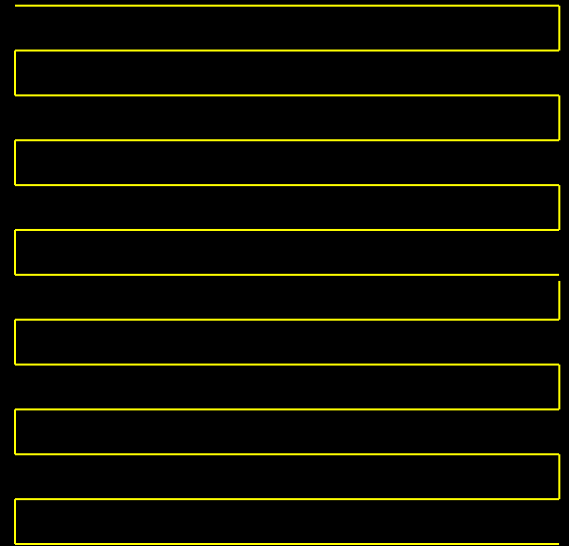
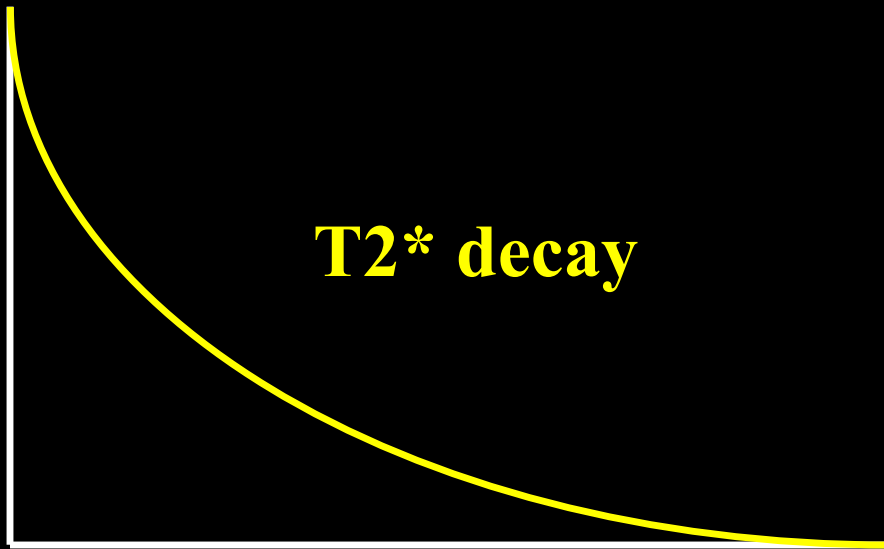

**EPI Readout Window**

**$\approx 20$  to  $40$  ms**

# Multishot Imaging



**EPI Window 1**

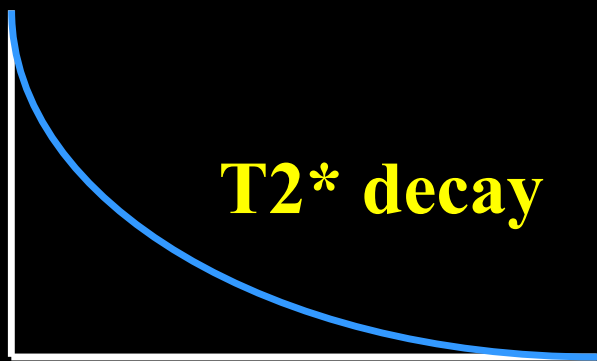

**EPI Window 2**

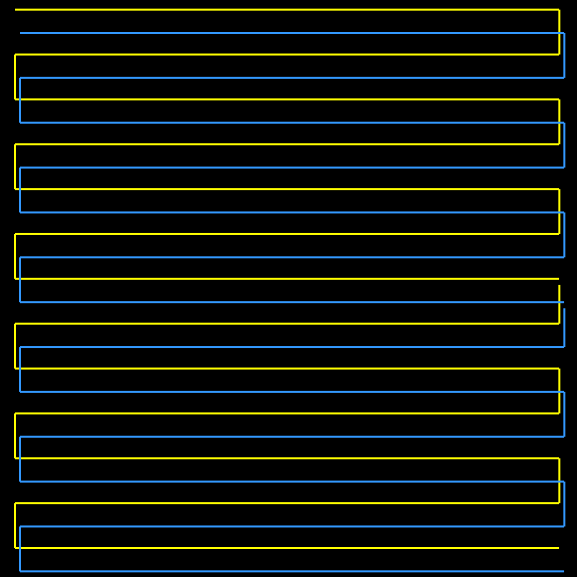



# Multi Shot EPI

Excitations  
Matrix Size

1

64 x 64

2

128 x 128

4

256 x 128

8

256

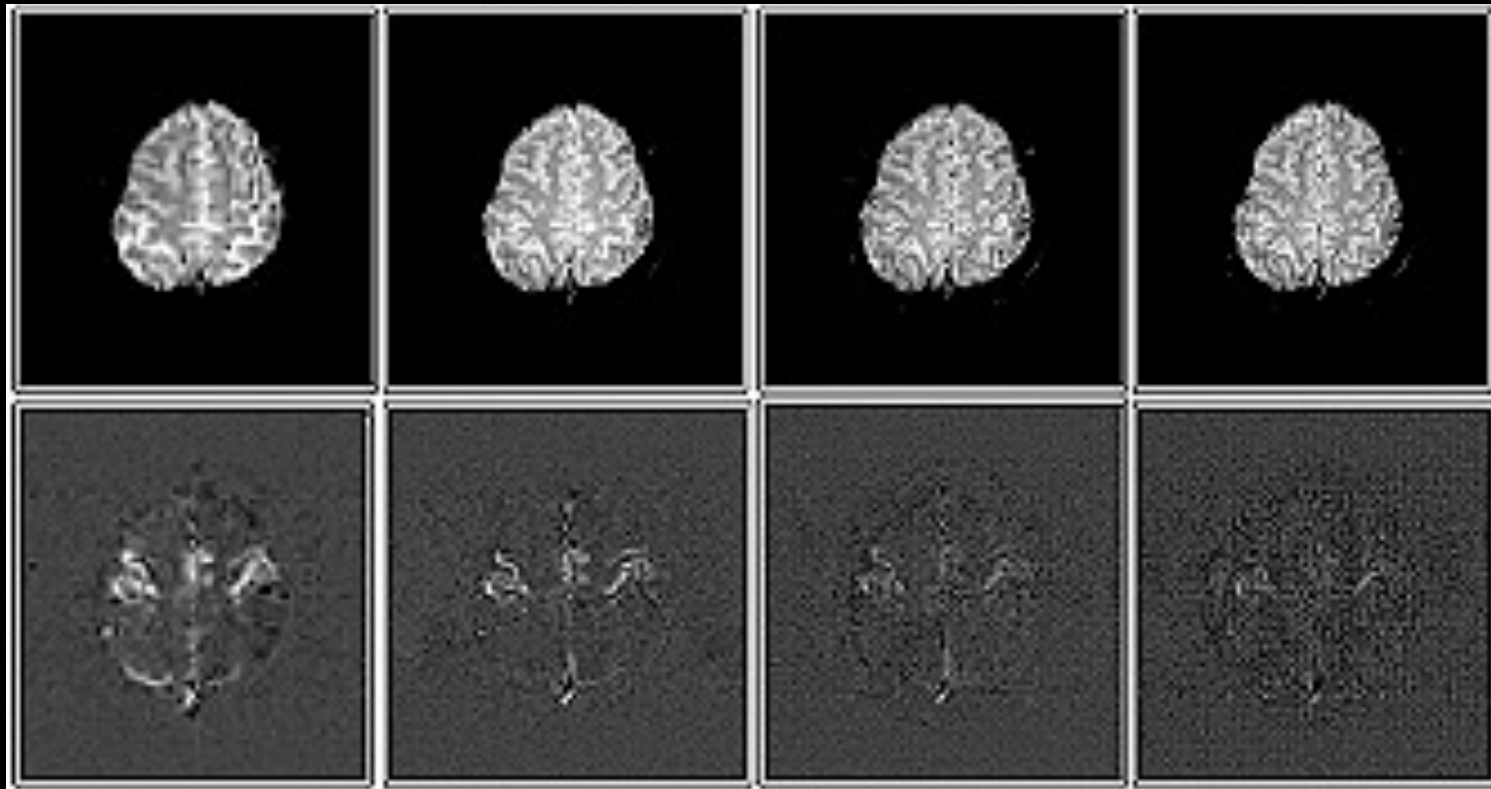

# Partial k-space imaging

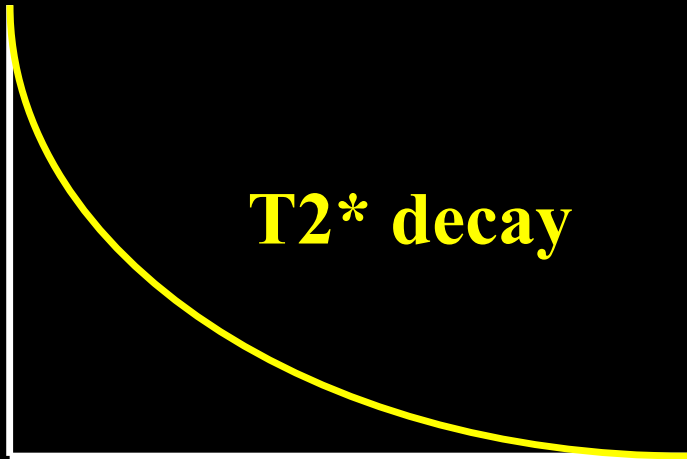

**EPI Window**

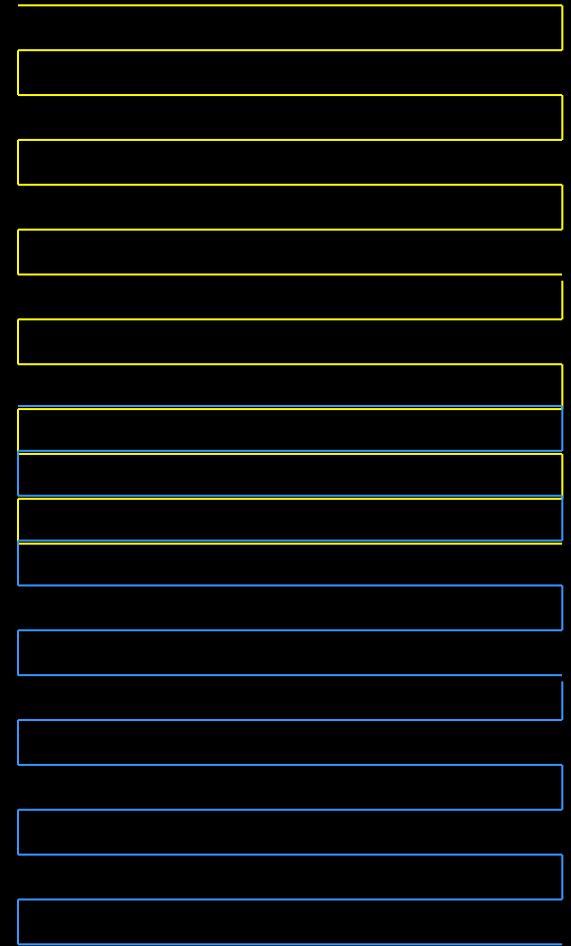

**Single - Shot EPI at 3T:  
Half NEX, 256 x 256, 16 cm FOV**

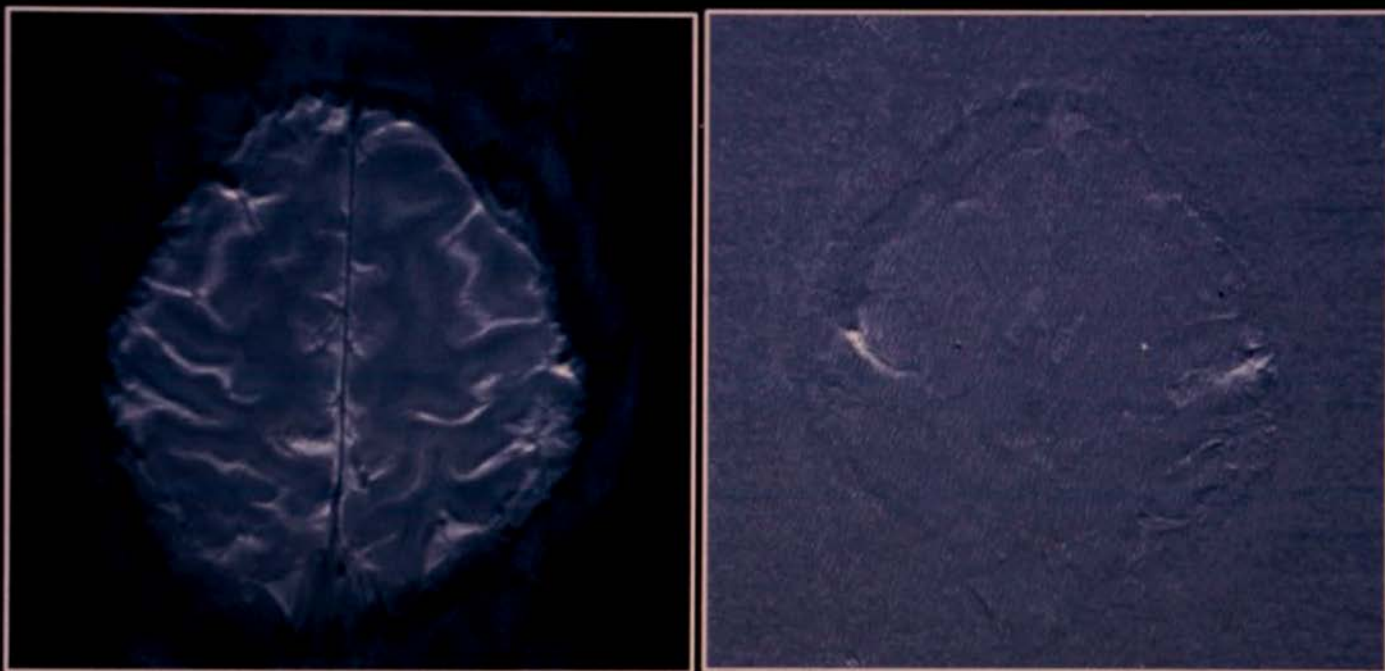

## Fractional Signal Change

2.5 mm<sup>2</sup>

1.25 mm<sup>2</sup>

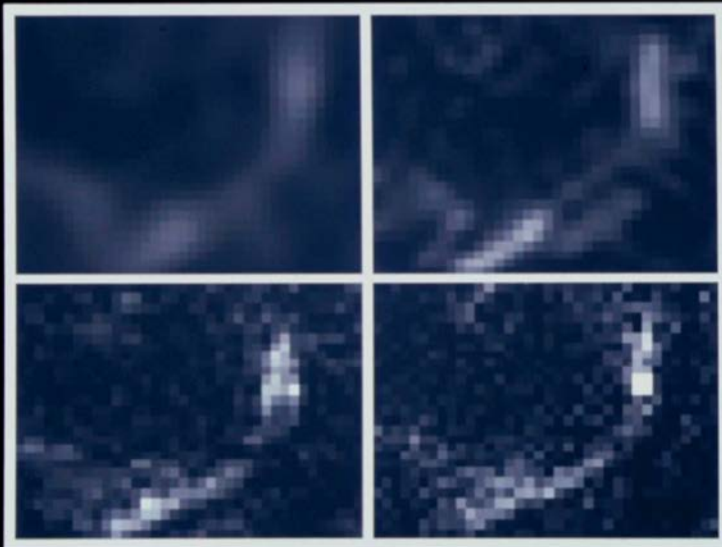

0.83 mm<sup>2</sup>

0.62 mm<sup>2</sup>

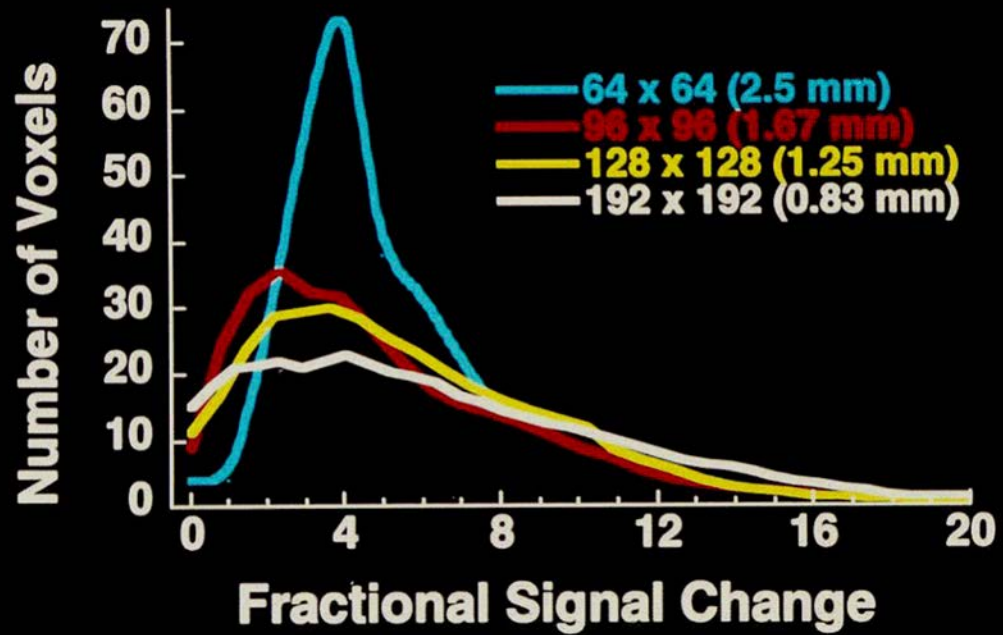

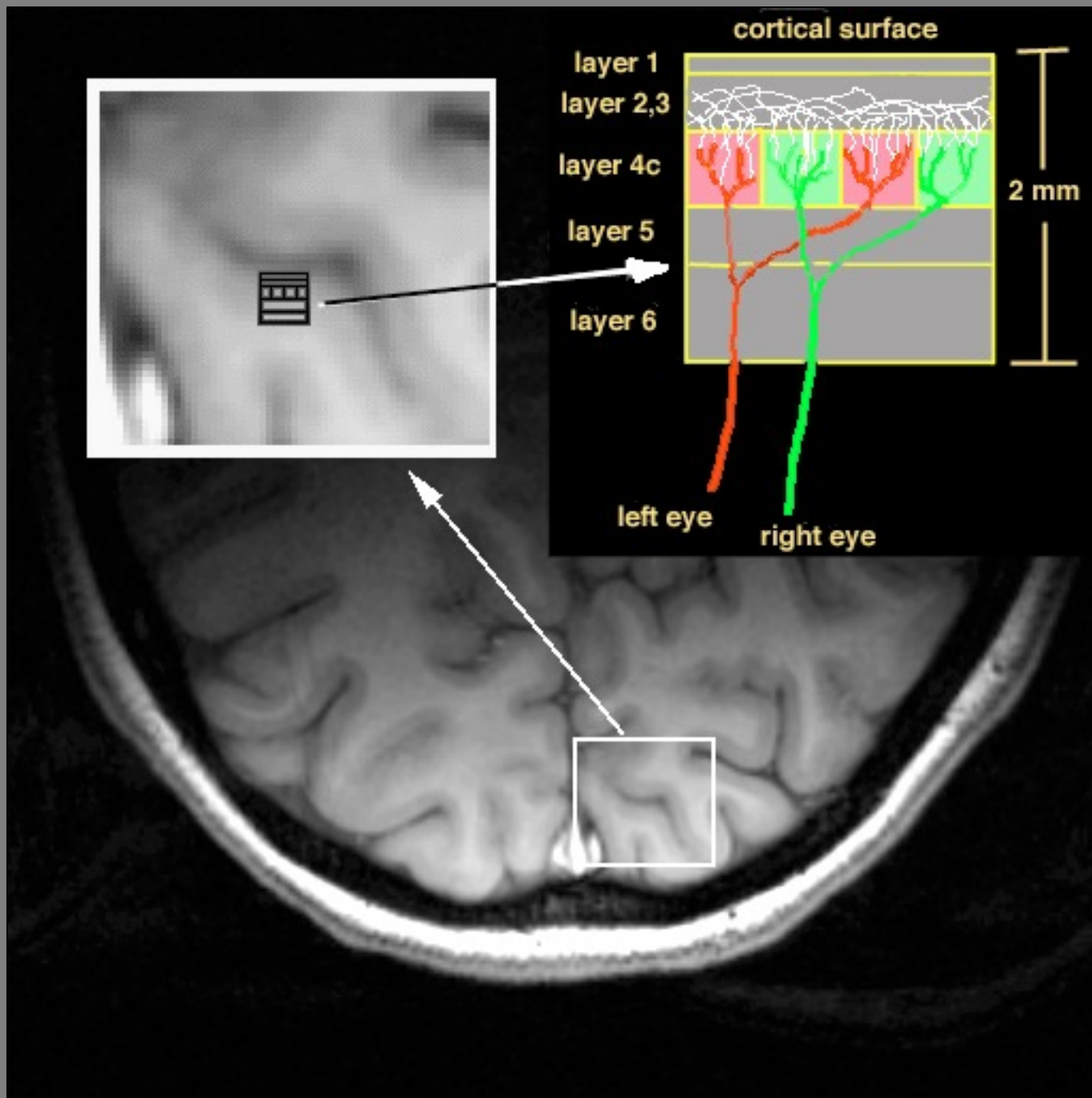

# ODC Maps using fMRI

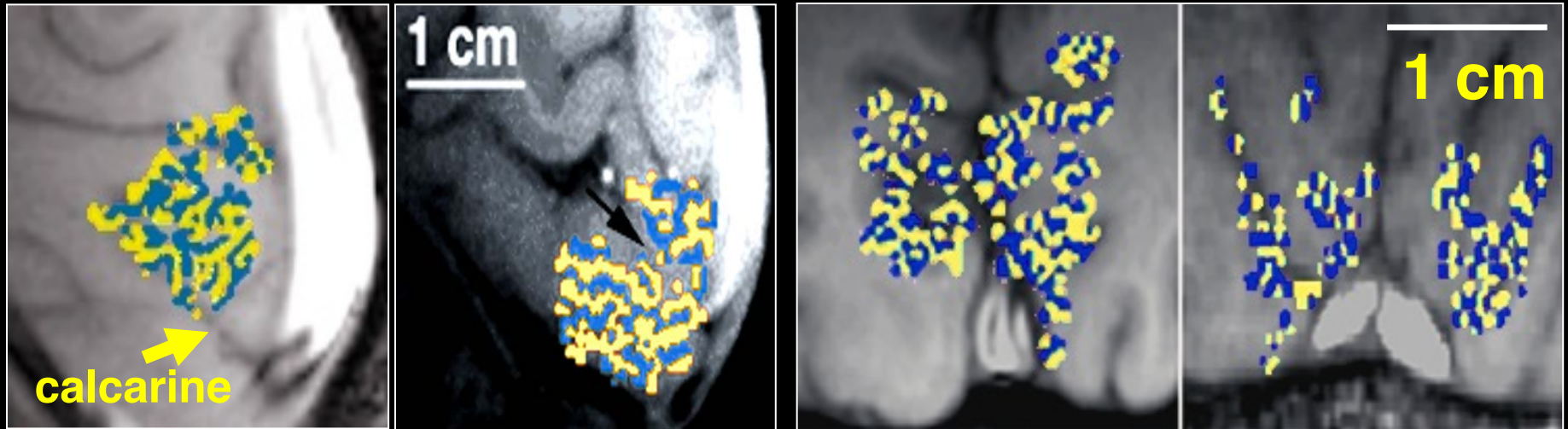

- Identical in size, orientation, and appearance to those obtained by optical imaging<sup>1</sup> and histology<sup>3,4</sup>.

<sup>1</sup>Malonek D, Grinvald A. *Science* 272, 551-4 (1996).

<sup>3</sup>Horton JC, Hocking DR. *J Neurosci* 16, 7228-39 (1996).

<sup>4</sup>Horton JC, et al. *Arch Ophthalmol* 108, 1025-31 (1990).

# Why short is better than long

The vascular response to prolonged neural stimulation

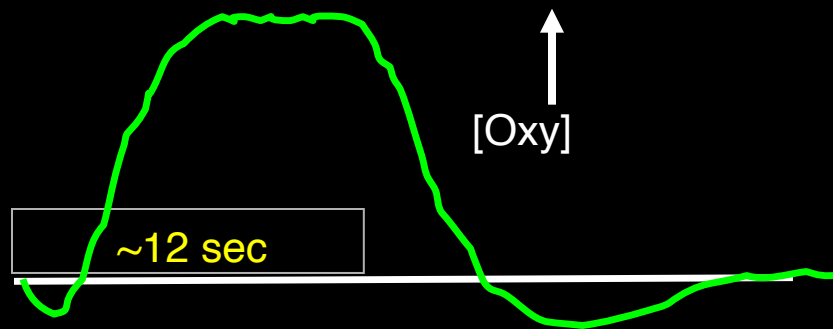

It is argued that fMRI cannot achieve submillimeter functional resolution because a saturated hyperoxic vascular response to neural activity spreads over many millimeters<sup>1,2</sup>.

However, optical imaging has demonstrated that the hyperoxic response can yield well-localized maps when using short duration stimuli (<5 sec)<sup>1</sup>.

The vascular response to brief neural stimulation

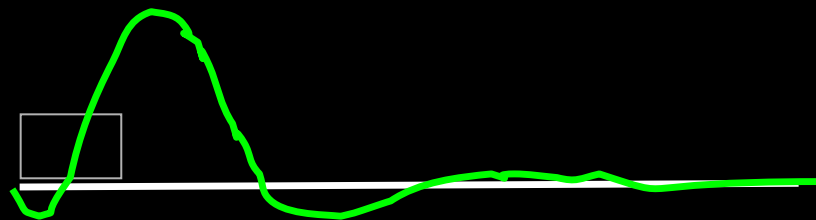

<sup>1</sup>Malonek D, Grinvald A. Science 272, 551-4 (1996).

<sup>2</sup>Kim D-S, Duong T, Kim S-G. Nat Neurosci 3, 164-9 (2000).

# Temporal S/N vs. Image S/N

## PHANTOMS

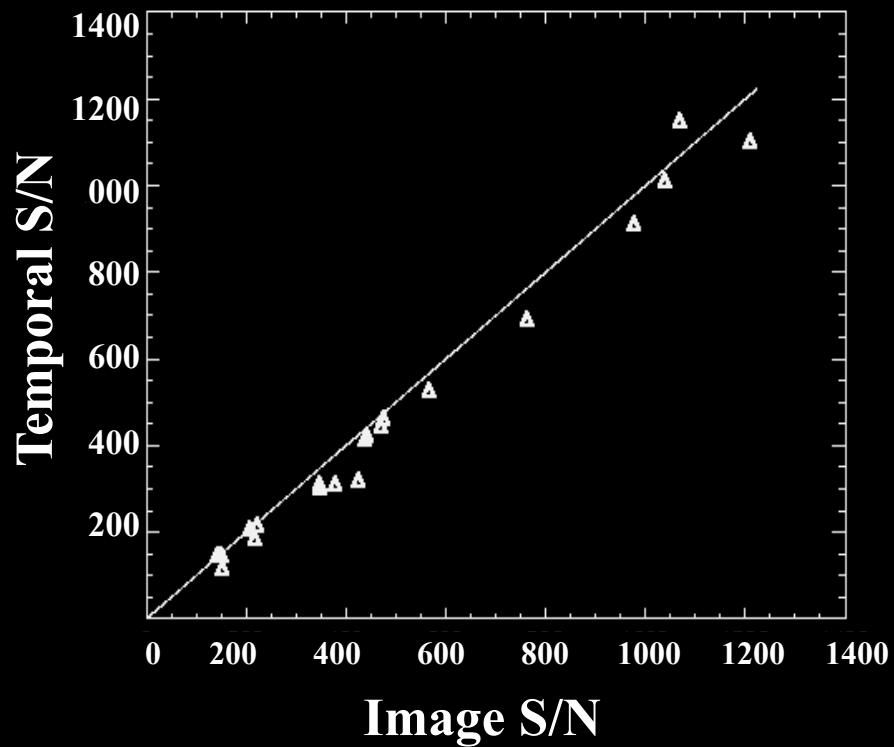

## SUBJECTS

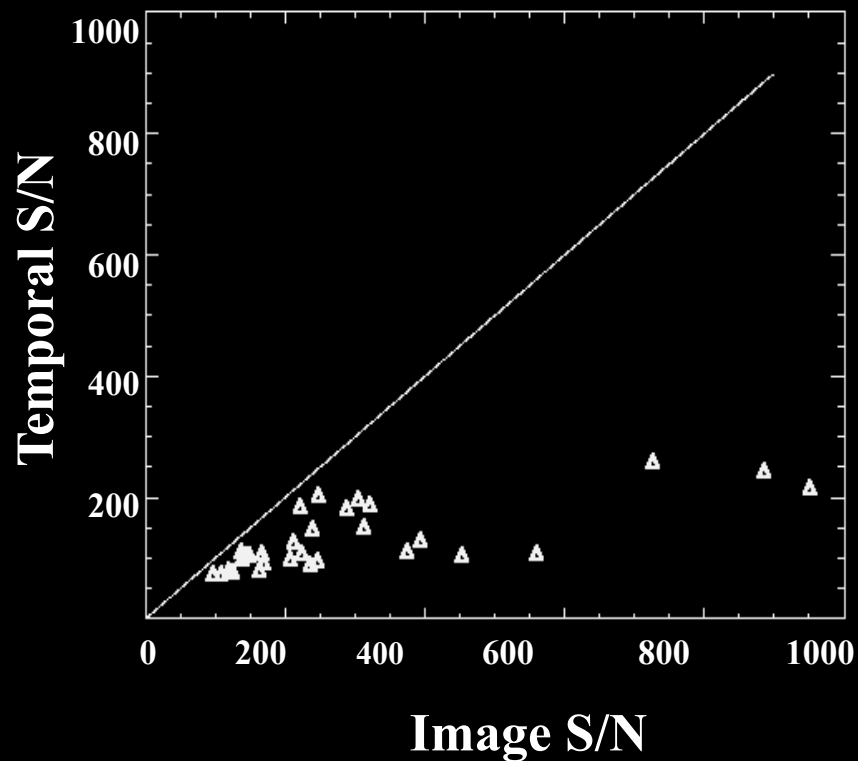



# Temporal vs. Image S/N Optimal Resolution Study

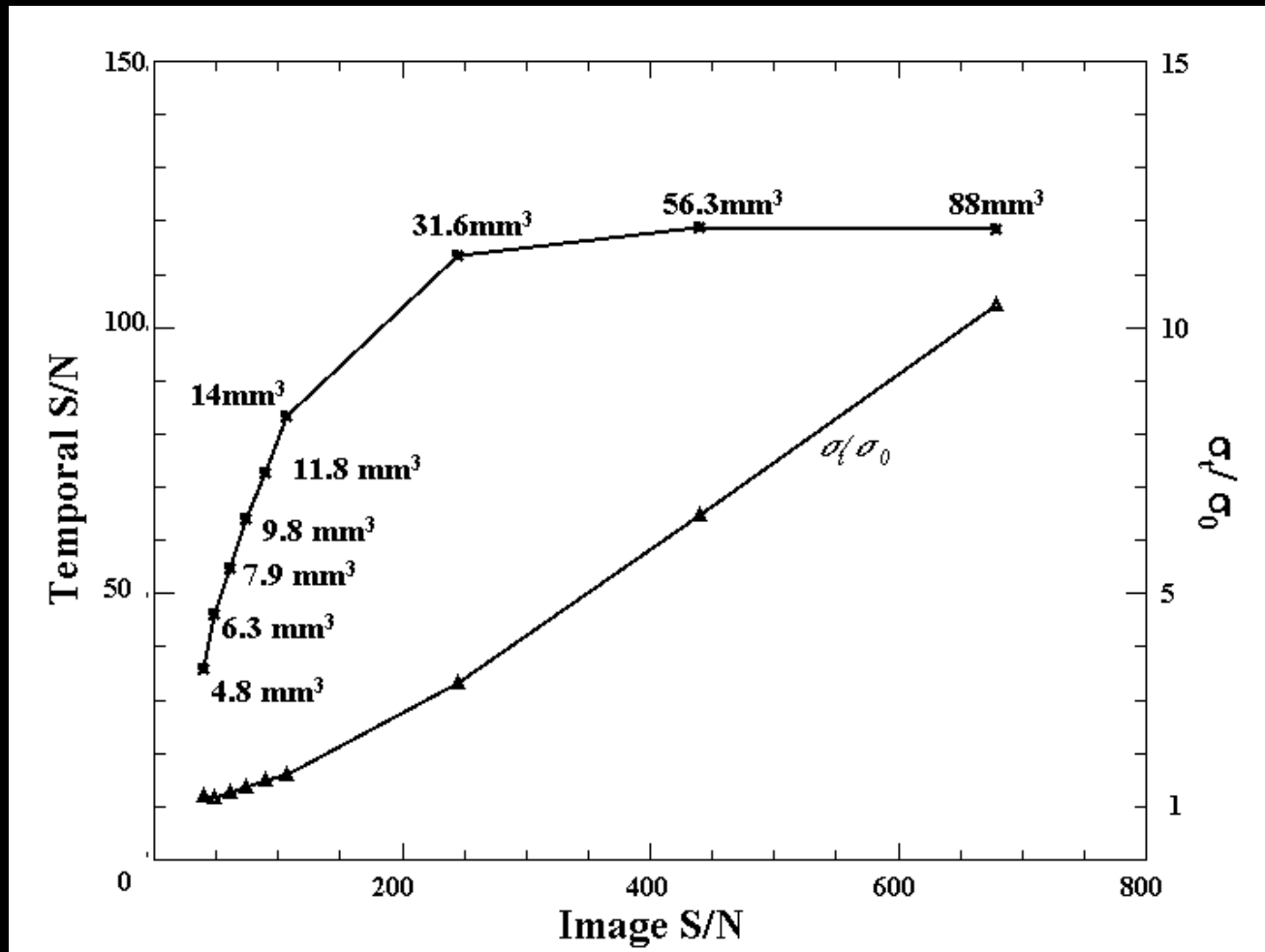

Human data

Petridou et al

# Temporal vs. Image S/N Optimal Resolution Study

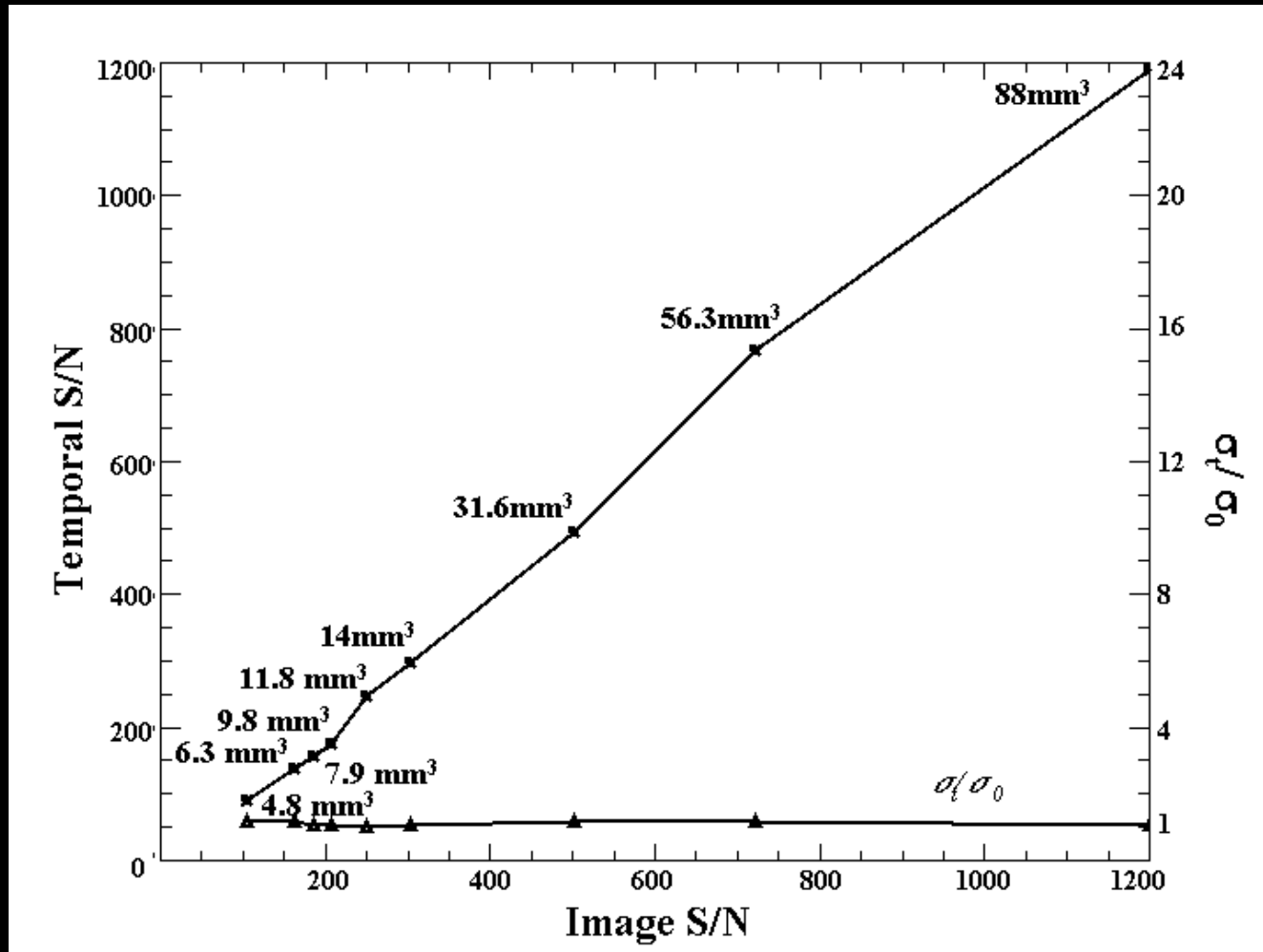

Phantom data

- Contrast in fMRI

*Hemodynamic Specificity*

- The Hemodynamic Transfer Function

*Location, Latency, Magnitude*

- Best Results So Far

*Temporal Resolution, Spatial Resolution*

- **Neuronal Activation Input Strategies**

*Block Design*

*Phase and Frequency Encoding*

*Orthogonal Designs*

*Parametric Designs*

*Event-Related Designs*

*Free Behavior Designs*

# Neuronal Activation Input Strategies

1. Block Design

2. Frequency Encoding

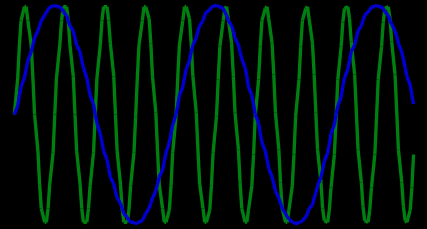

3. Phase Encoding

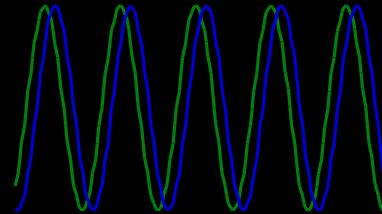

4. Single Event

5. Orthogonal Block Design

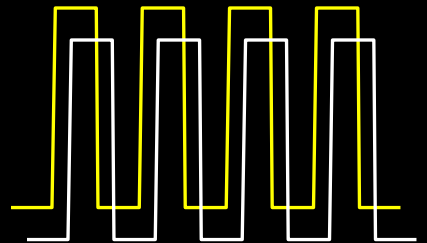

6. Free Behavior Design.

# Neuronal Activation Input Strategies

## 1. Block Design

## 2. Frequency Encoding

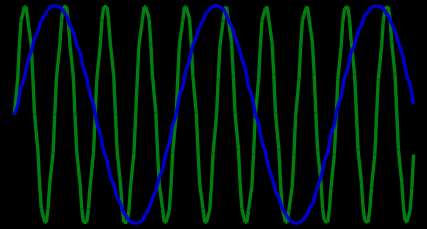

## 3. Phase Encoding

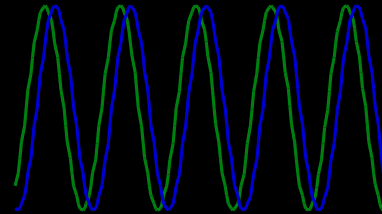

## 4. Single Event

## 5. Orthogonal Block Design

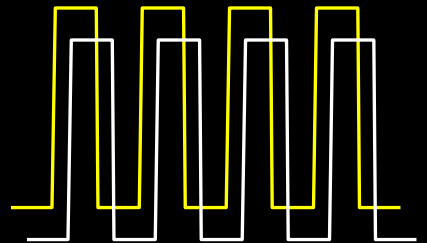

## 6. Free Behavior Design.

## Both the Task and Presentation Rate Affect the fMRI Response

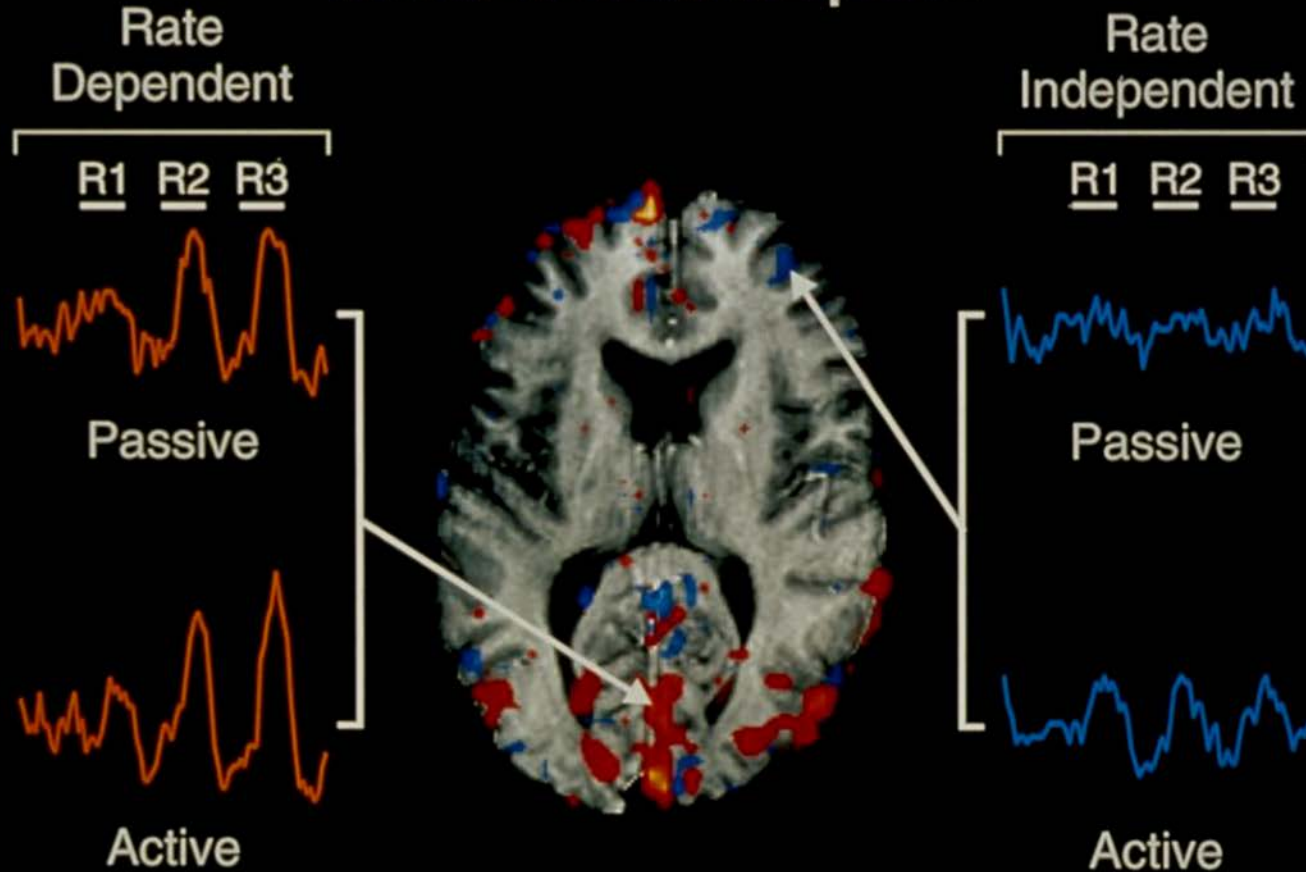

DeYoe et al.

# Neuronal Activation Input Strategies

1. Block Design

2. Frequency Encoding

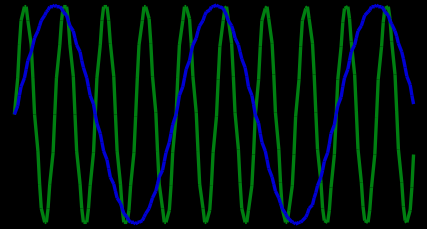

3. Phase Encoding

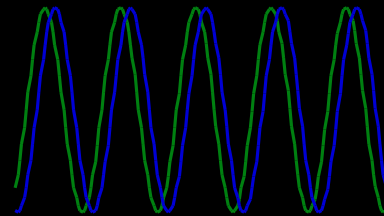

4. Single Event

5. Orthogonal Block Design

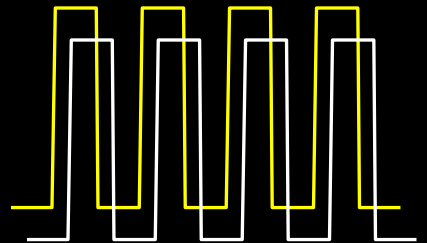

6. Free Behavior Design.

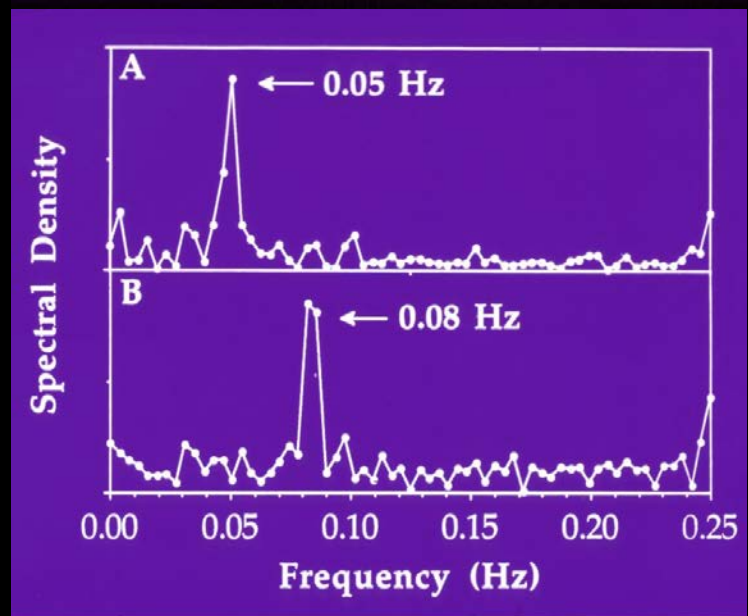
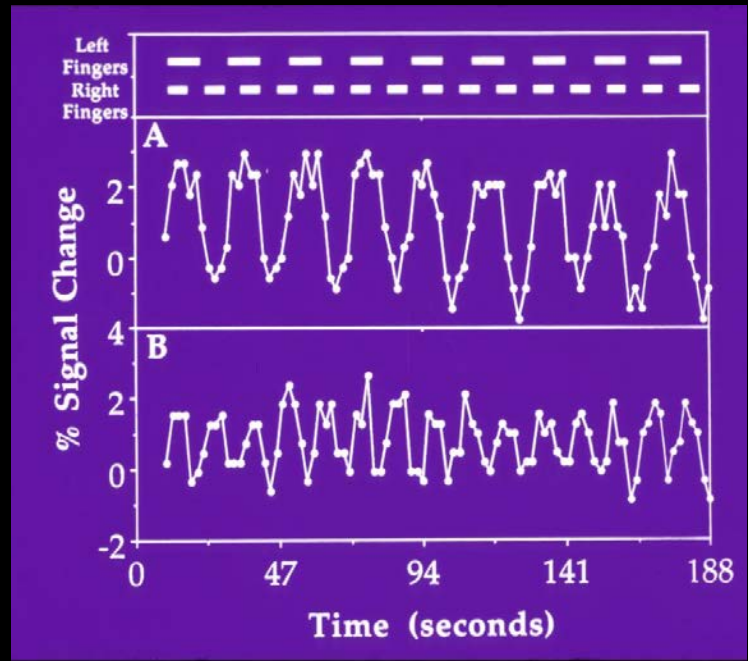
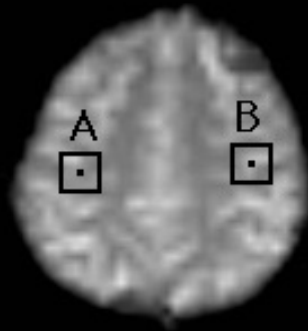



**0.08 Hz**

**0.05 Hz**

**spectral  
density**

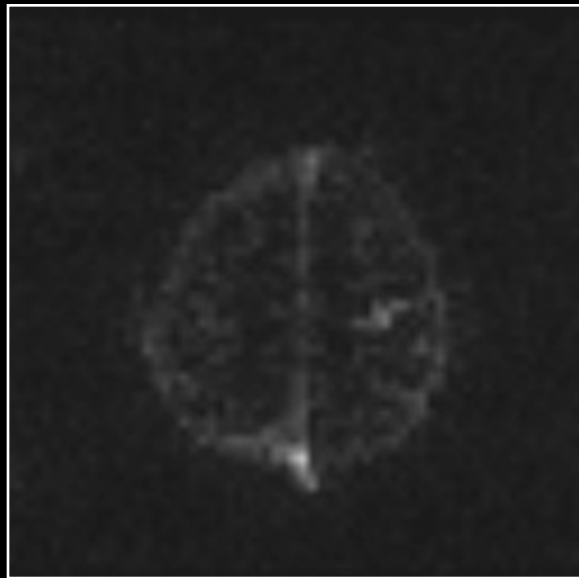

**c.c. > 0.5  
with spectra**

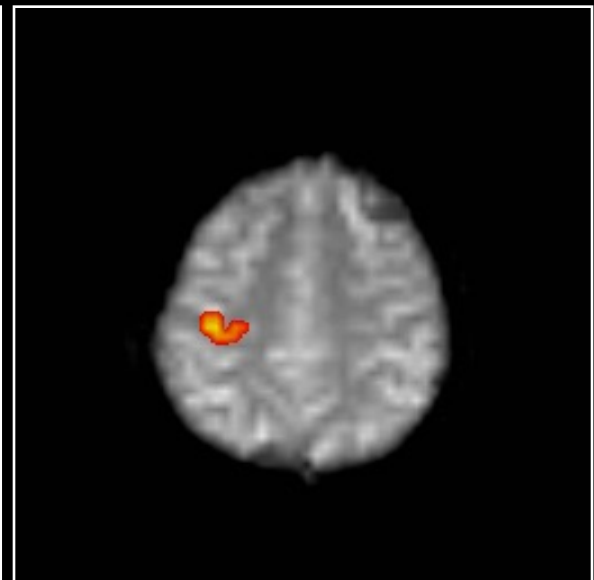
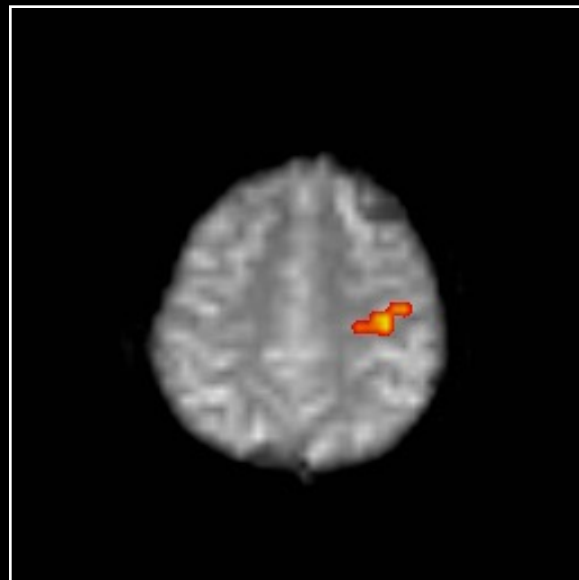

# Neuronal Activation Input Strategies

1. Block Design

2. Frequency Encoding

3. Phase Encoding

4. Single Event

5. Orthogonal Block Design

6. Free Behavior Design.

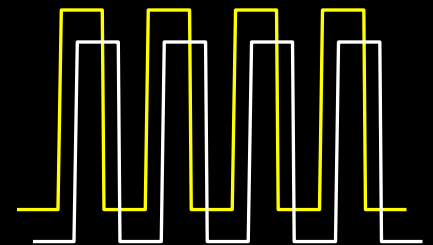
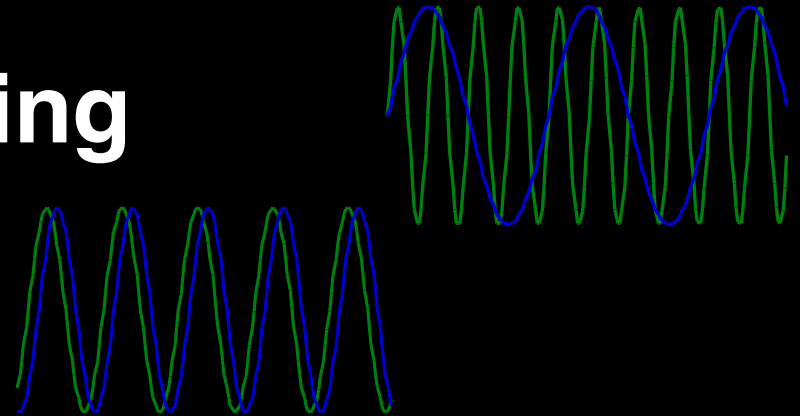

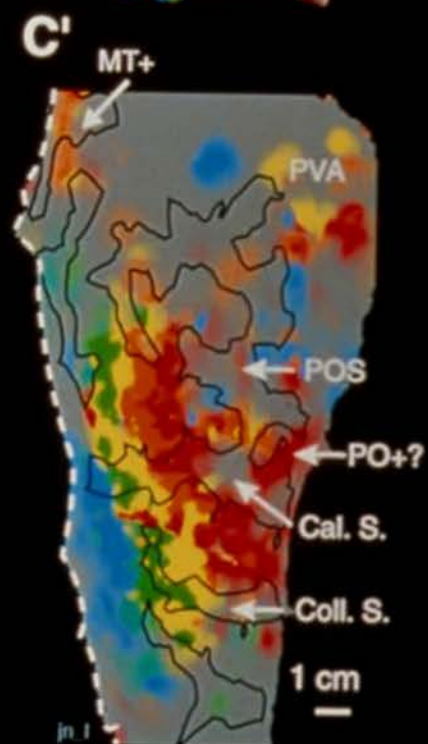
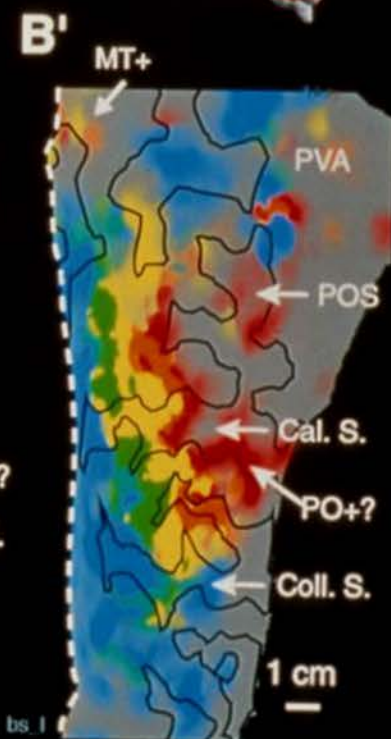
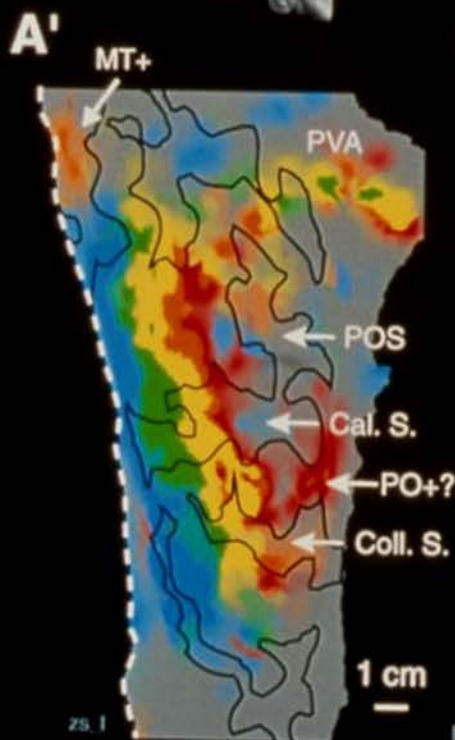
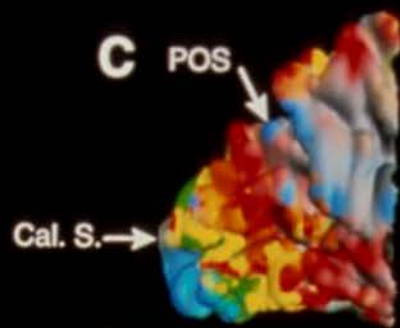
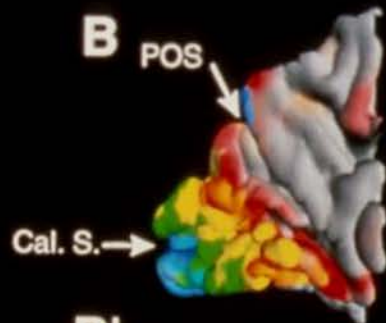
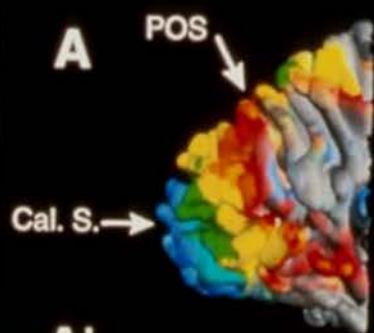

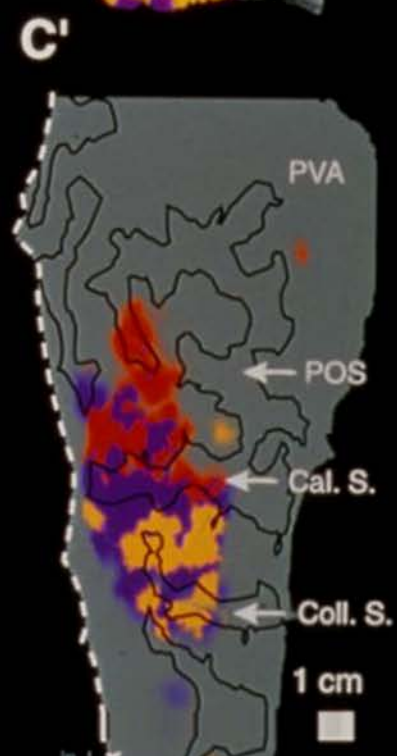
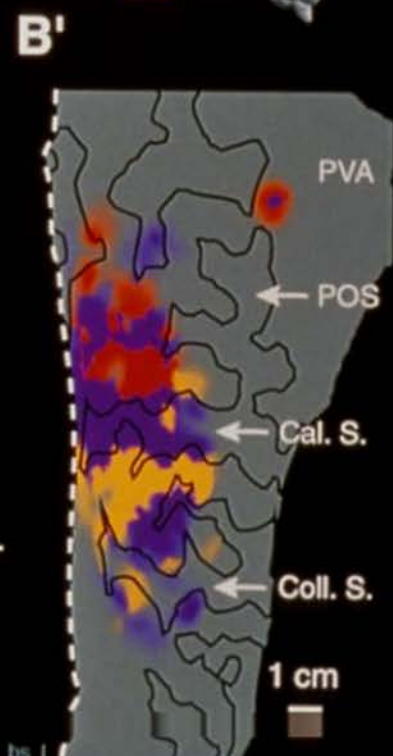
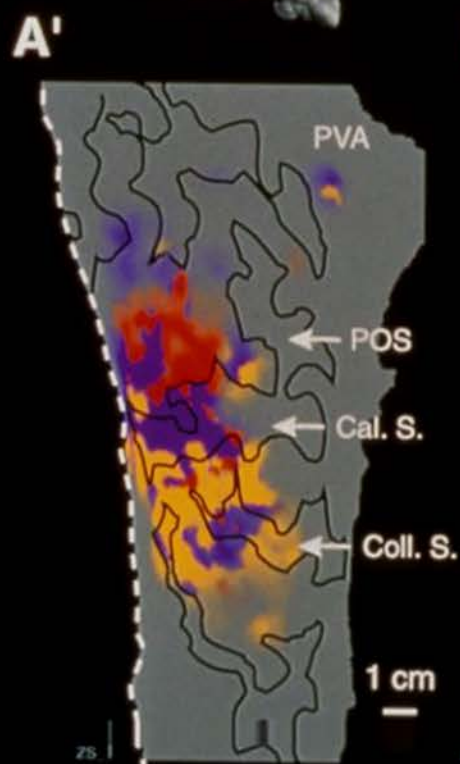
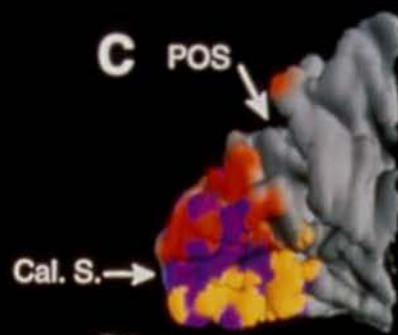
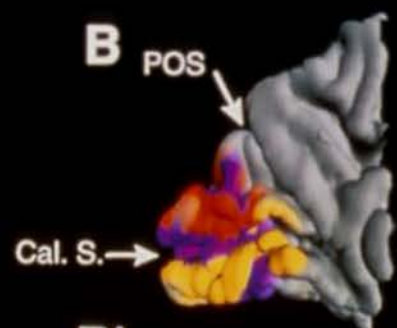
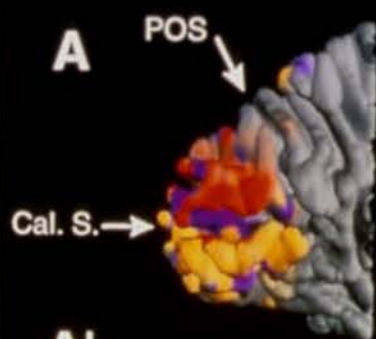

# Neuronal Activation Input Strategies

1. Block Design

2. Frequency Encoding

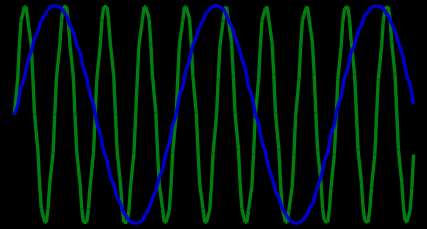

3. Phase Encoding

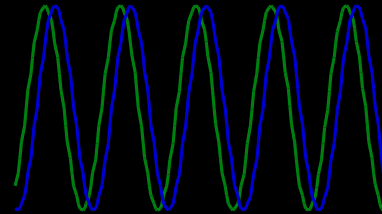

4. Single Event

5. Orthogonal Block Design

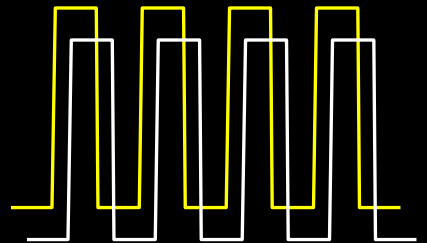

6. Free Behavior Design.

# Detectability – constant ISI

SD – stimulus duration

ISI – inter-stimulus interval

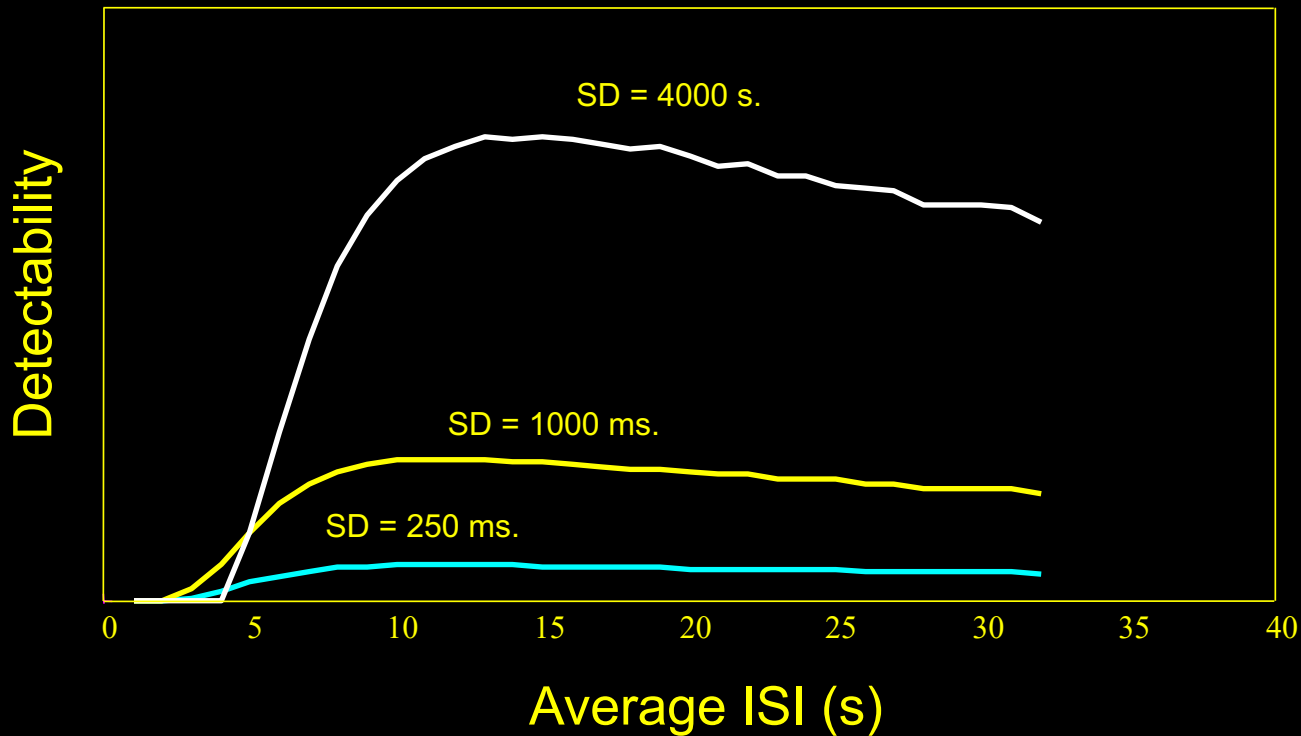
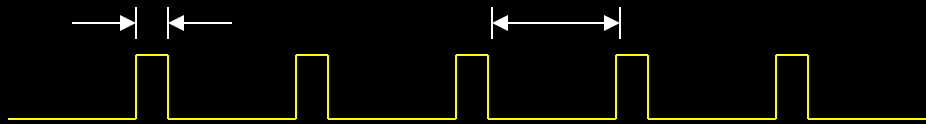

# Visual Activation Paradigm: 1 , 2, & 3 Trials

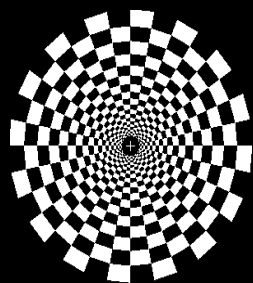

**0 sec**

**20 sec**

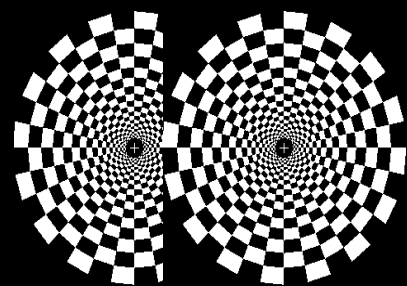

**0 sec 2 sec**

**20 sec**

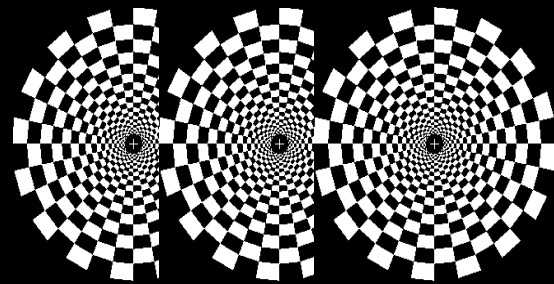

**0 sec 2 sec 4 sec**

**20 sec**

# Response to Multiple Trials: Subject RW

## RAW DATA

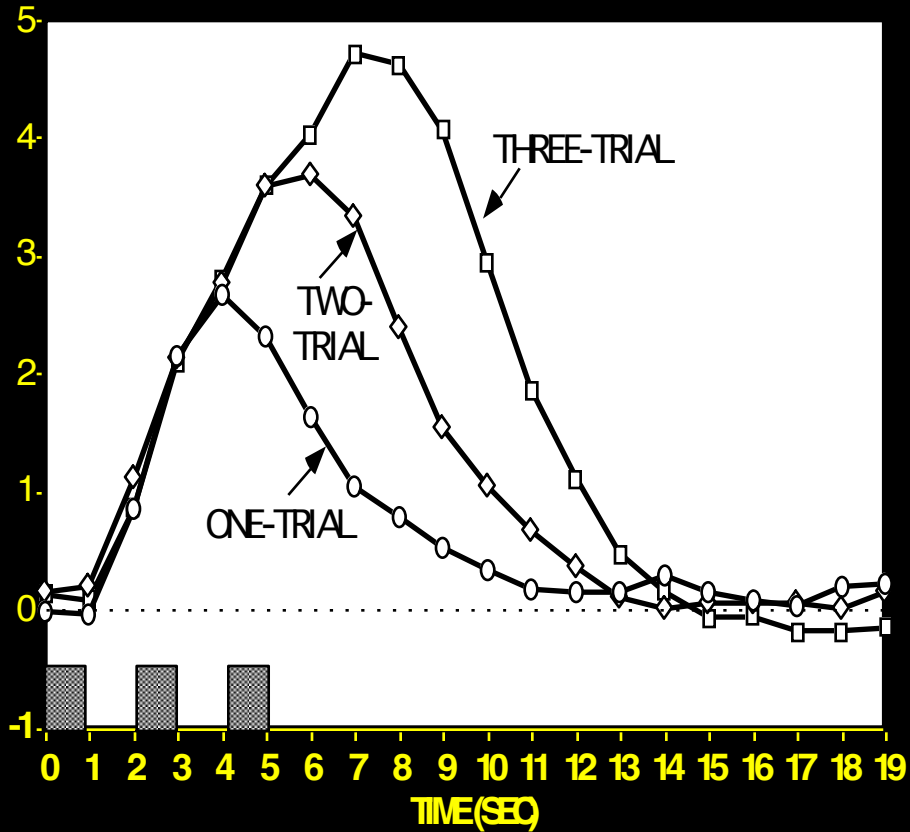

## ESTIMATED RESPONSES

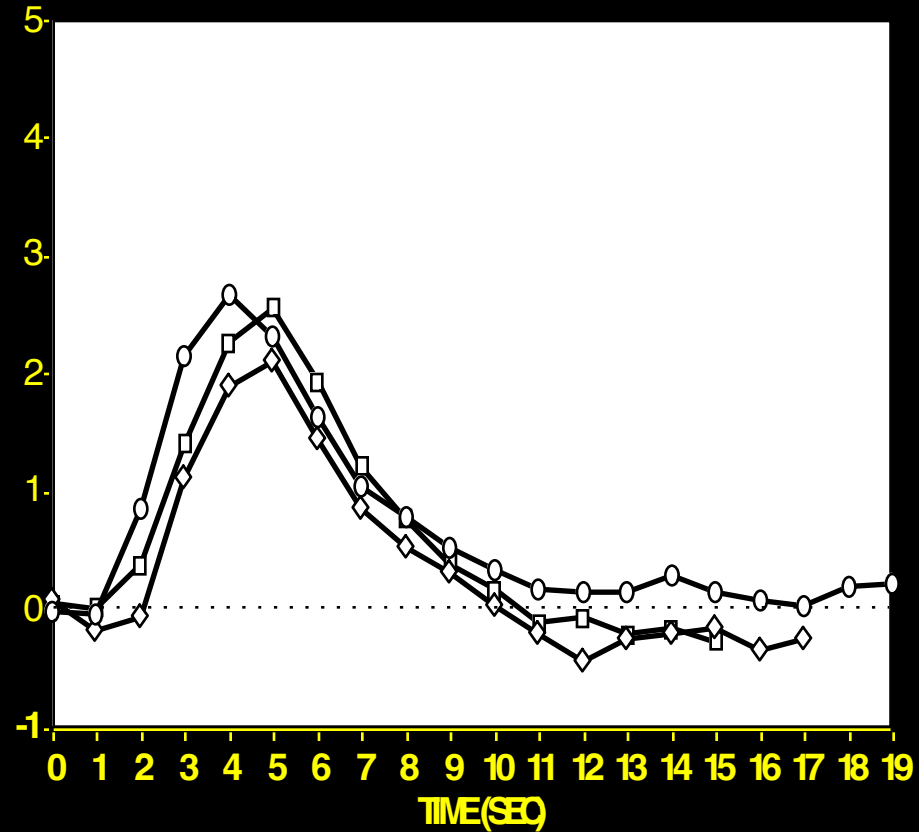



# Detectability vs. Average ISI

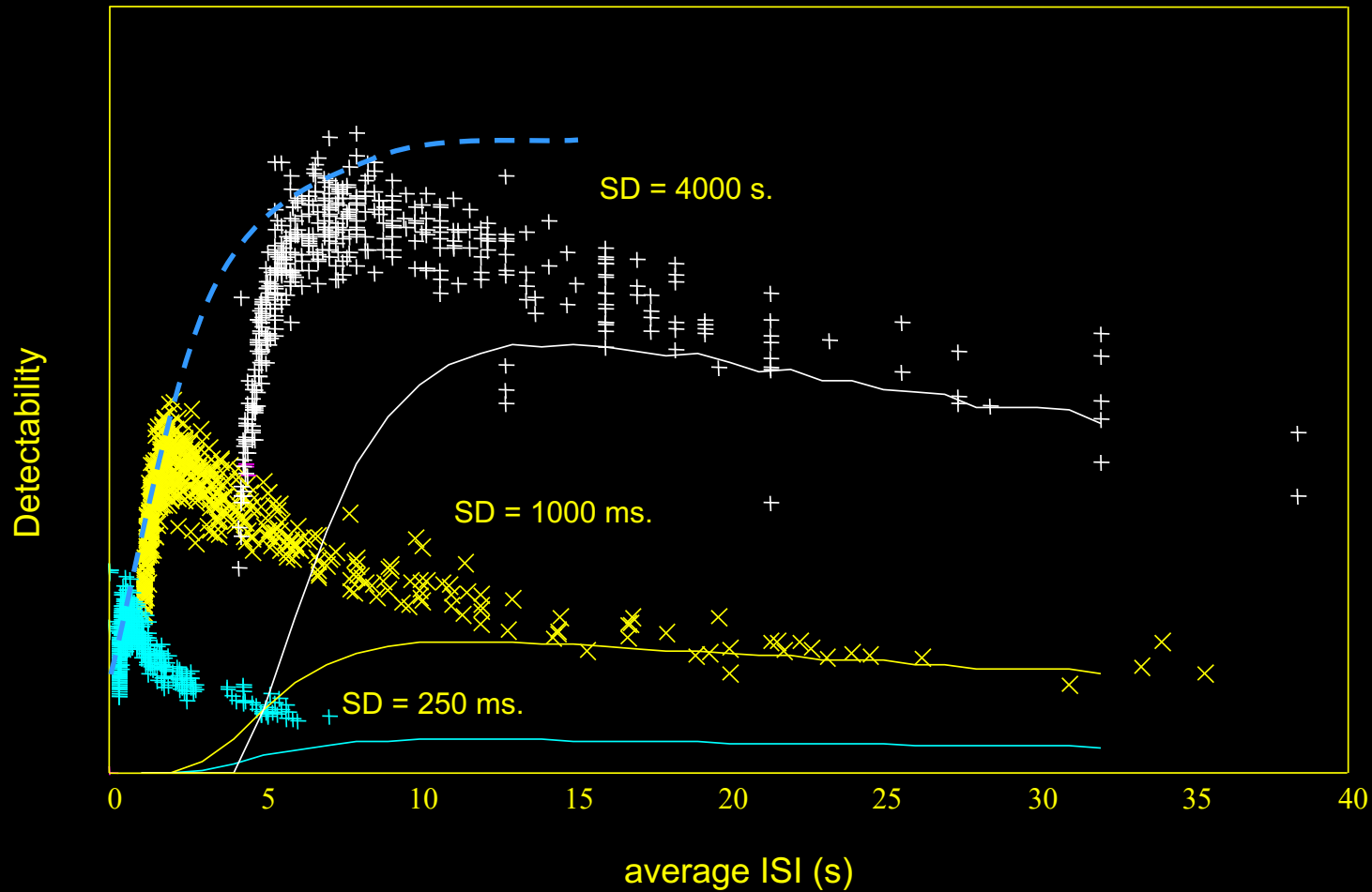

# Estimation accuracy vs. average ISI

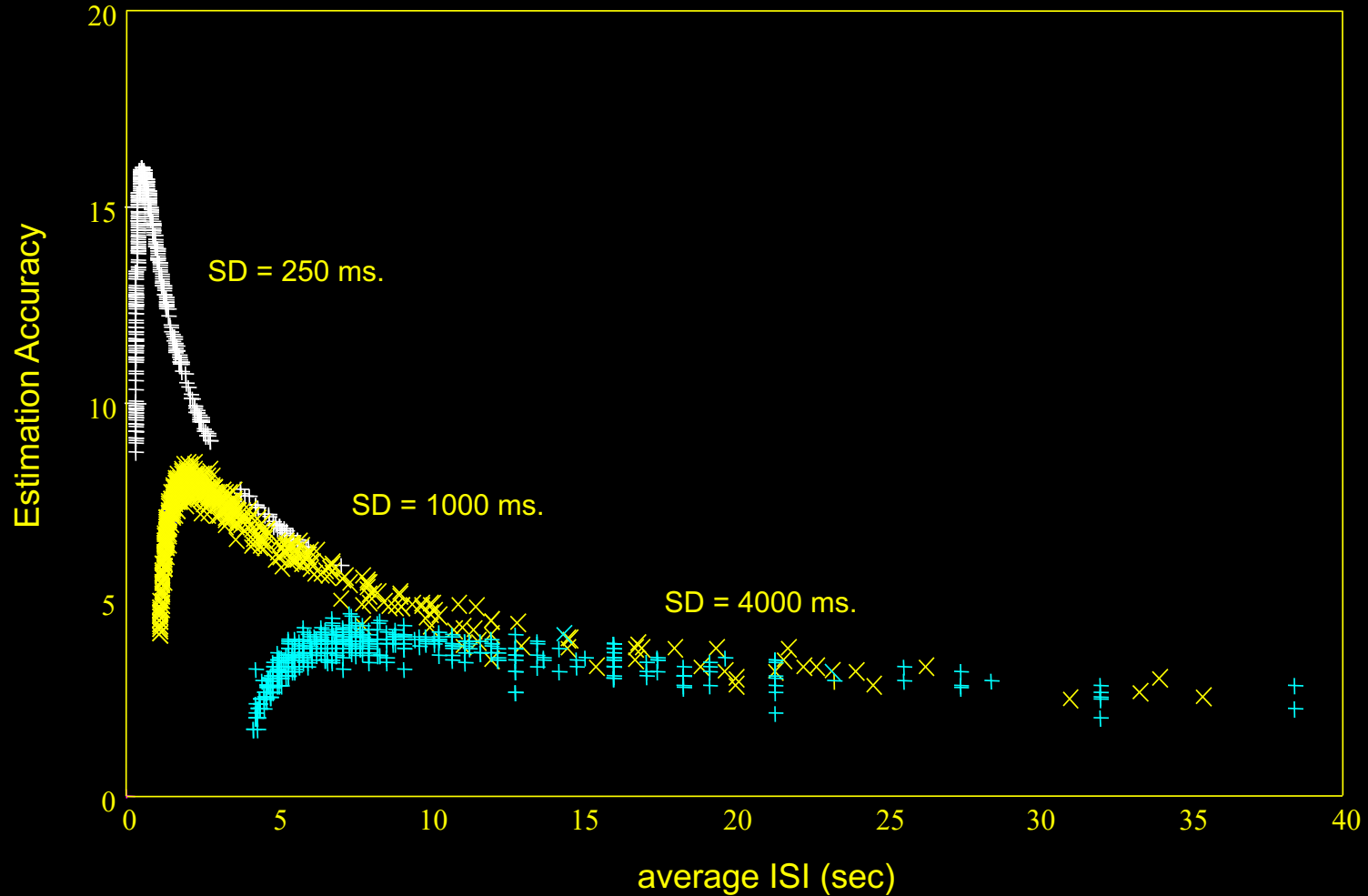

# Speaking - Blocked Trial

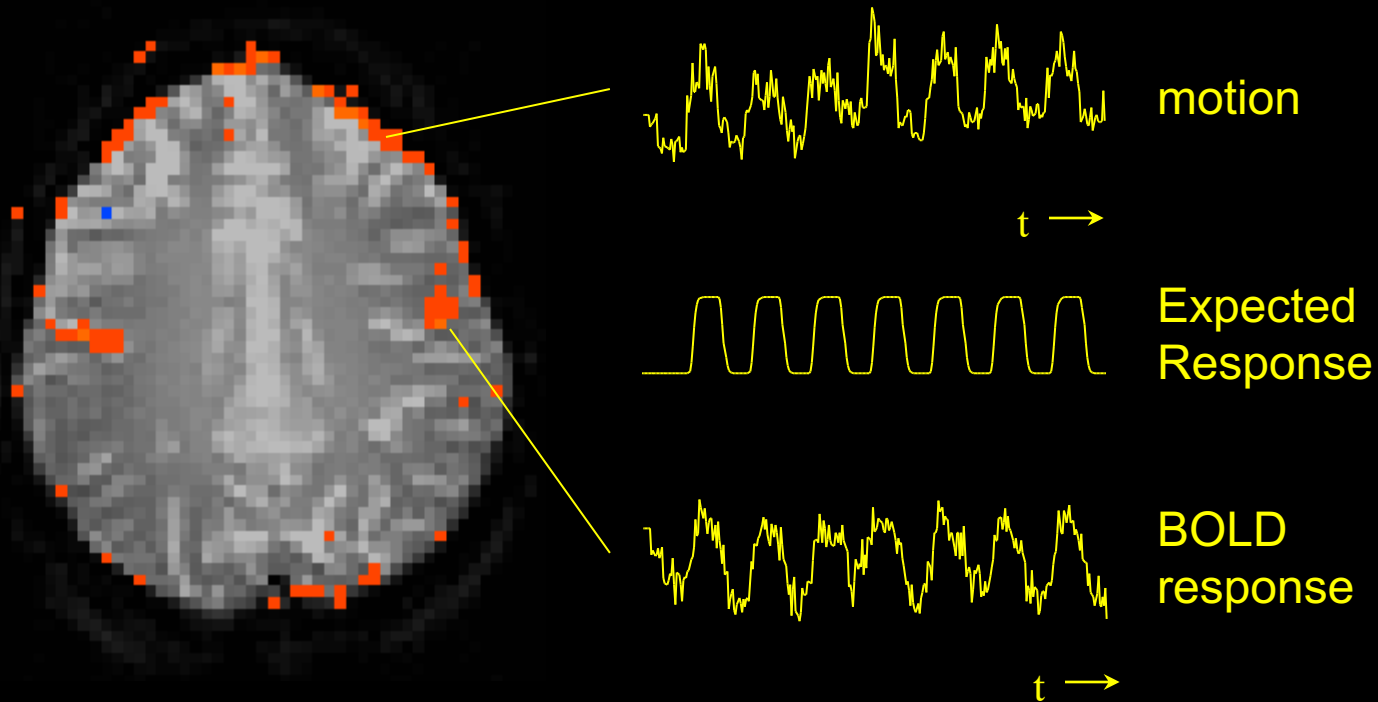

# fMRI during tasks that involve brief motion

## Blocked Design

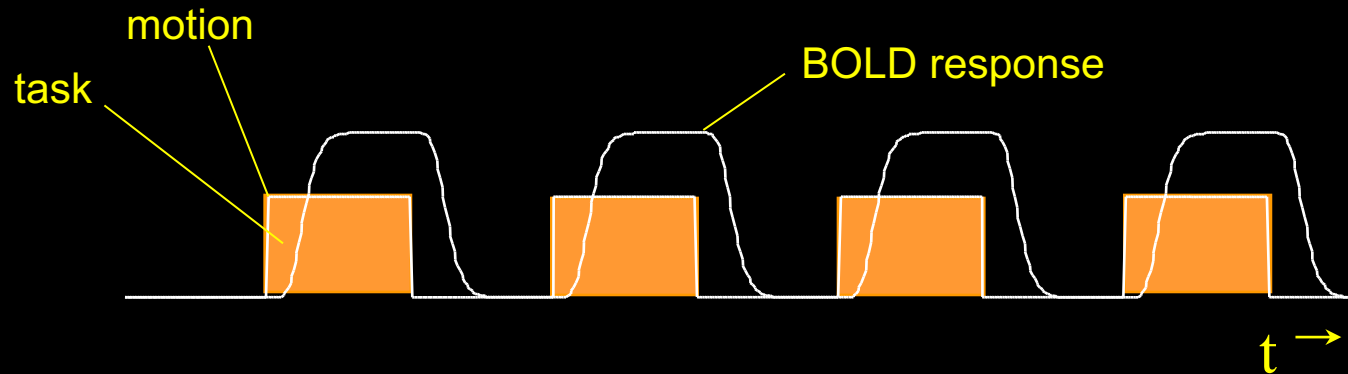

## Event-Related Design

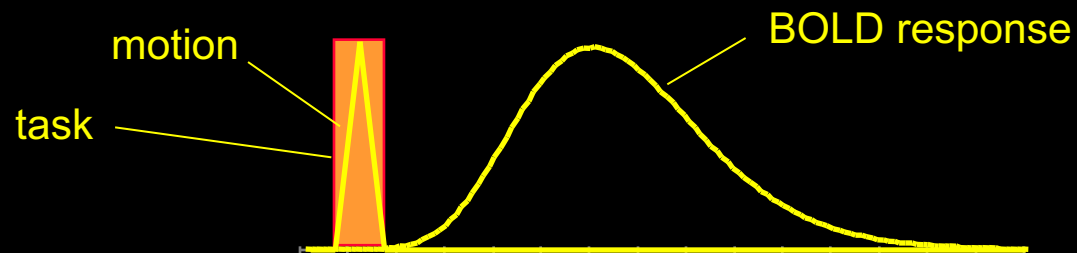

# Overt Word Production

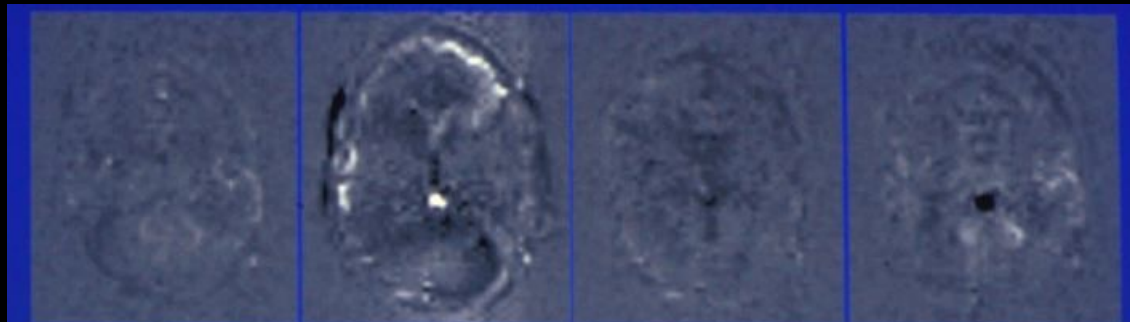

2

3

4

5



6

7

8

9



10

11

12

13

## Motion-Decoupled fMRI: Functional MRI during of overt word production

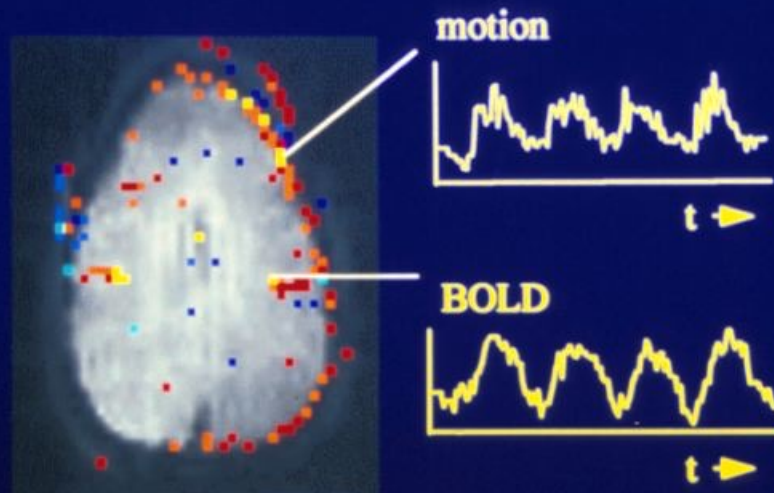

### “block-trial” paradigm

Motion induced signal changes resemble functional (BOLD) signal changes

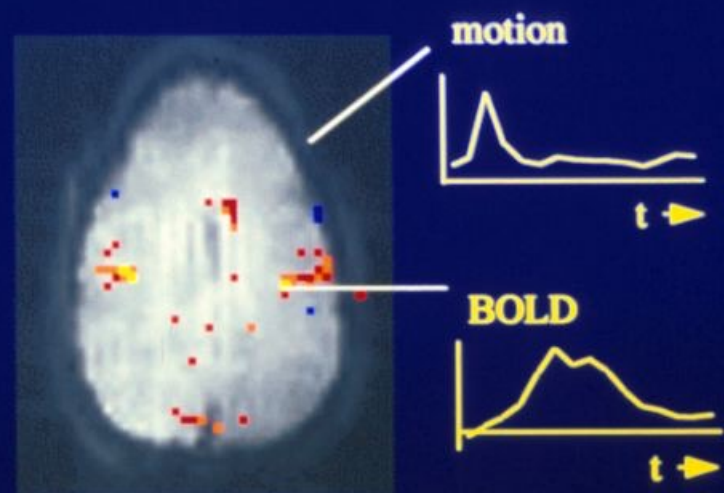

### “single-trial” paradigm

Motion induced and BOLD signal changes are separated in time

*R.M. Birn, et al.*

# Tongue Movement

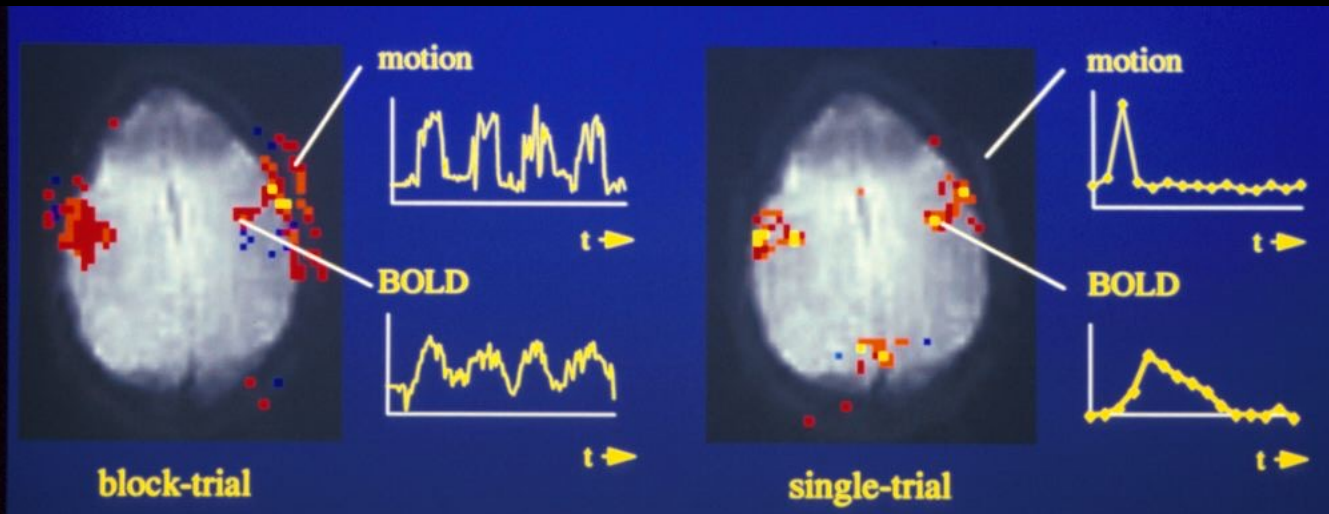

# Jaw Clenching

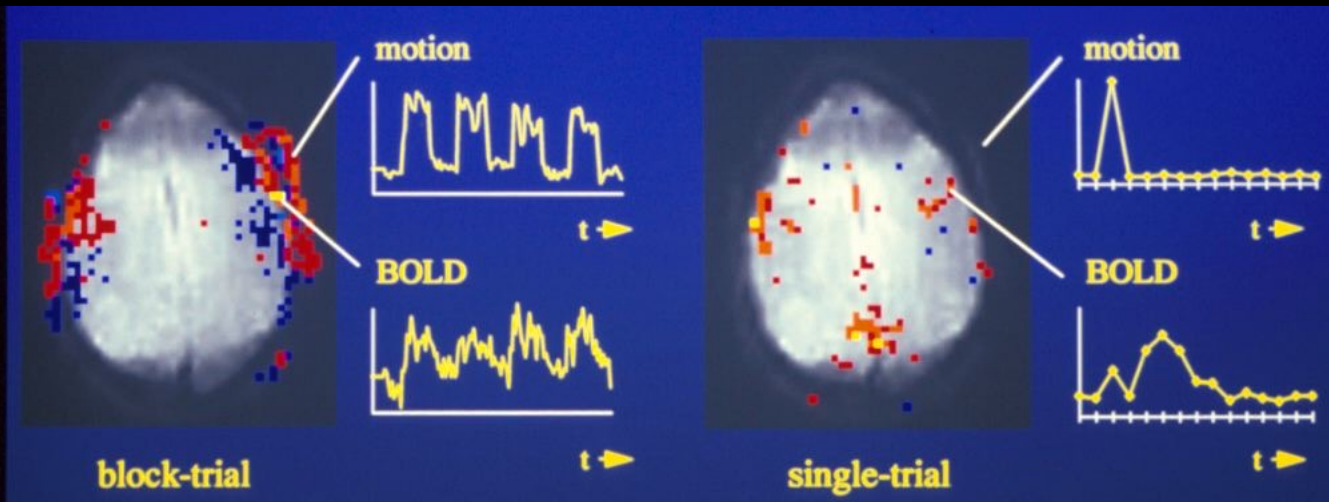

# Constant ISI

## Speaking - ER-fMRI

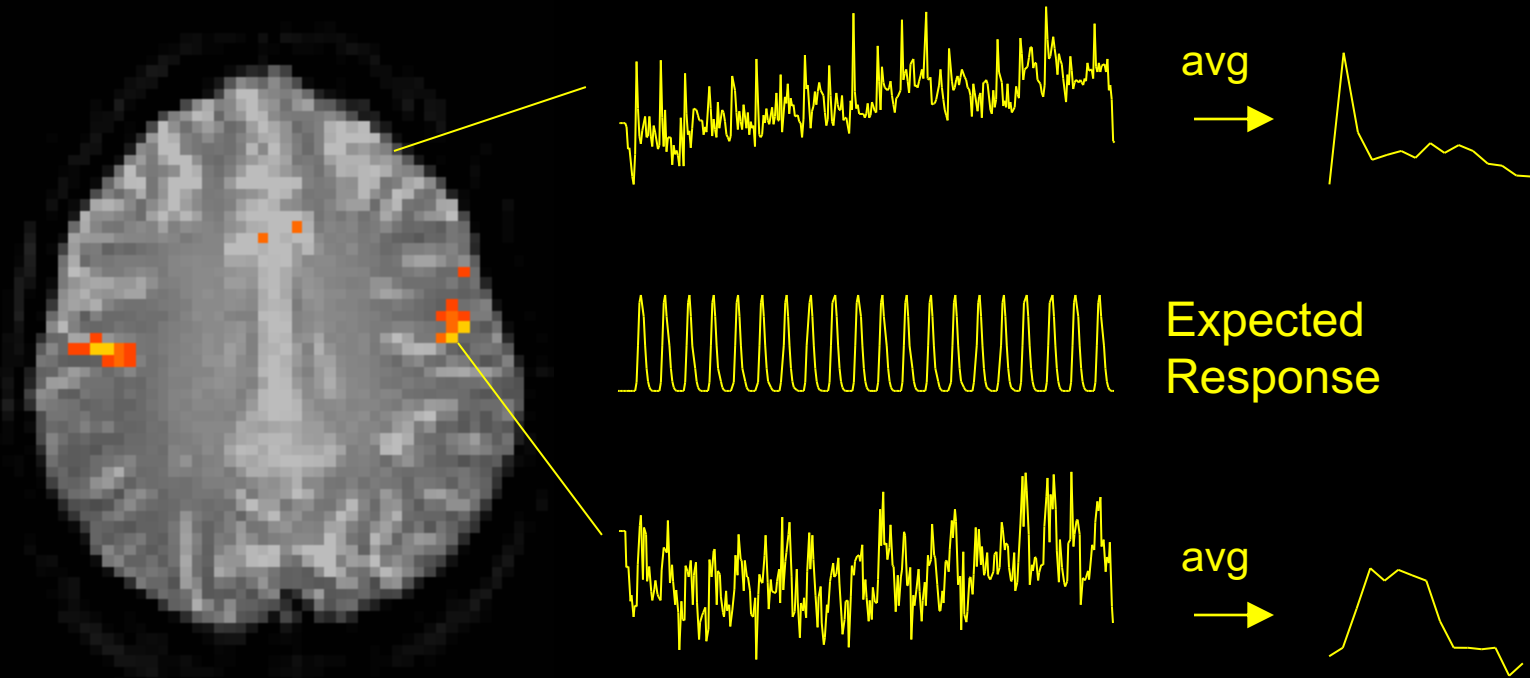



# Swallowing - Event-Related

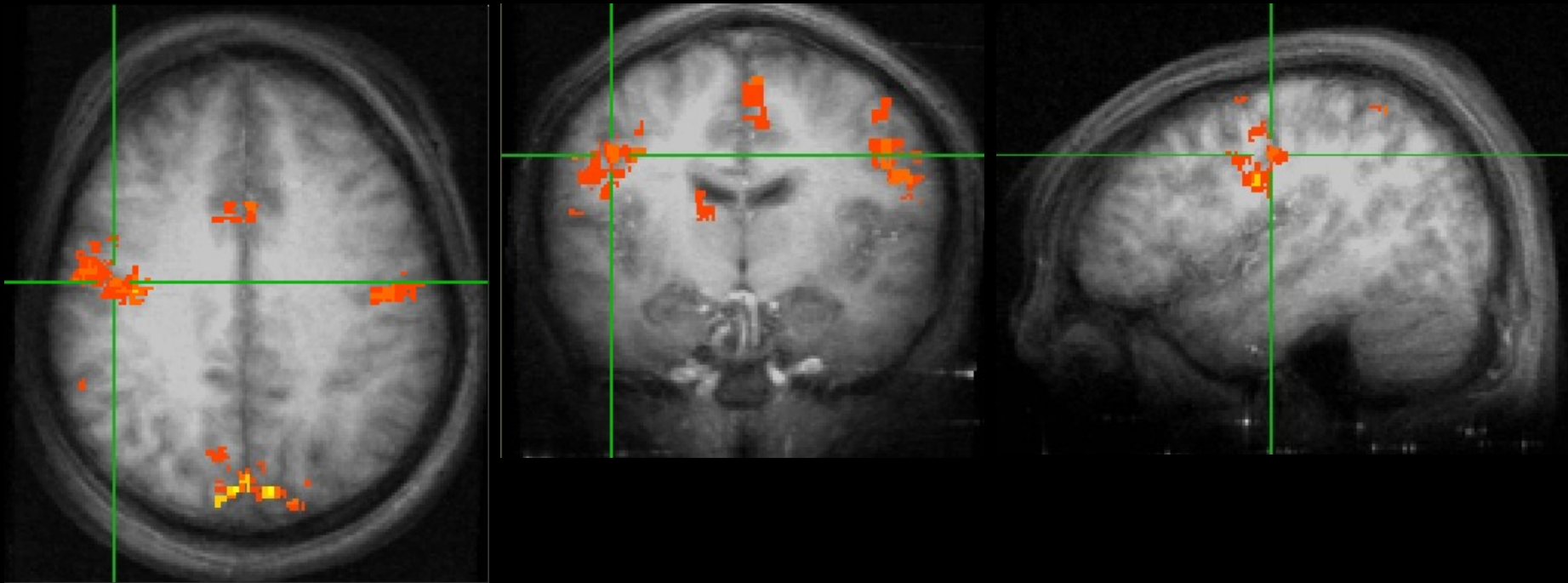

# Neuronal Activation Input Strategies

1. Block Design

2. Frequency Encoding

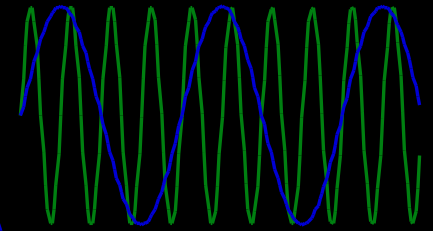

3. Phase Encoding

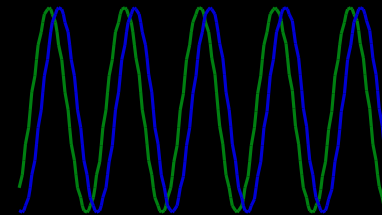

4. Single Event

5. Orthogonal Block Design

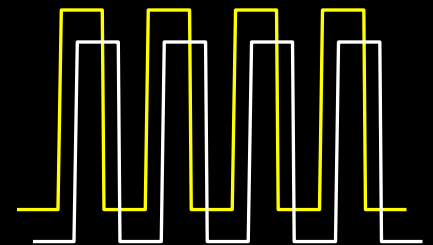

6. Free Behavior Design.

# Example of a Set of Orthogonal Contrasts for Multiple Regression

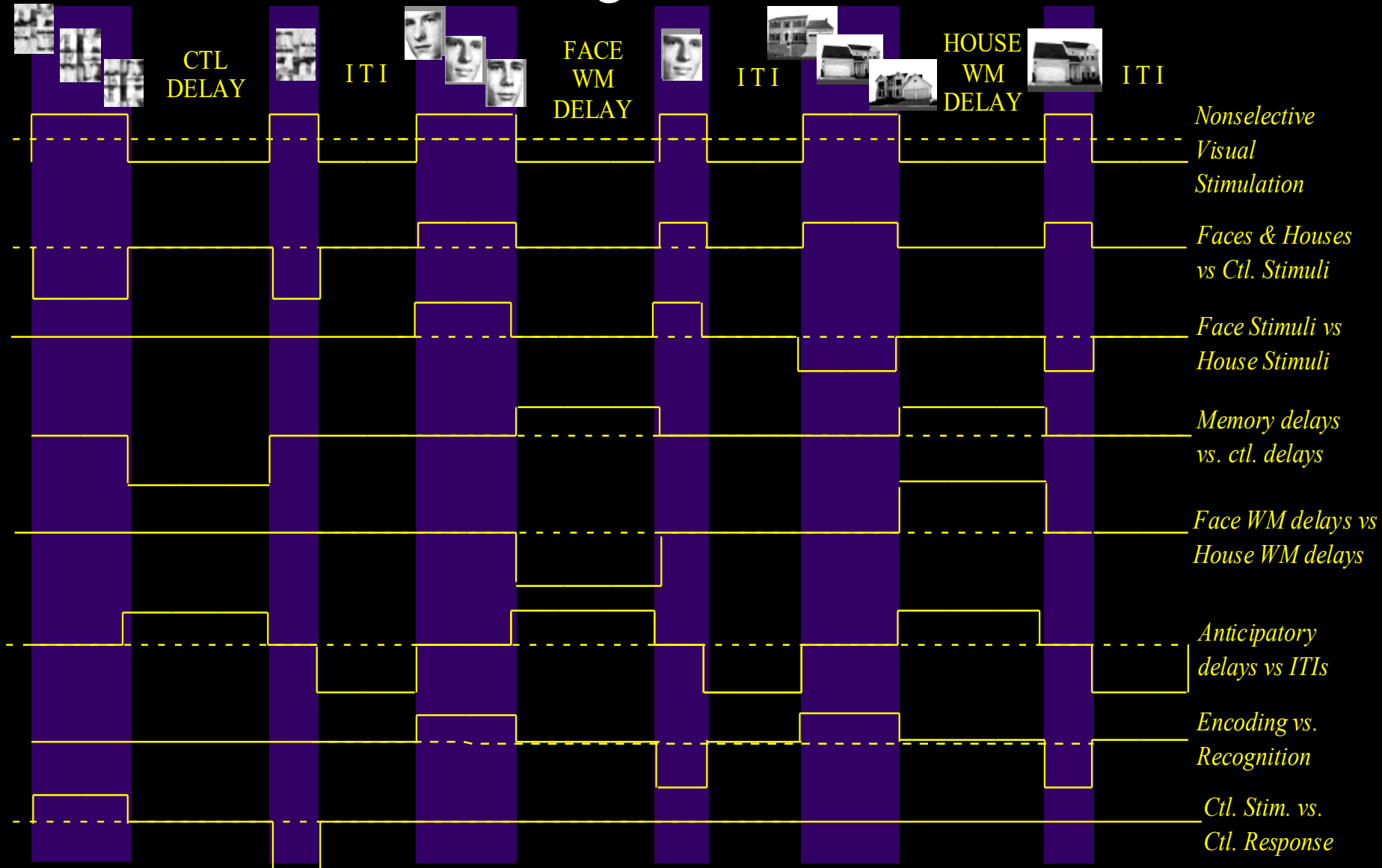

# Neuronal Activation Input Strategies

1. Block Design

2. Frequency Encoding

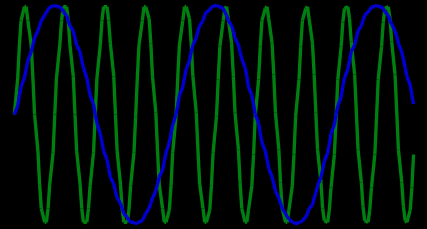

3. Phase Encoding

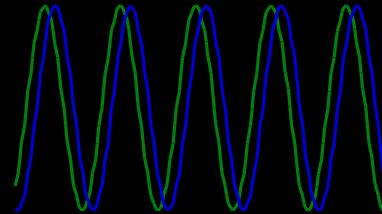

4. Single Event

5. Orthogonal Block Design

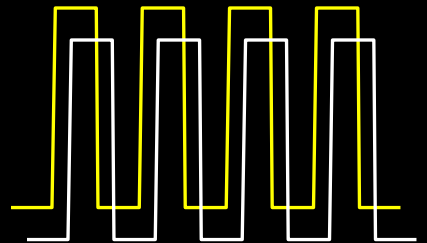

6. Free Behavior Design.

# Free Behavior Design

Use a continuous measure as a reference function:

- Task performance
- Skin Conductance
- Heart, respiration rate..
- Eye position
- EEG

# Resting Hemodynamic Autocorrelations

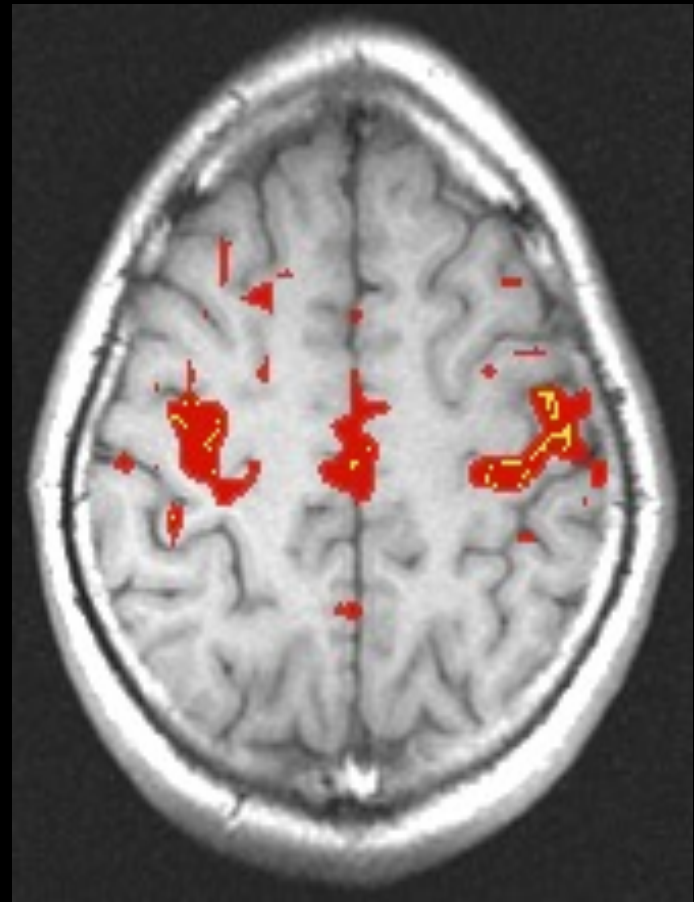
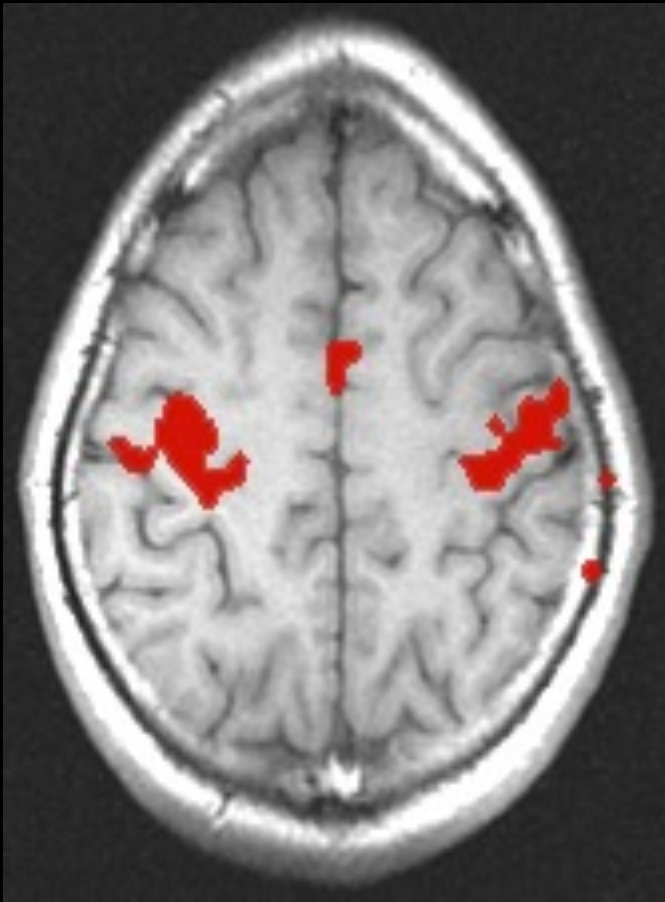

# The Skin Conductance Response (SCR)

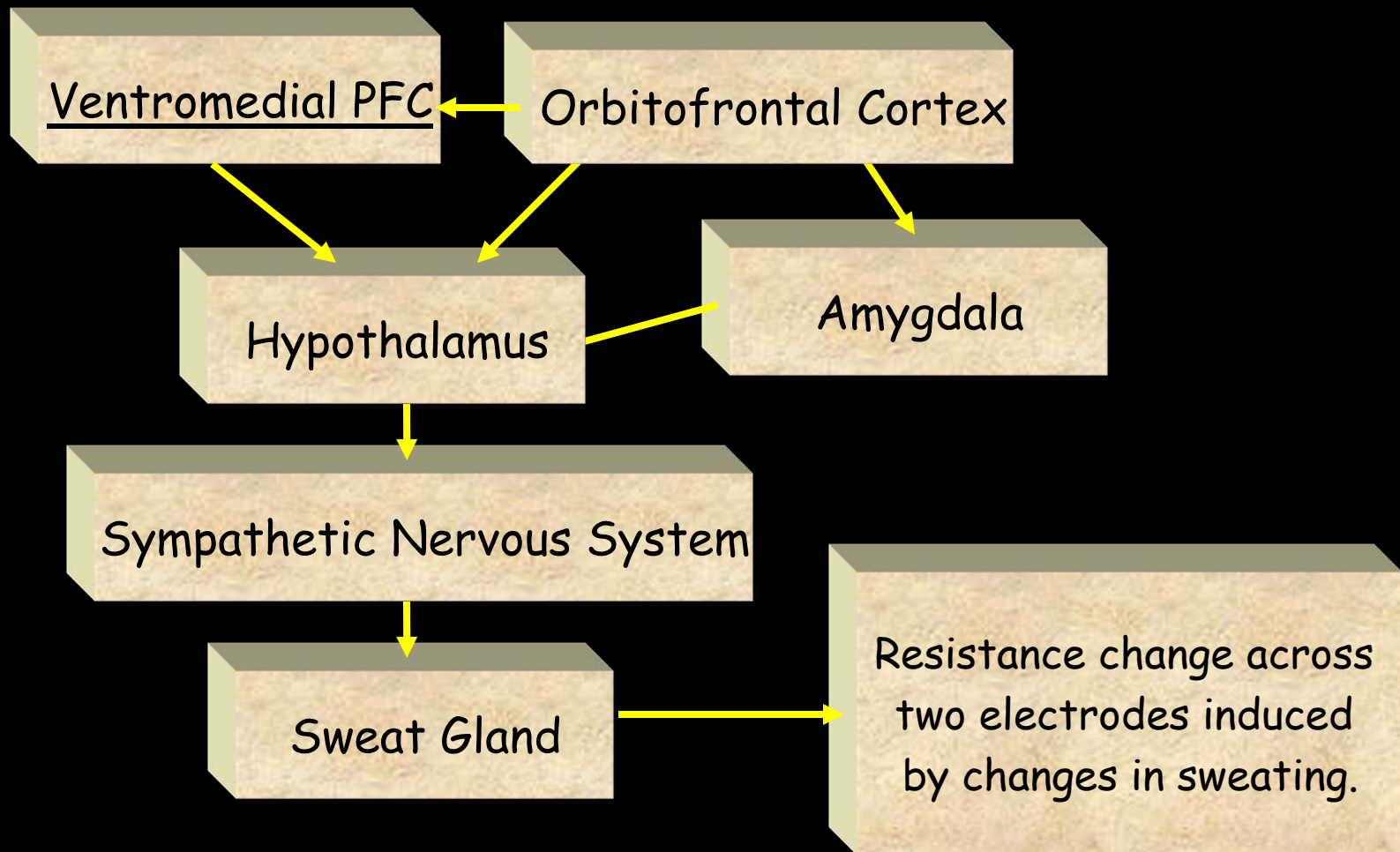

# Skin Conductance Dynamics

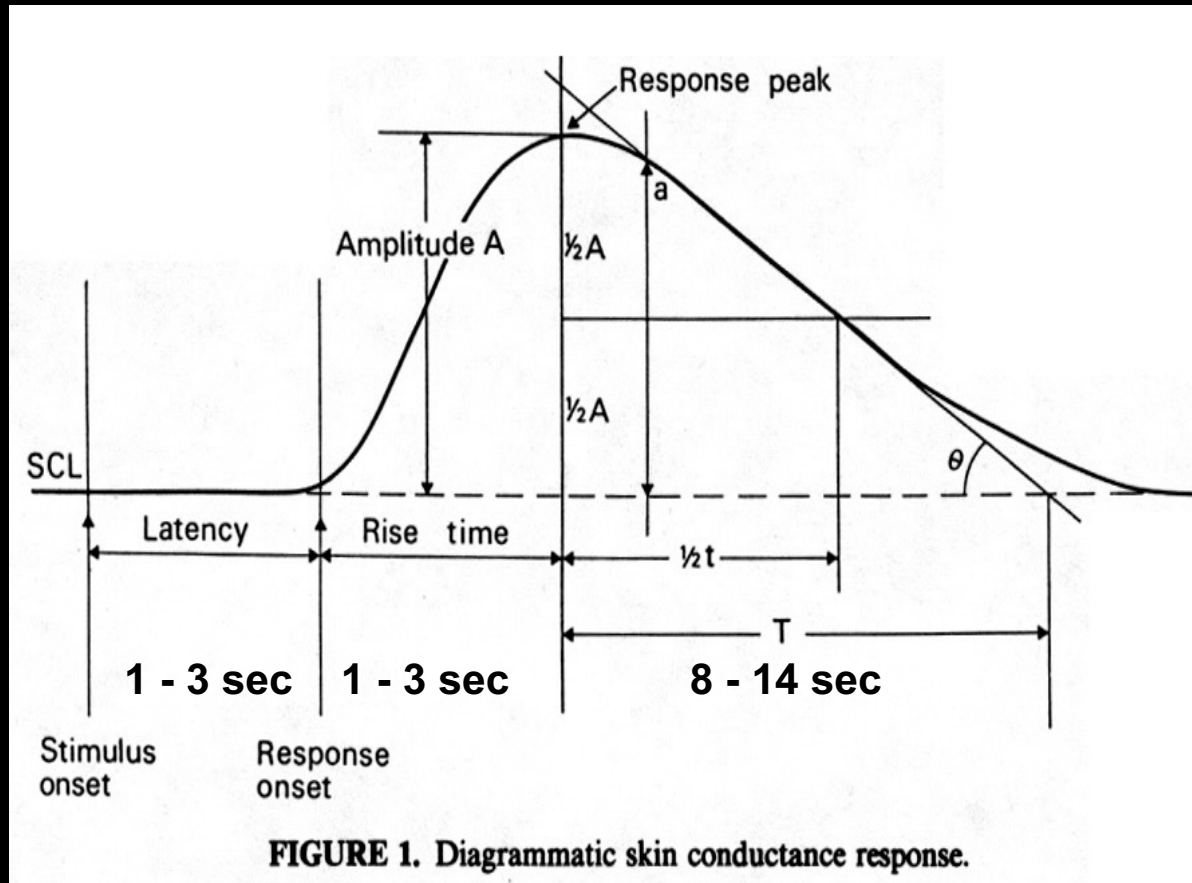

- Boucsein, Wolfram (1992). *Electrodermal Activity*. Plenum Press, NY
- Venables, Peter, (1991). *Autonomic Activity ANYAS 620:191-207*.



# Correlation with Resting-State Skin Conductance

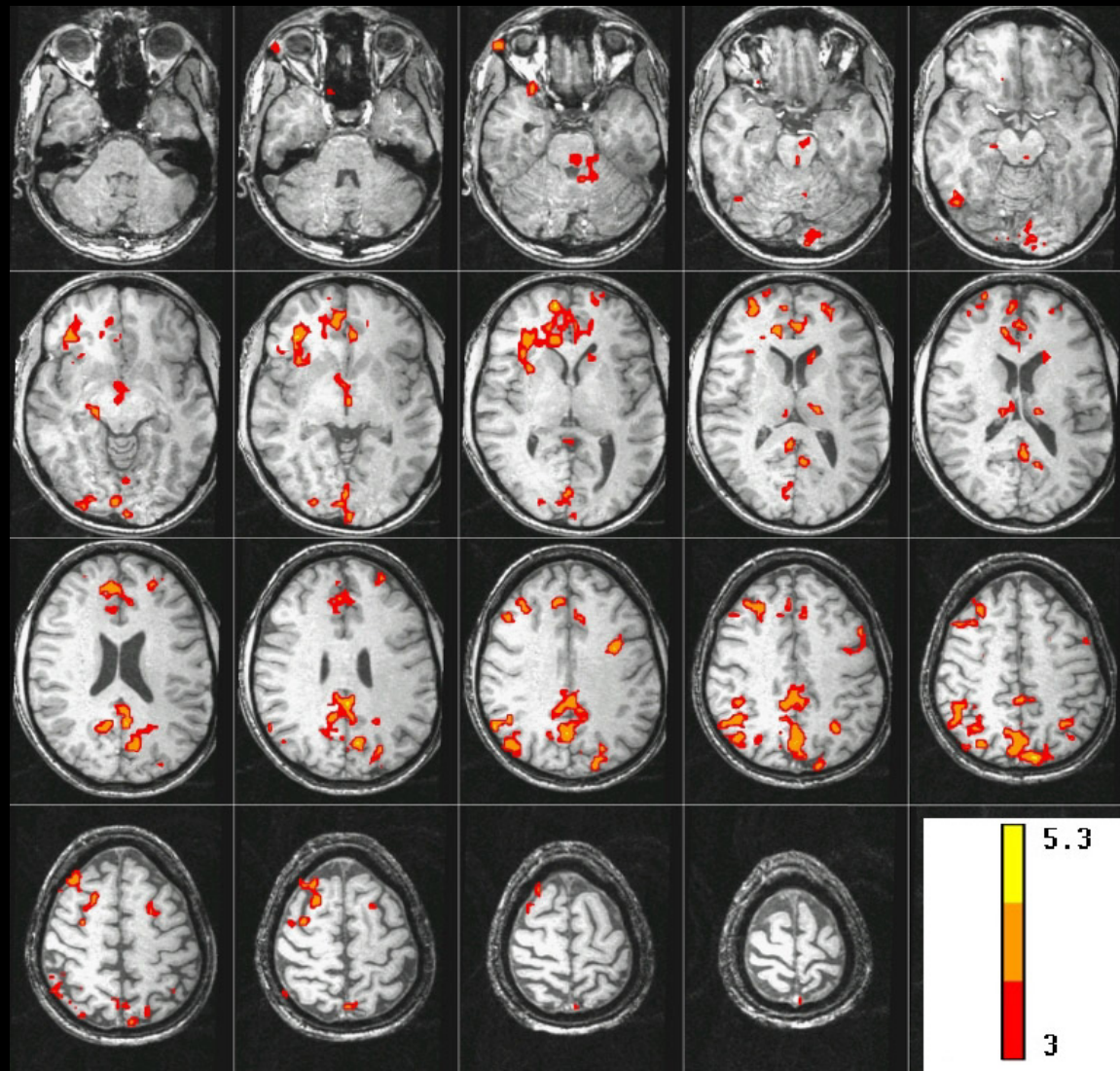

Patterson et al.

# Brain activity correlated with SCR during “Rest”

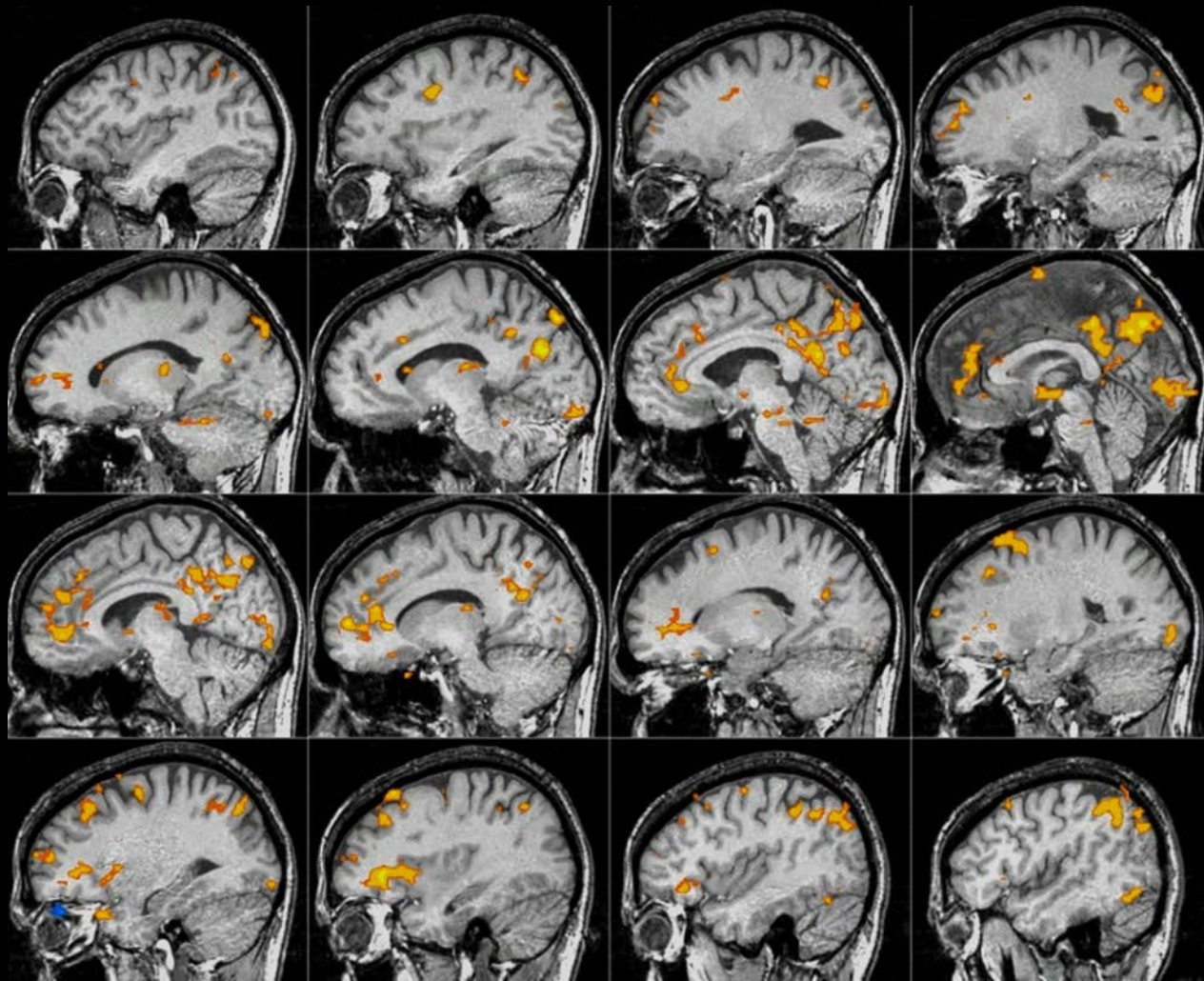

**Left**

**Simple Finger Movement on the Left Hand**

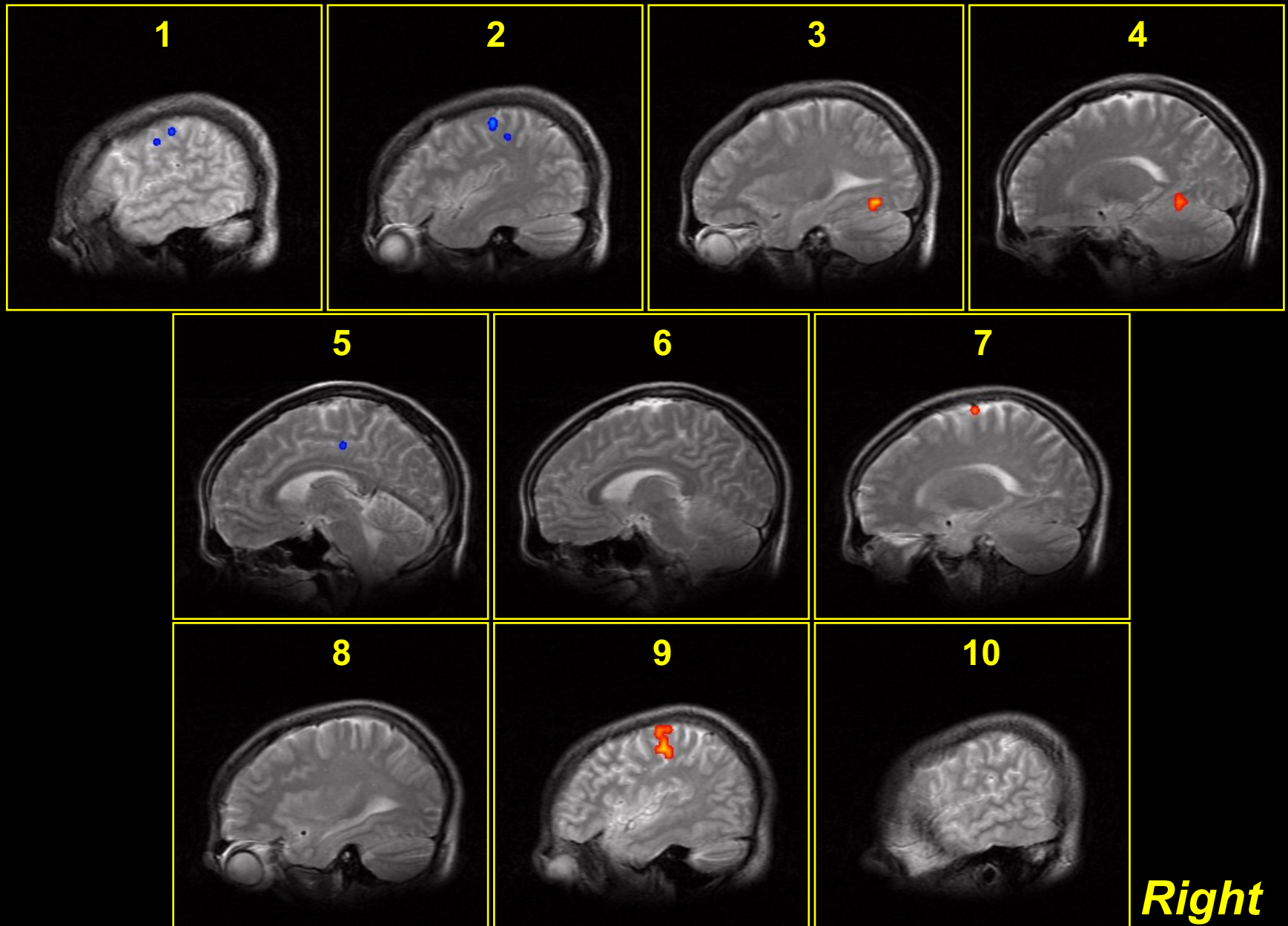

**Right**

**Left**

**Simple Finger Movement on the Right Hand**

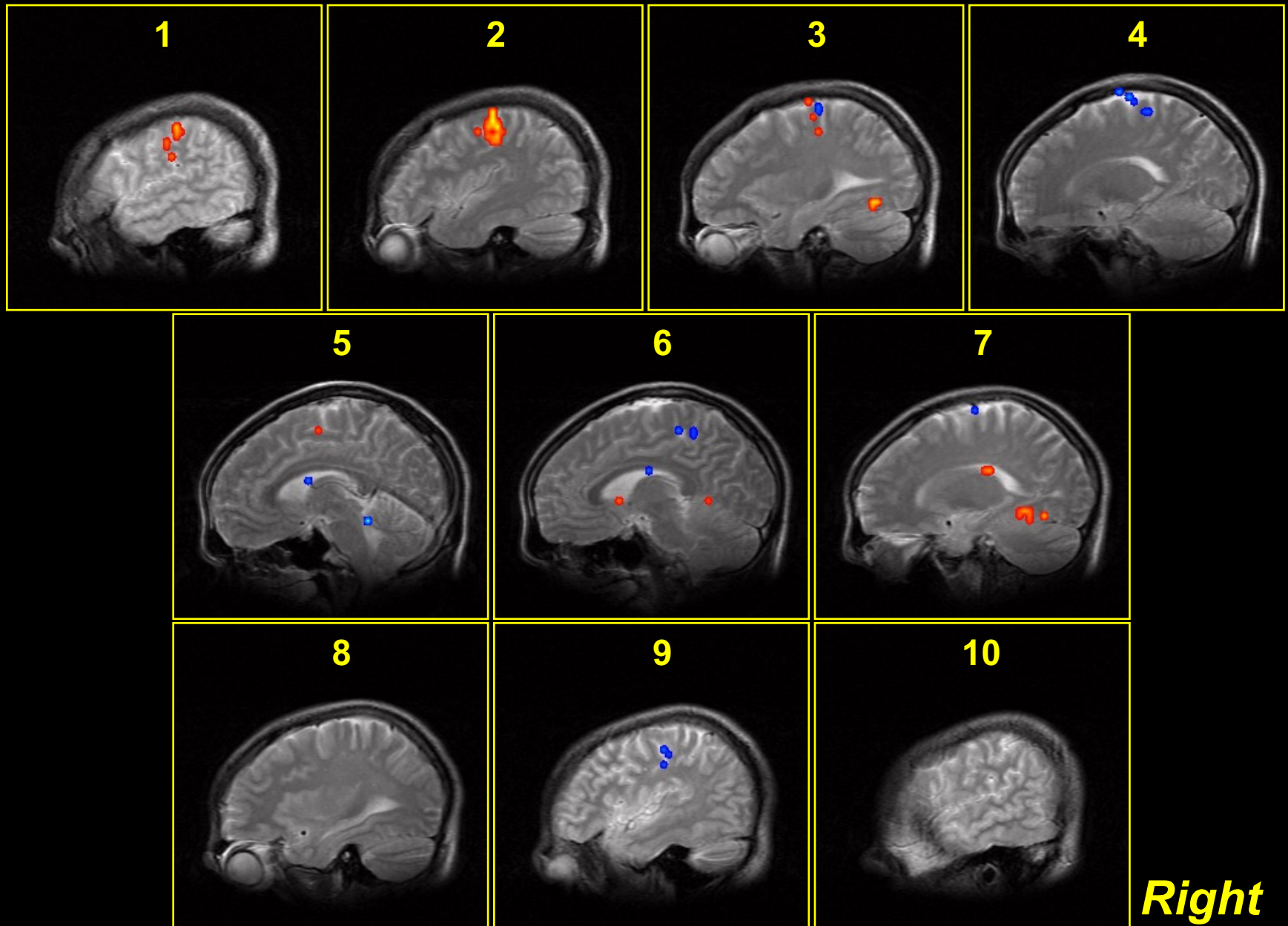

**Right**

**Left**

**Complex Finger Movement on the Right Hand**

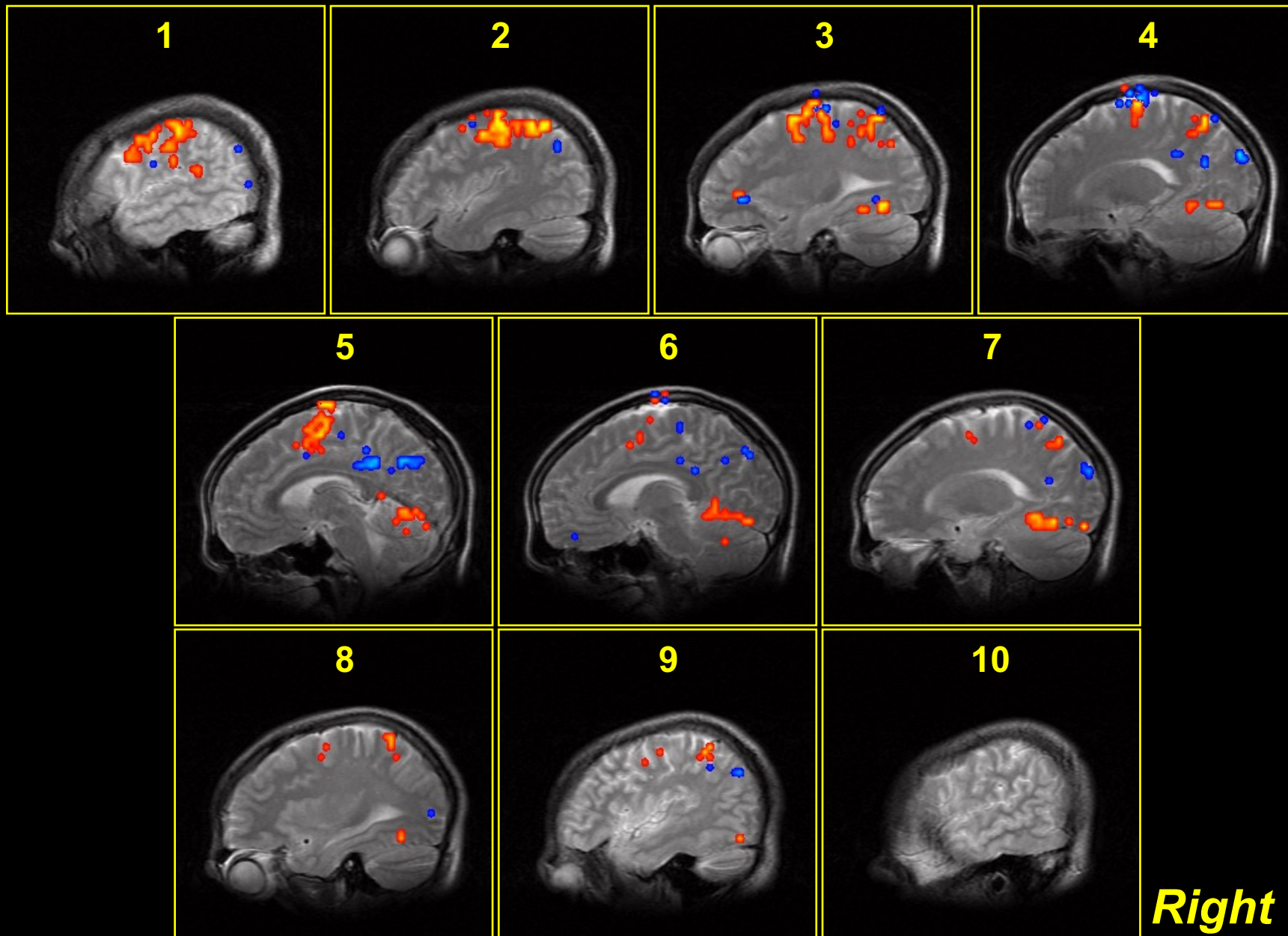

**Right**

**Left**

**Complex Finger Movement on the Left Hand**

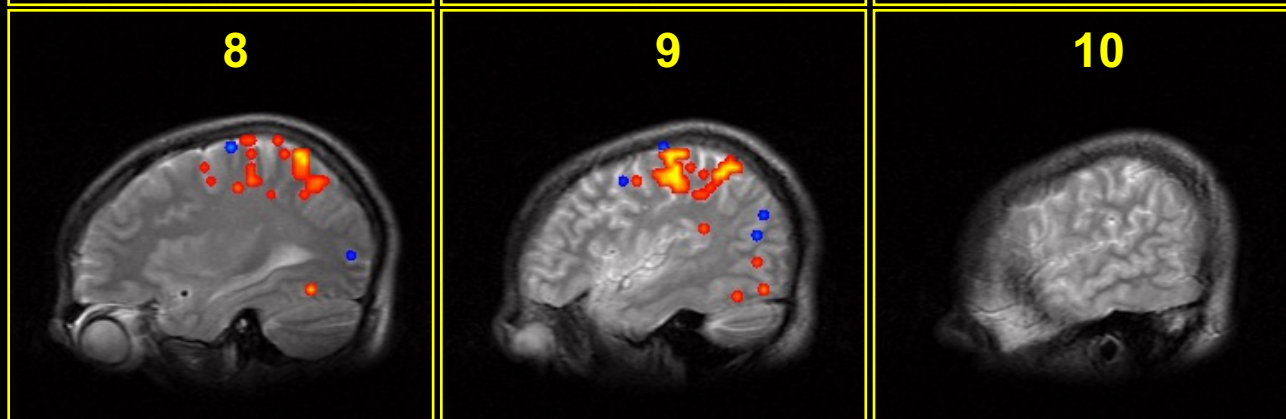
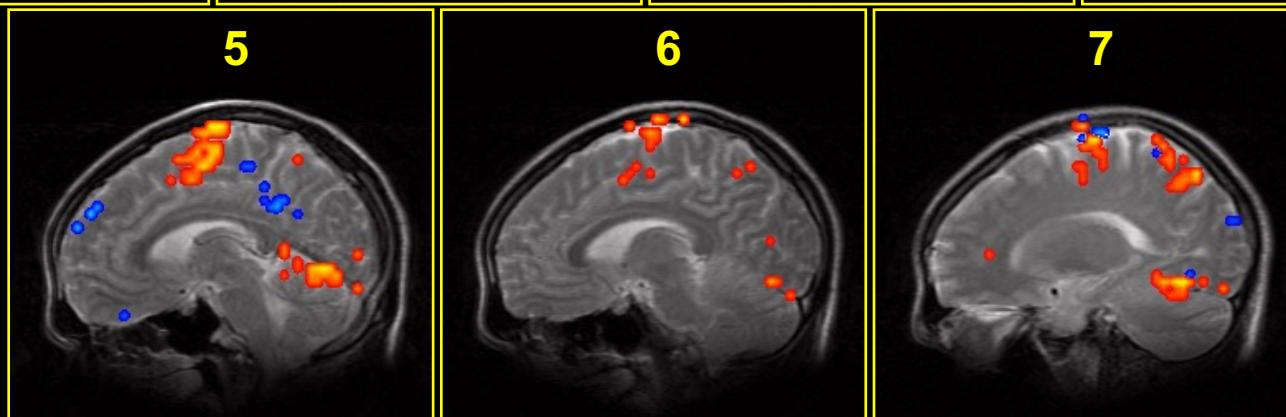
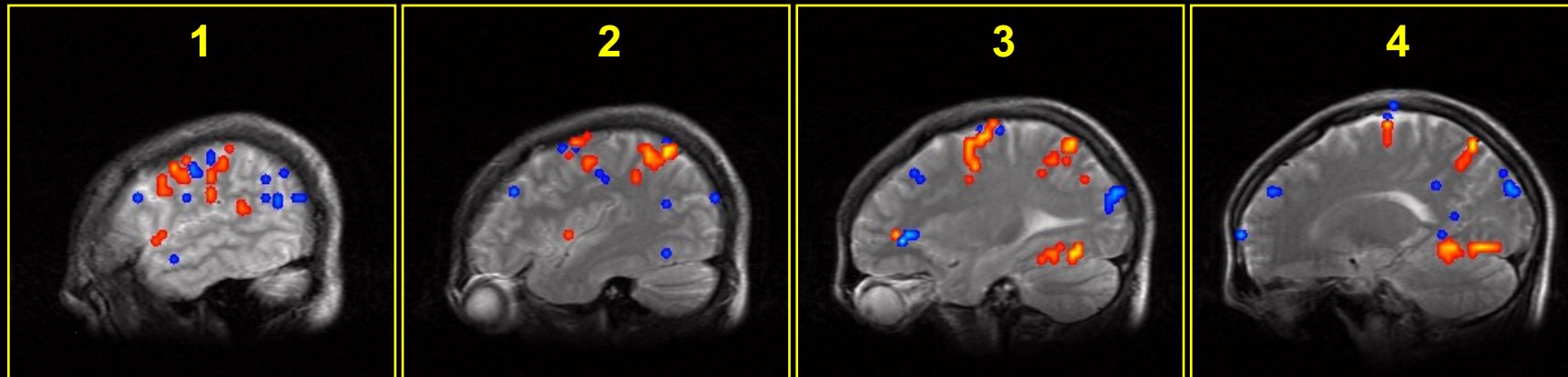

**Right**

**Left**

**Imagined Complex Finger Movement on the Left Hand**

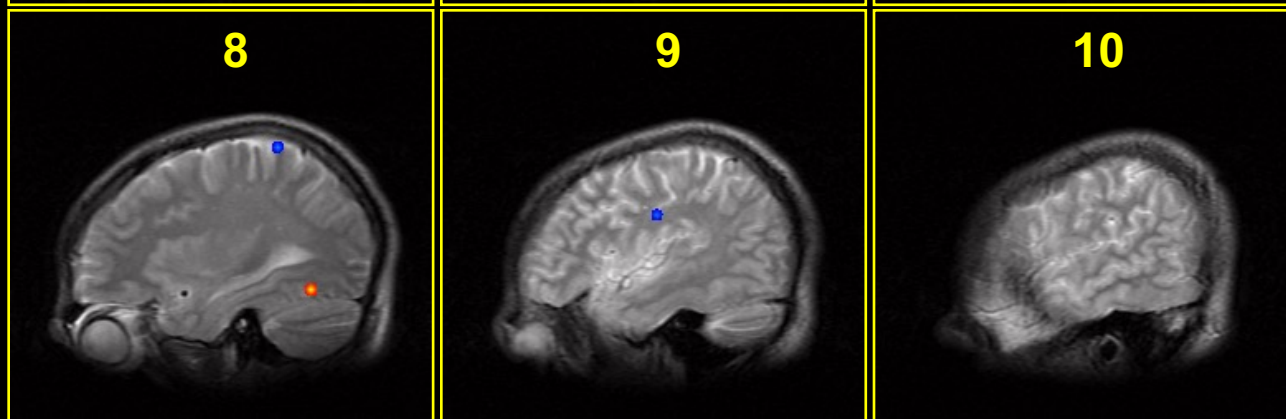
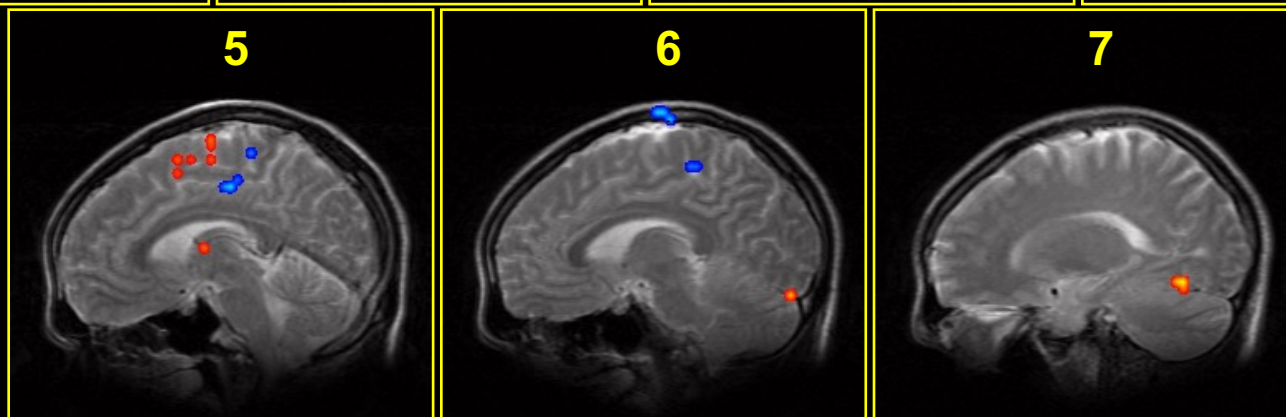
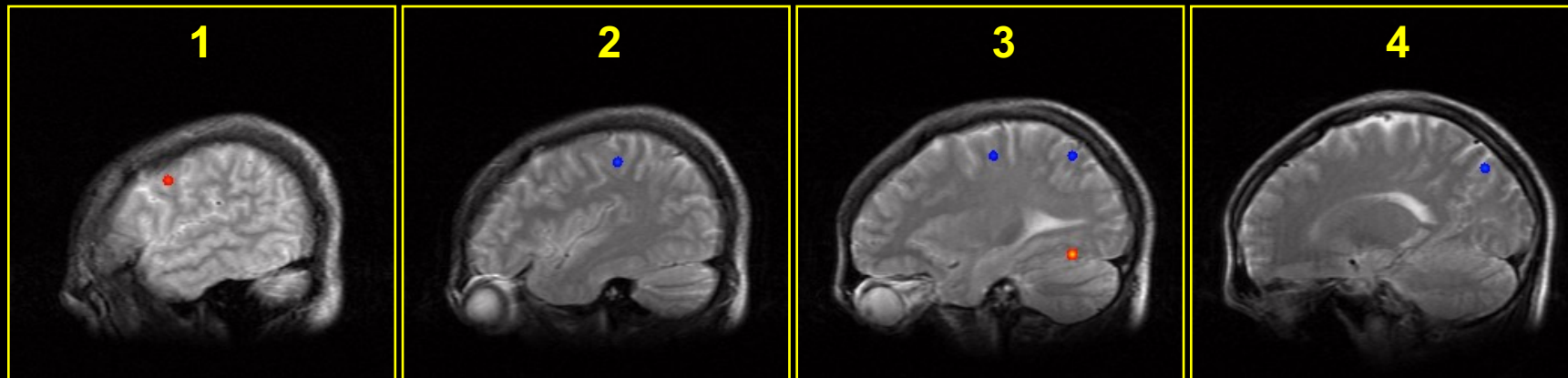

**Right**

**Left**

**Imagined Complex Finger Movement on the Right Hand**

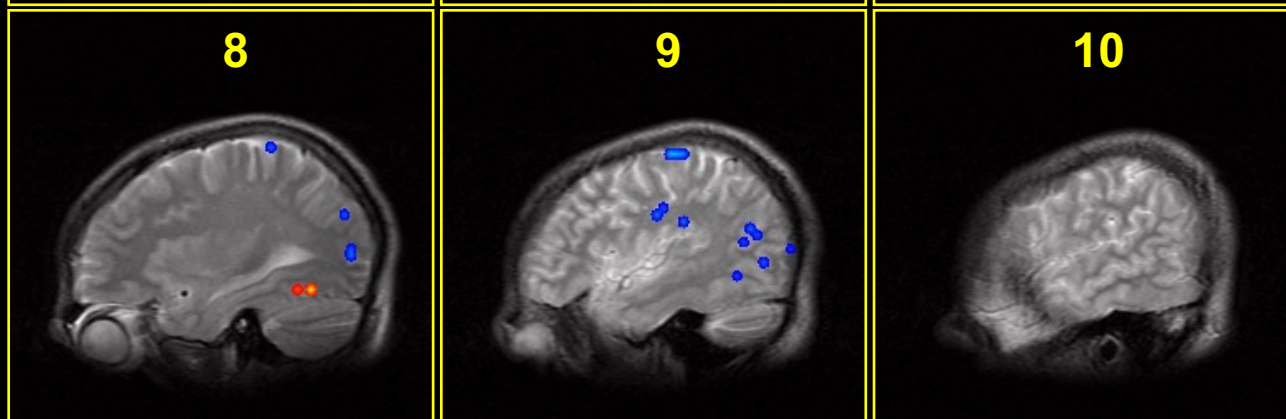
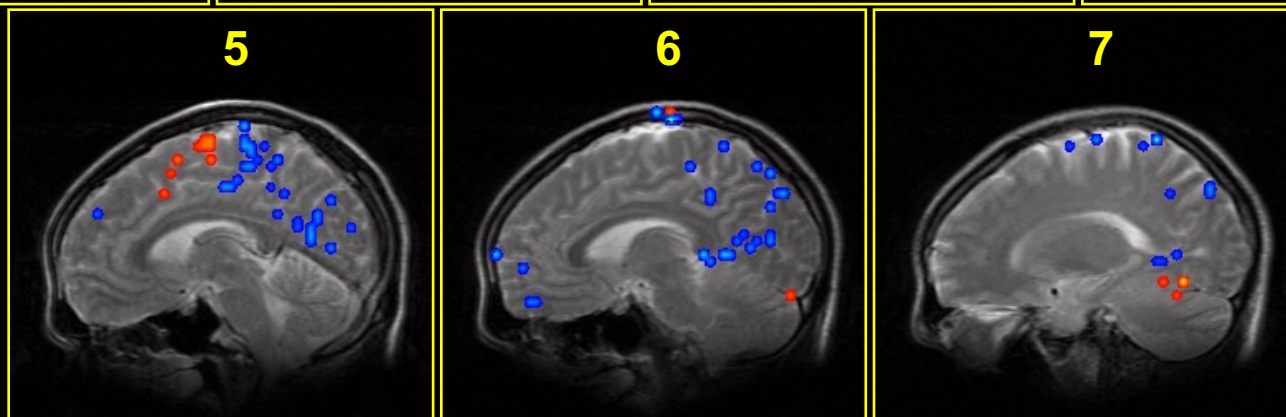
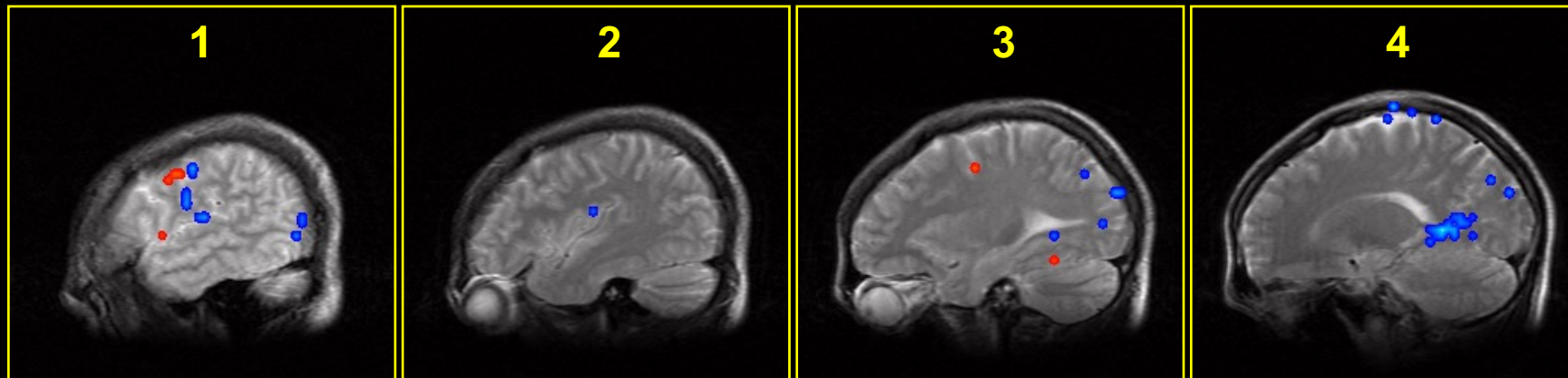

**Right**



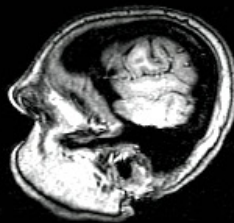
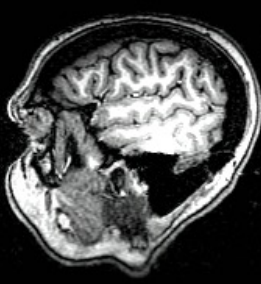
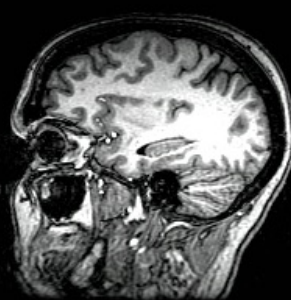
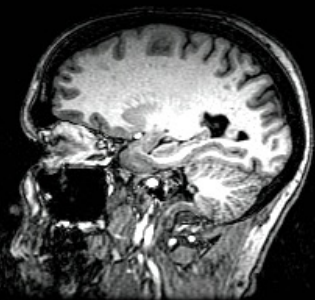
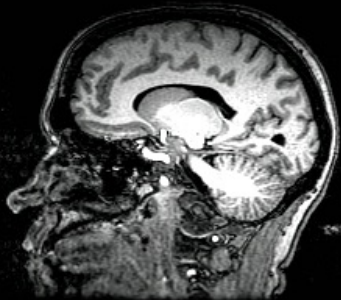
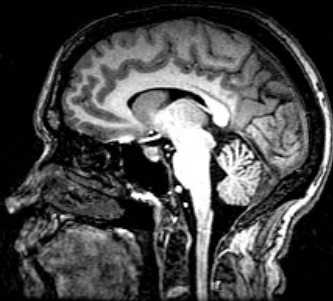
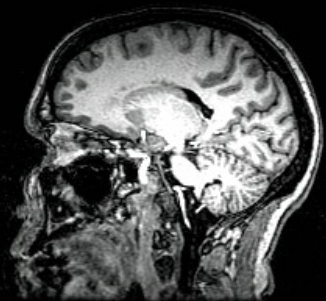

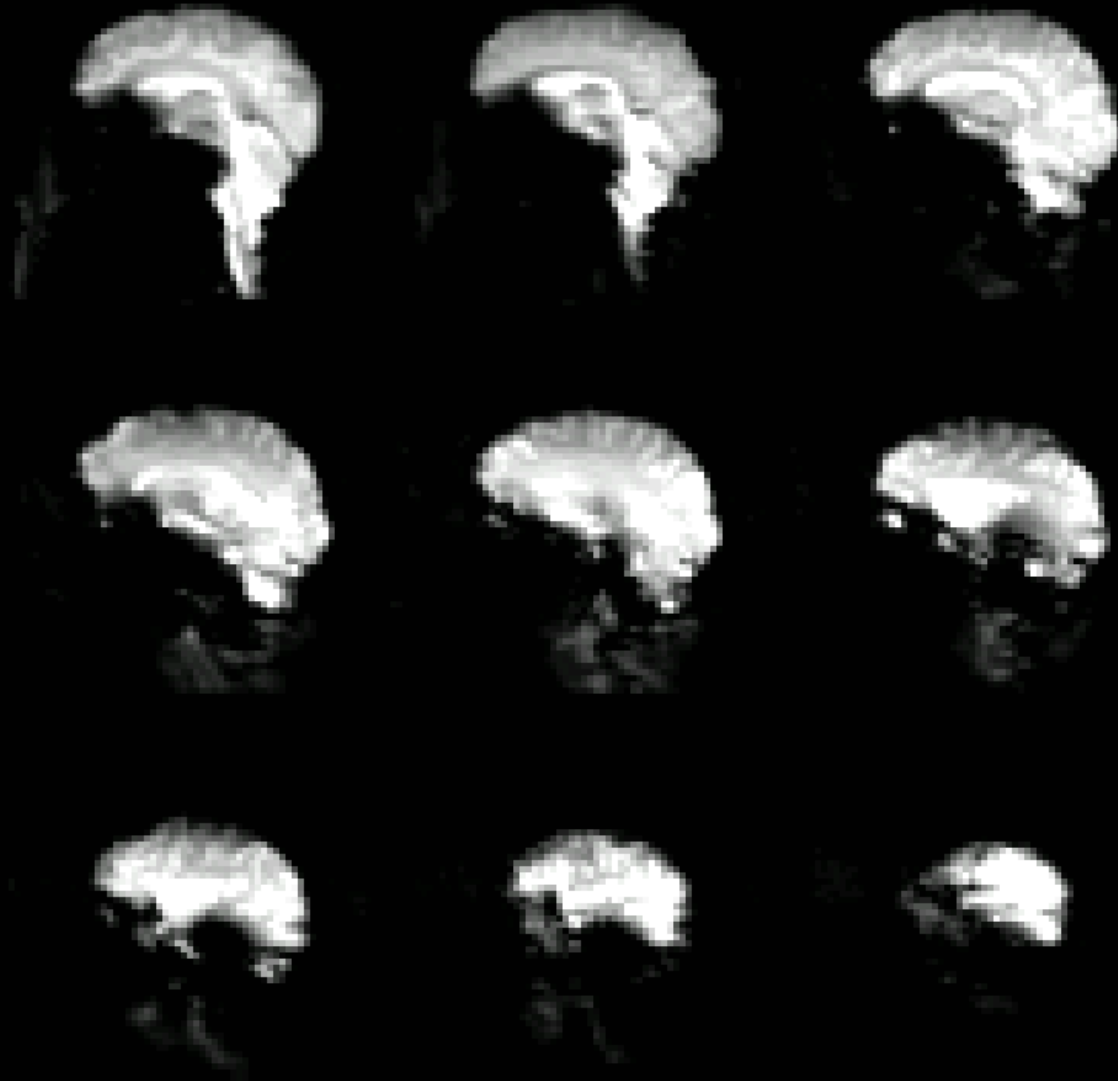

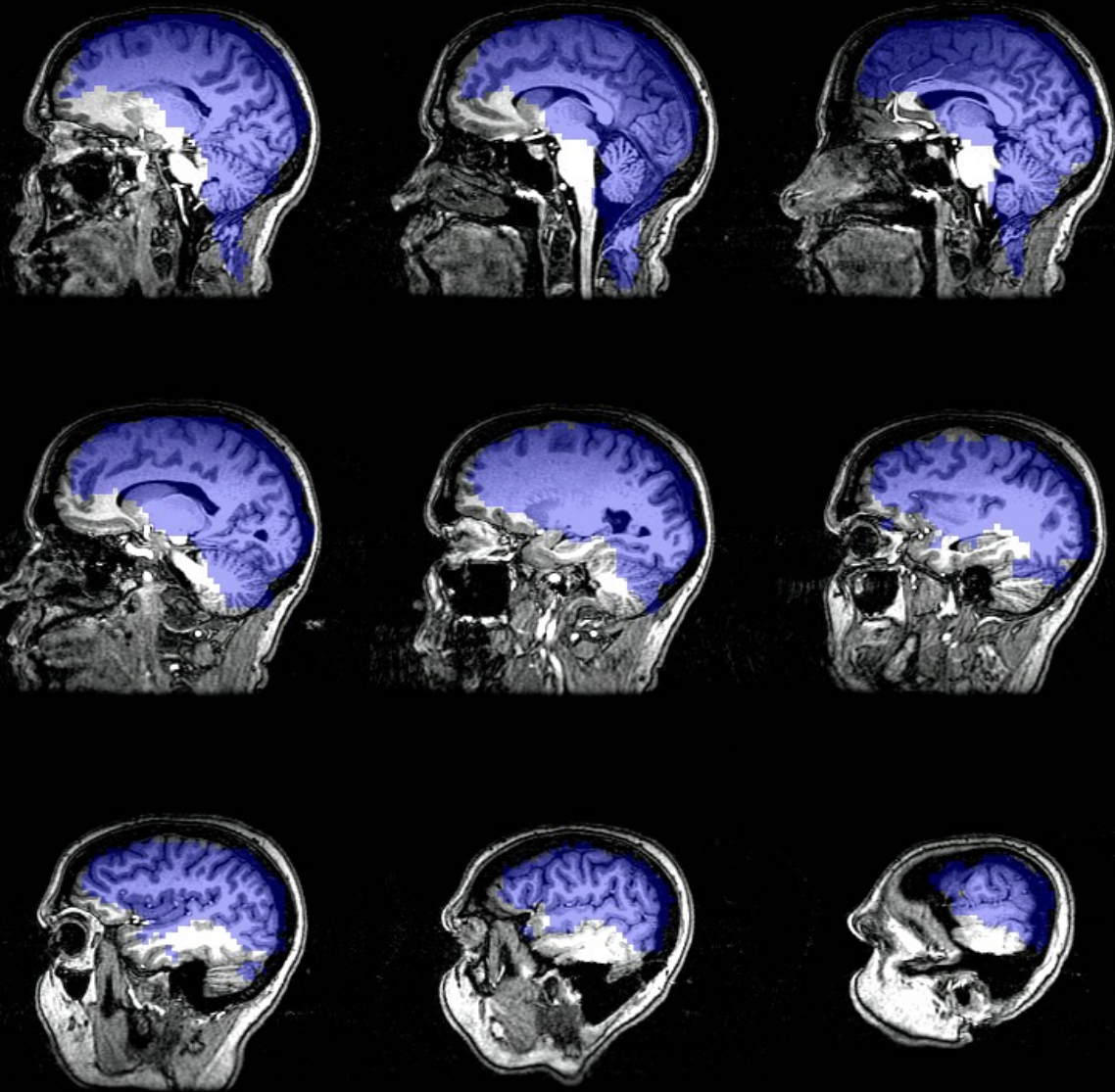

## 3D z-Shim Method for Reduction of Susceptibility Effects in BOLD fMRI

Gary H. Glover\*

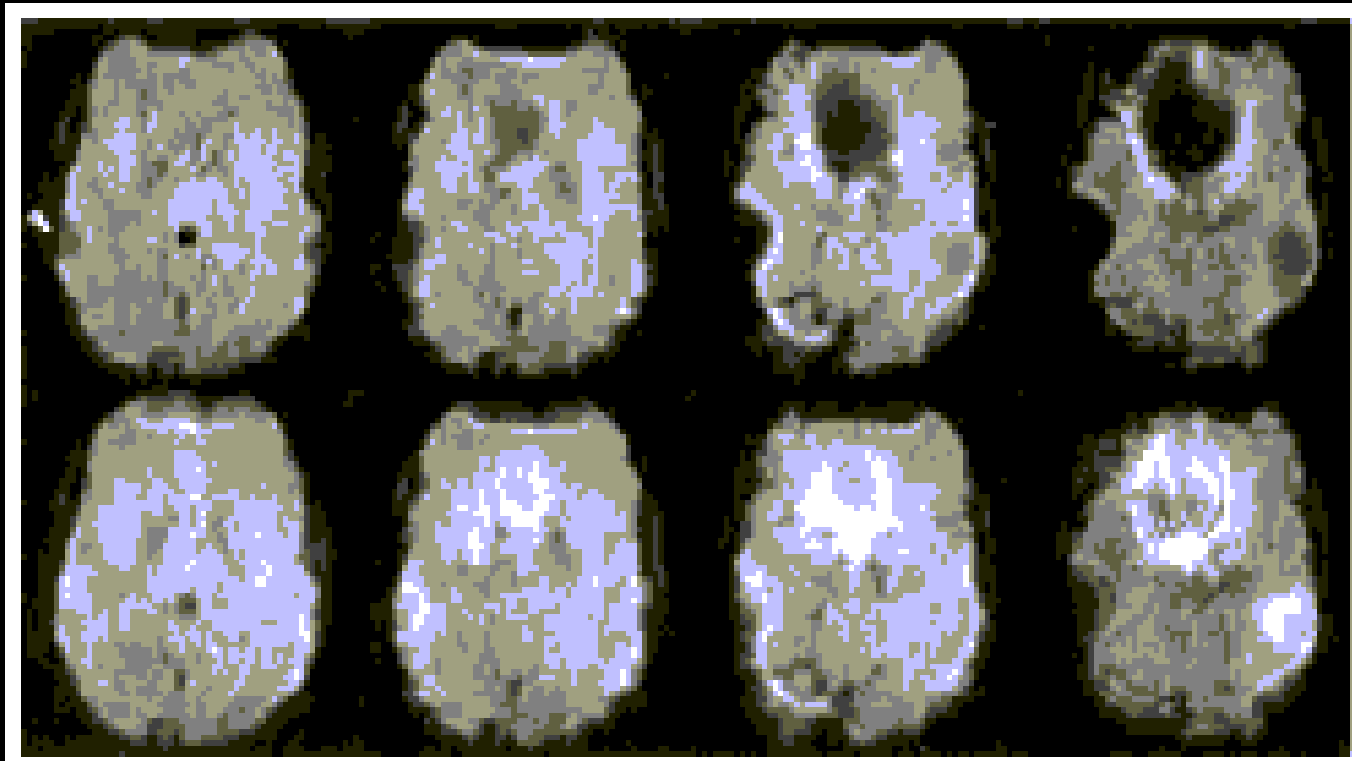

- **Contrast in fMRI**

*Hemodynamic Specificity*

- **The Hemodynamic Transfer Function**

*Location, Latency, Magnitude*

- **Best Results So Far**

*Temporal Resolution, Spatial Resolution*

- **Neuronal Activation Input Strategies**

*Block Design*

*Phase and Frequency Encoding*

*Orthogonal Designs*

*Parametric Designs*

*Event-Related Designs*

*Free Behavior Designs*

# Sensorimotor Mapping

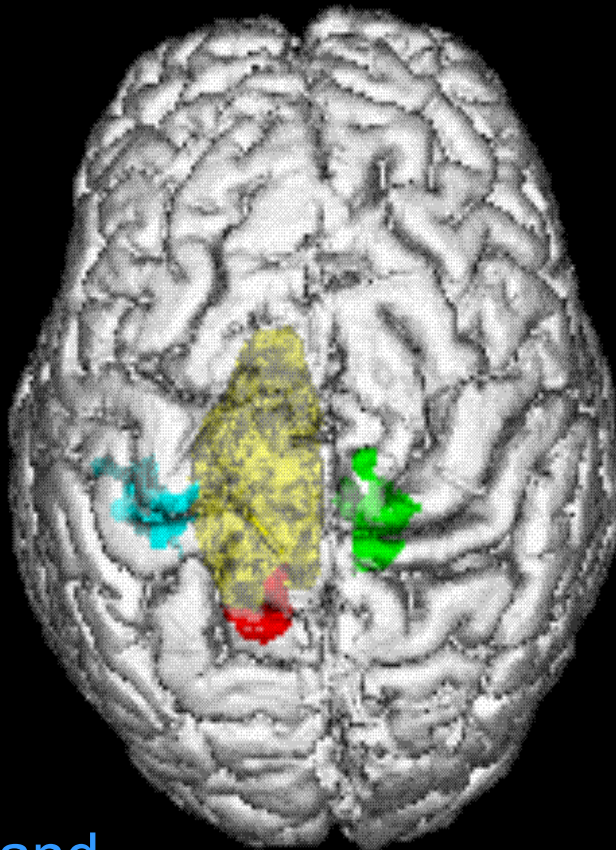

rt hand

rt foot

fM

R

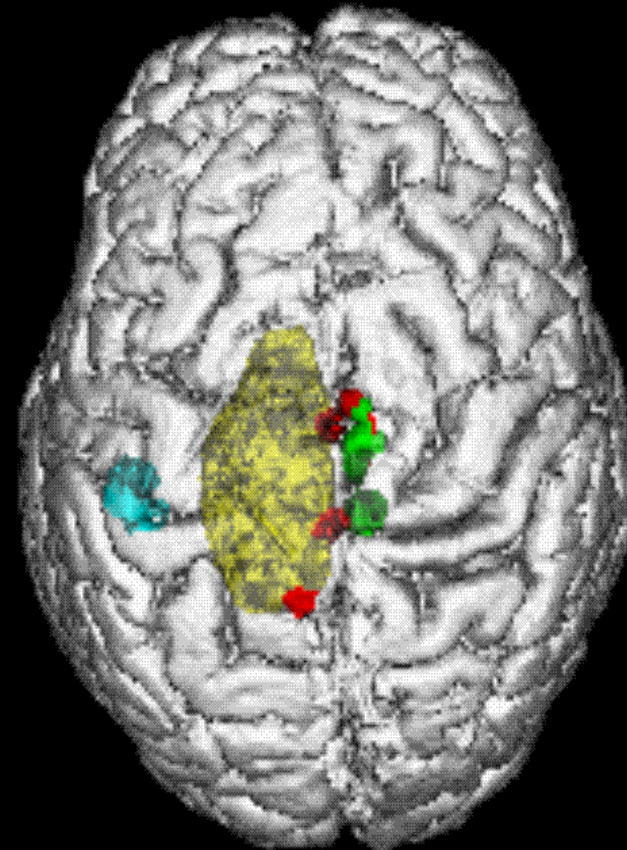

tumor

lt foot

O-15 PET

# Processing Stream with Real Time fMRI

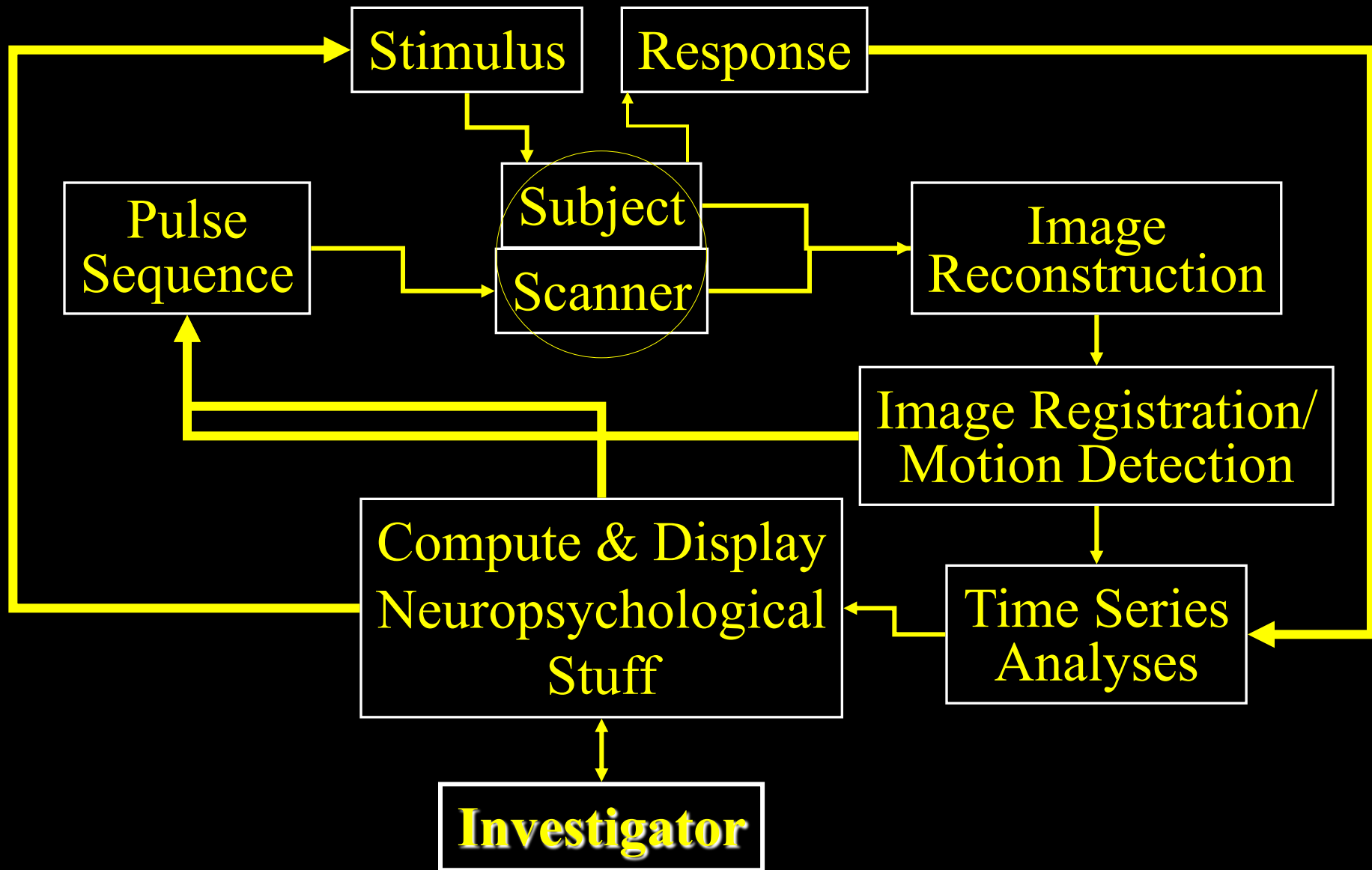

# End of Acquisition

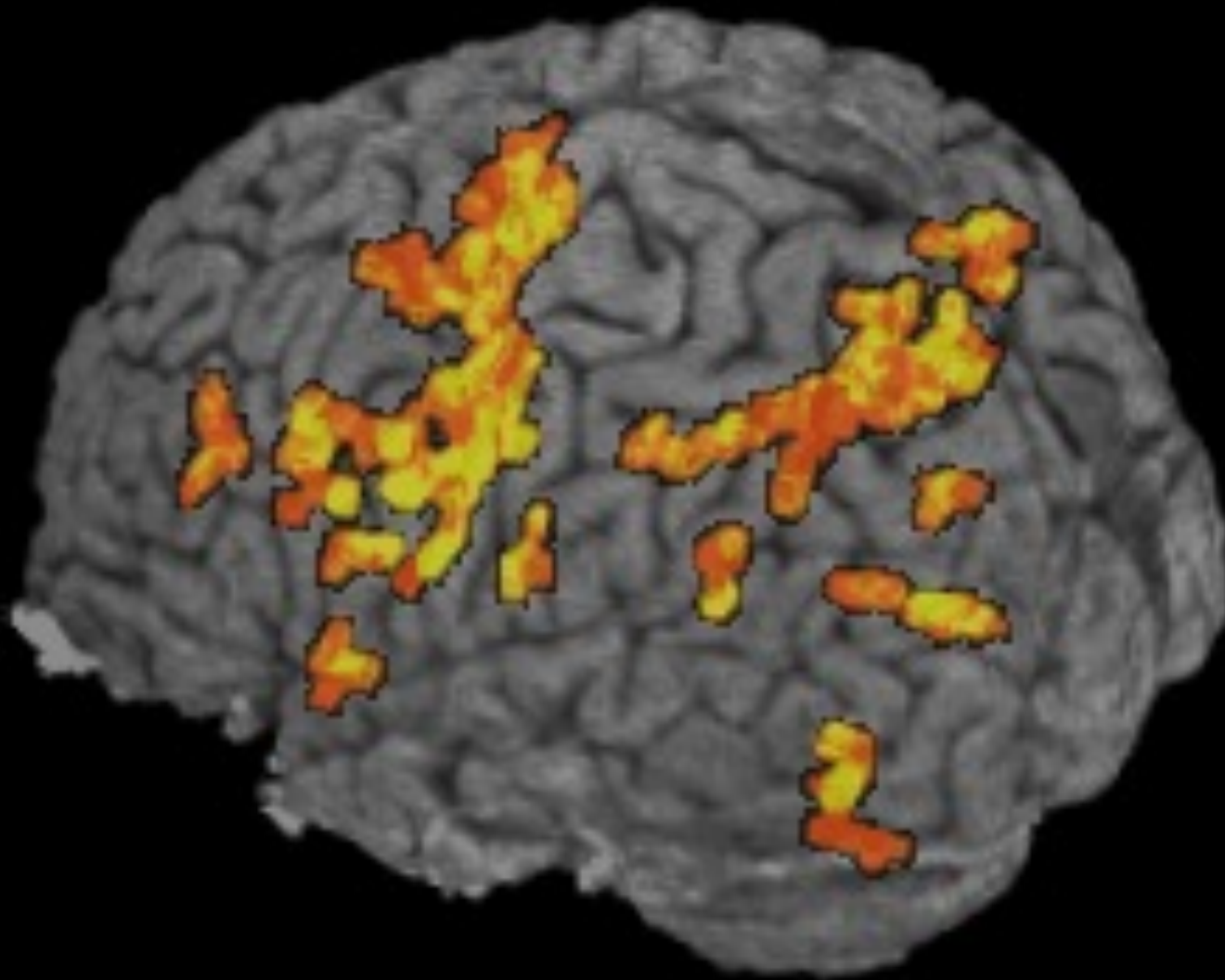

**< 1 s to render**

**Blocked trials:  
20 s on/20 s off  
8 blocks**

**Blocks: 12345678**

**Color shows  
through brain**

**Correlation > 0.45**

**The  
End**



## **Additional Thanks To...**

**Eric Wong, UCSD**

**Robert Savoy, MGH**

**Richard Hoge, MGH**

**Randy Buckner, Wash. U.**

**Ted DeYoe, MCW**

**Sue Courtney, Johns Hopkins U**

**Rasmus Birn, NIH**

**Ziad Saad, NIH**

**Patrick Bellgowan, NIH**

# Functional Imaging Methods / 3T Group

## Staff Scientists:

Sean Marrett

Jerzy Bodurka

## Post Docs:

Rasmus Birn

Patrick Bellgowan

Ziad Saad

## Graduate Students:

Natalia Petridou

## Summer Student:

Dan Kelley

## Program Assistant:

Kay Kuhns



August, 2000