

fMRI Contrast: How Much More Information Can We Obtain?

Peter A. Bandettini, Ph.D.

Unit on Functional Imaging Methods
&
3T Neuroimaging Core Facility

Laboratory of Brain and Cognition
National Institute of Mental Health

BOLD Contrast

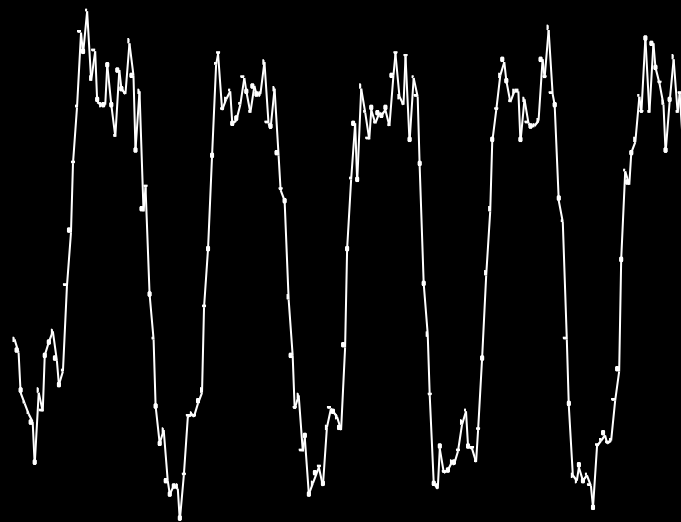
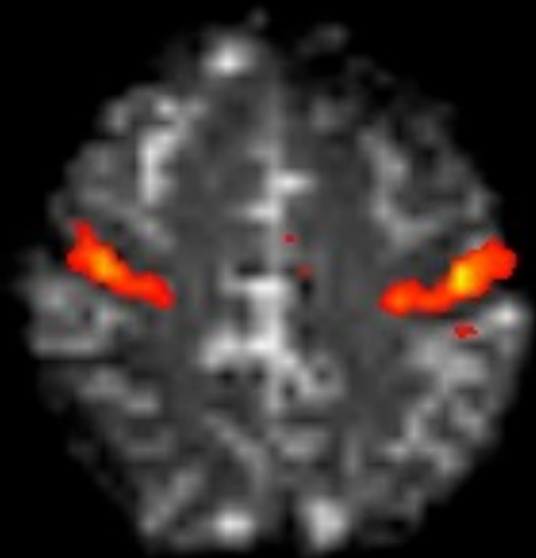

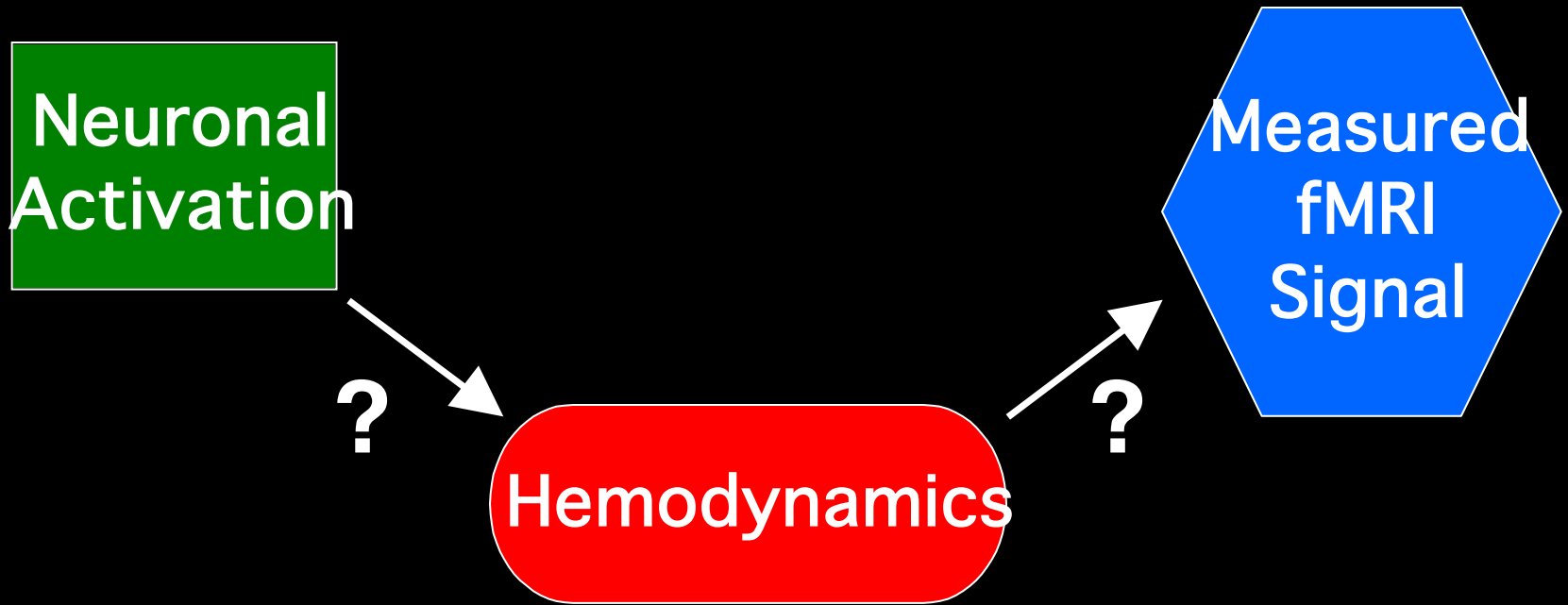

The continuing challenge is to make progressively more precise **neuronal**, **metabolic**, and **hemodynamic** inferences across spatial and temporal scales.

Task
Modulation & Measurement

Pulse Sequence
Modulation

Neuronal
Activation

Measured
fMRI
Signal

?

Hemodynamics

?

Physiologic
Modulation / Measurement

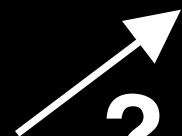

BOLD Contrast Advancements

1991- 2

- TE dependence
- Field Strength Dependence
- Resolution Dependence
- Pulse sequence dependence (T2 and T2*)
- Dynamics: latency and return to baseline
- First BOLD models
- Correlation of BOLD with parametric task manipulation

1992- 3

- Post undershoot
- NMR phase shift observation
- Angio and venogram correlation
- Effects of Physiologic Stress

1993- 4

- Retinotopy
- Cognitive mapping
- Event - related fMRI

1994 - 5

- Parametric task design
- Sub-millimeter resolution fMRI
- Diffusion weighting dependence (IV contribution)

1995 - 6

- Physiologic fluctuations
- Extended duration stimulation effects

1996 - 7

- Pre undershoot
- Flow and BOLD comparisons (dynamics and magnitude)

1997-

8

- Blood volume dynamics
- Simultaneous flow and BOLD acquisition
- Ocular Dominance Column Mapping

1998 - 9

- CMRO₂ Mapping
- Randomized ER-fMRI task design
- Balloon Model
- Baseline Blood Oxygenation Quantitation

1999 - 2000

- Mental Chronometry
- Linearity of BOLD signal change

Task
Modulation & Measurement

Pulse Sequence
Modulation

Neuronal
Activation

Measured
fMRI
Signal

?

Hemodynamics

?

Physiologic
Modulation / Measurement

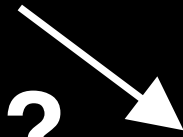

Latency

Magnitude

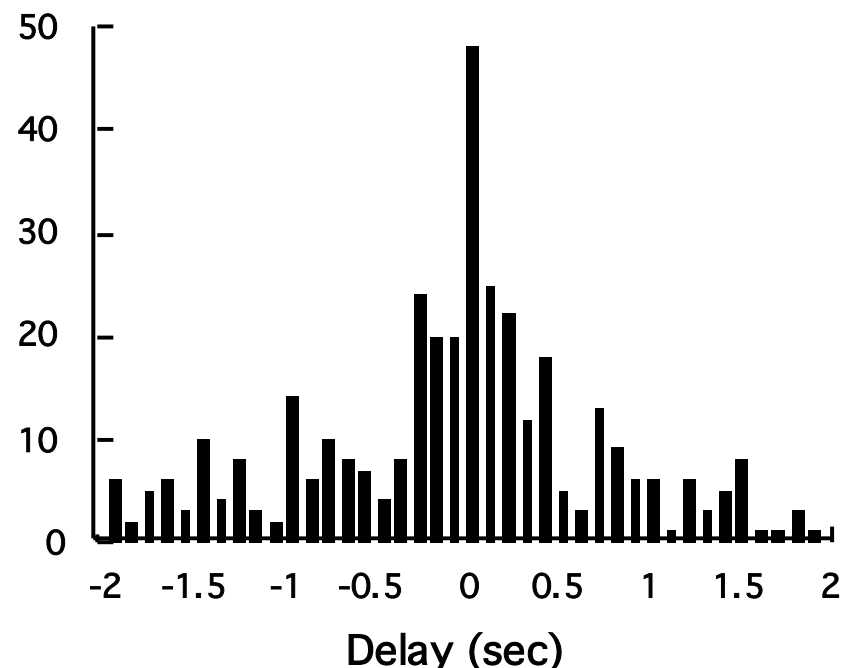
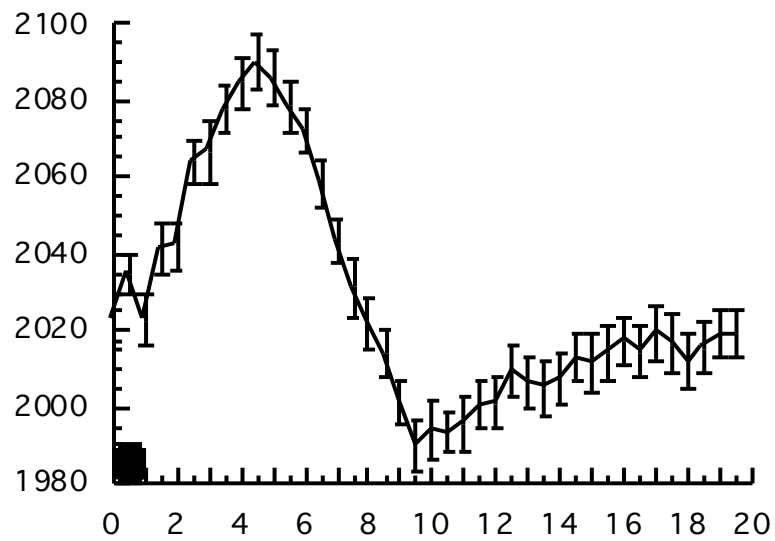
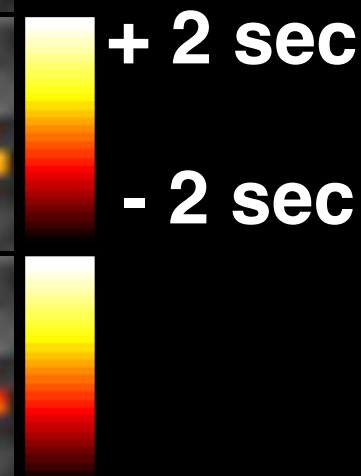
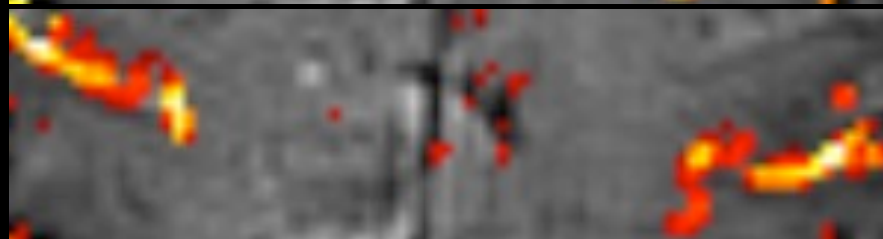
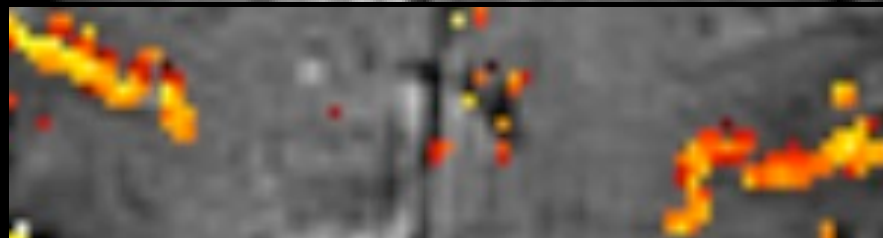

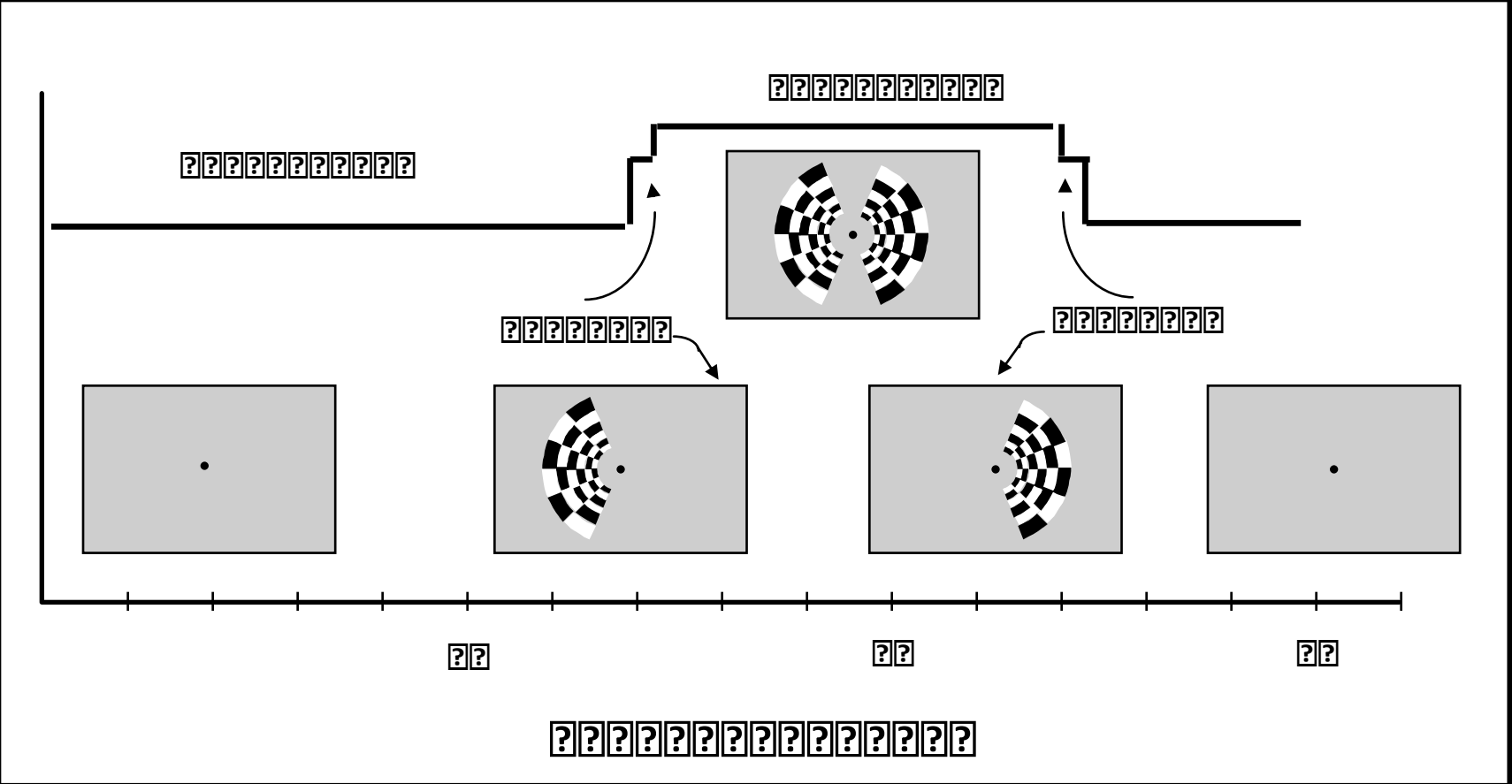

Regions of Interest Used for Hemi-Field Experiment

**Right
Hemisphere**

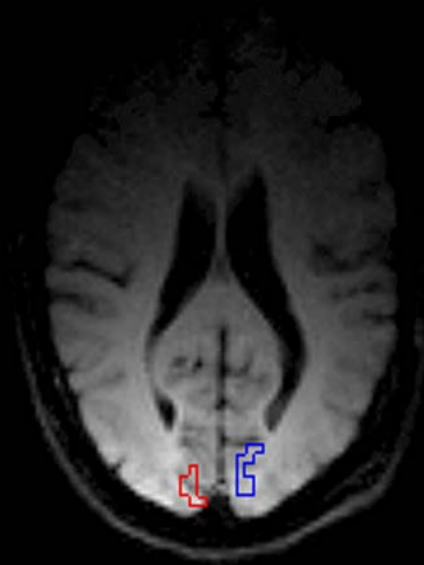

**Left
Hemisphere**

Hemi-field with 500 msec asynchrony

Average of 6 runs Standard Deviations Shown

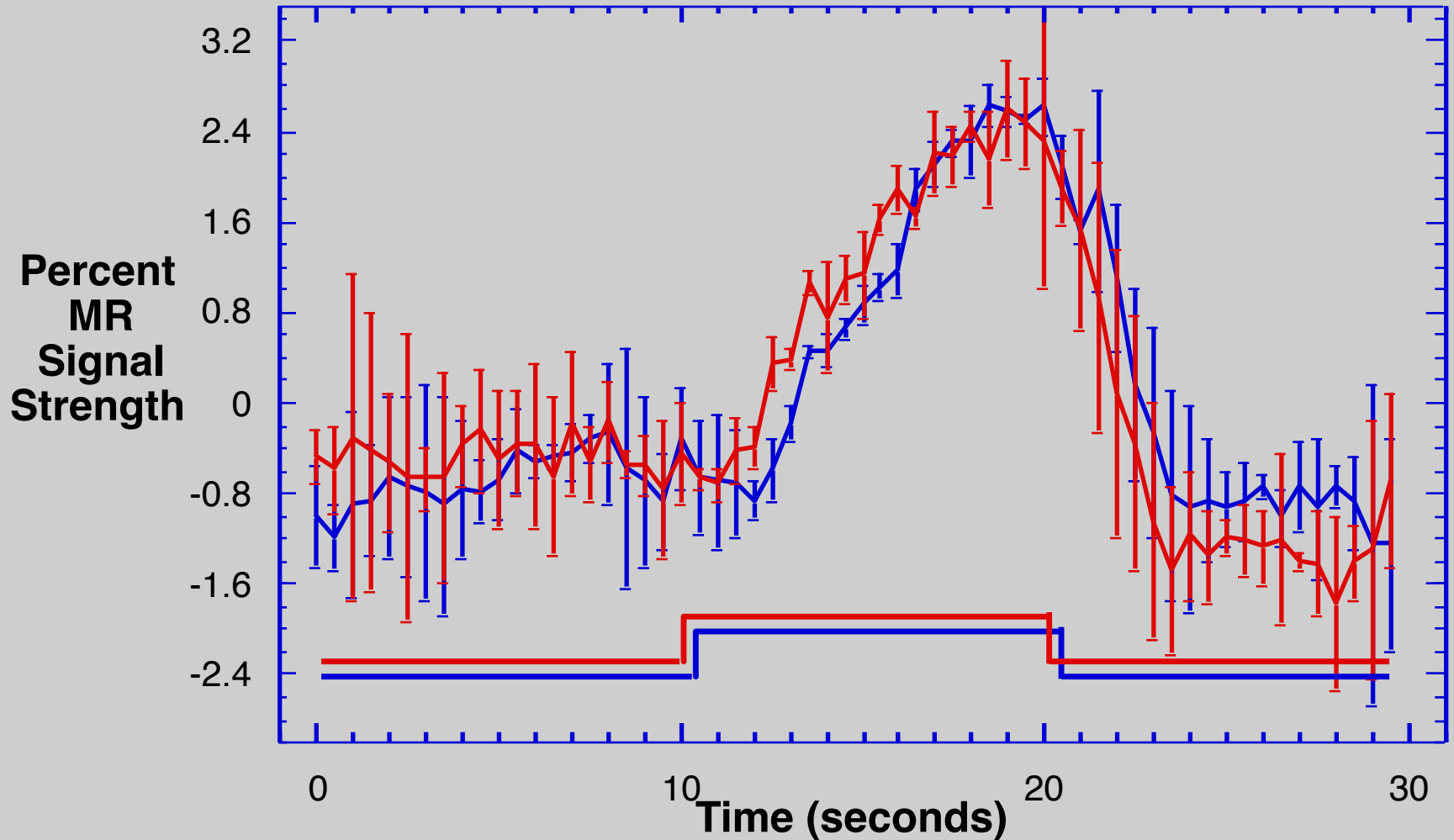

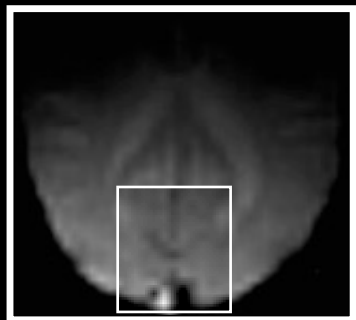

500 ms



500 ms



Right Hemifield

Left Hemifield

+ 2.5 s

0 s

- 2.5 s

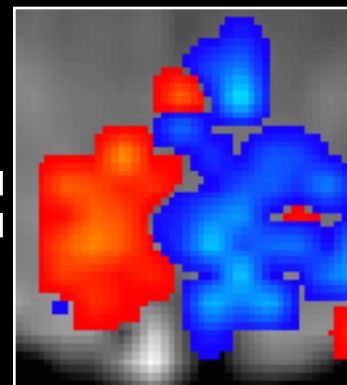
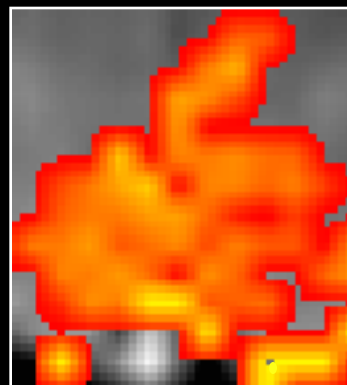
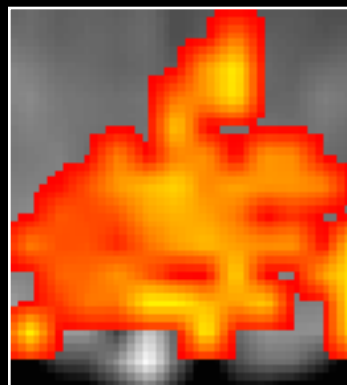

Motor Cortex

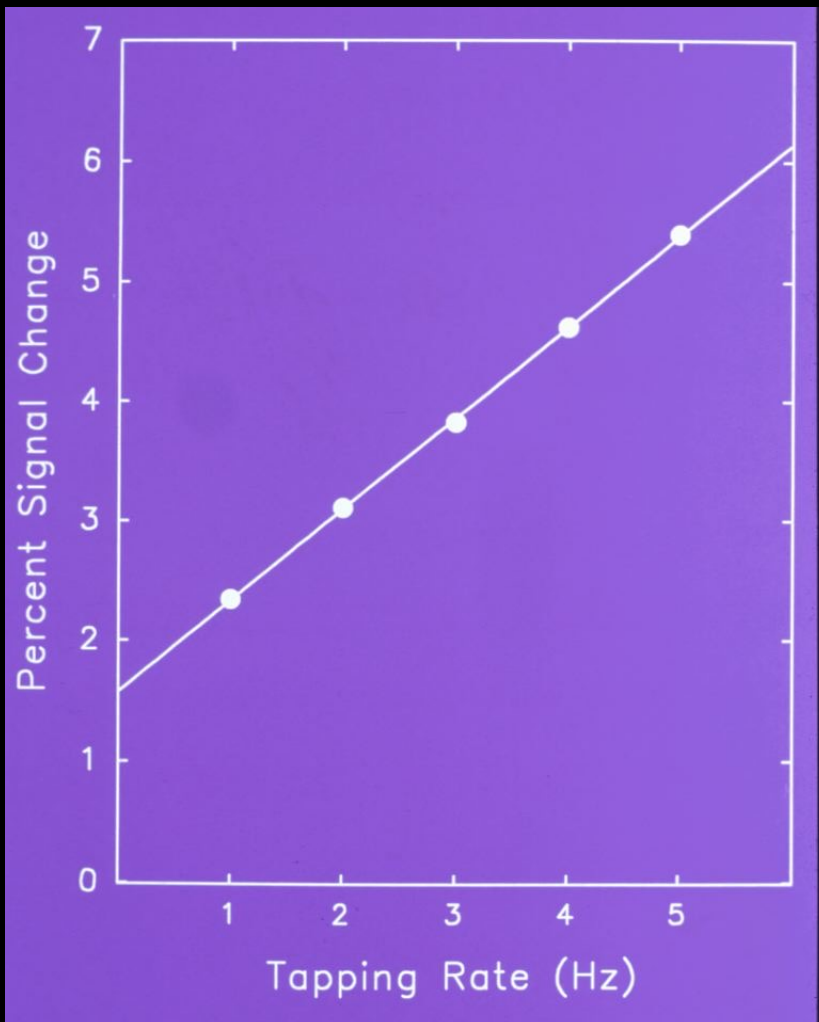

Auditory Cortex

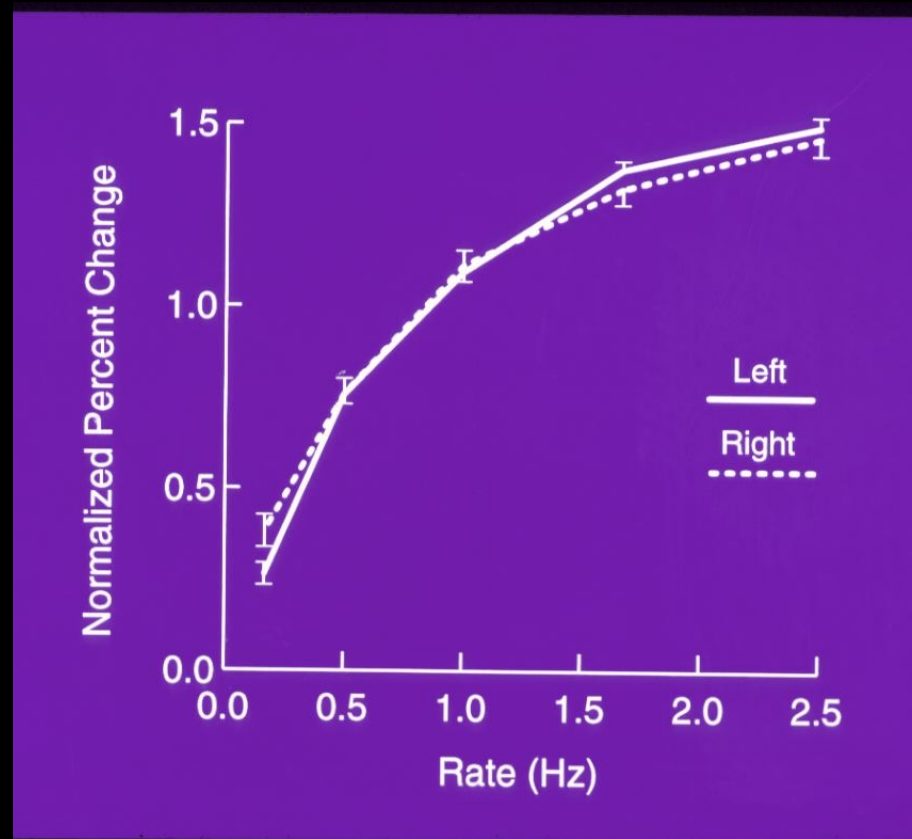

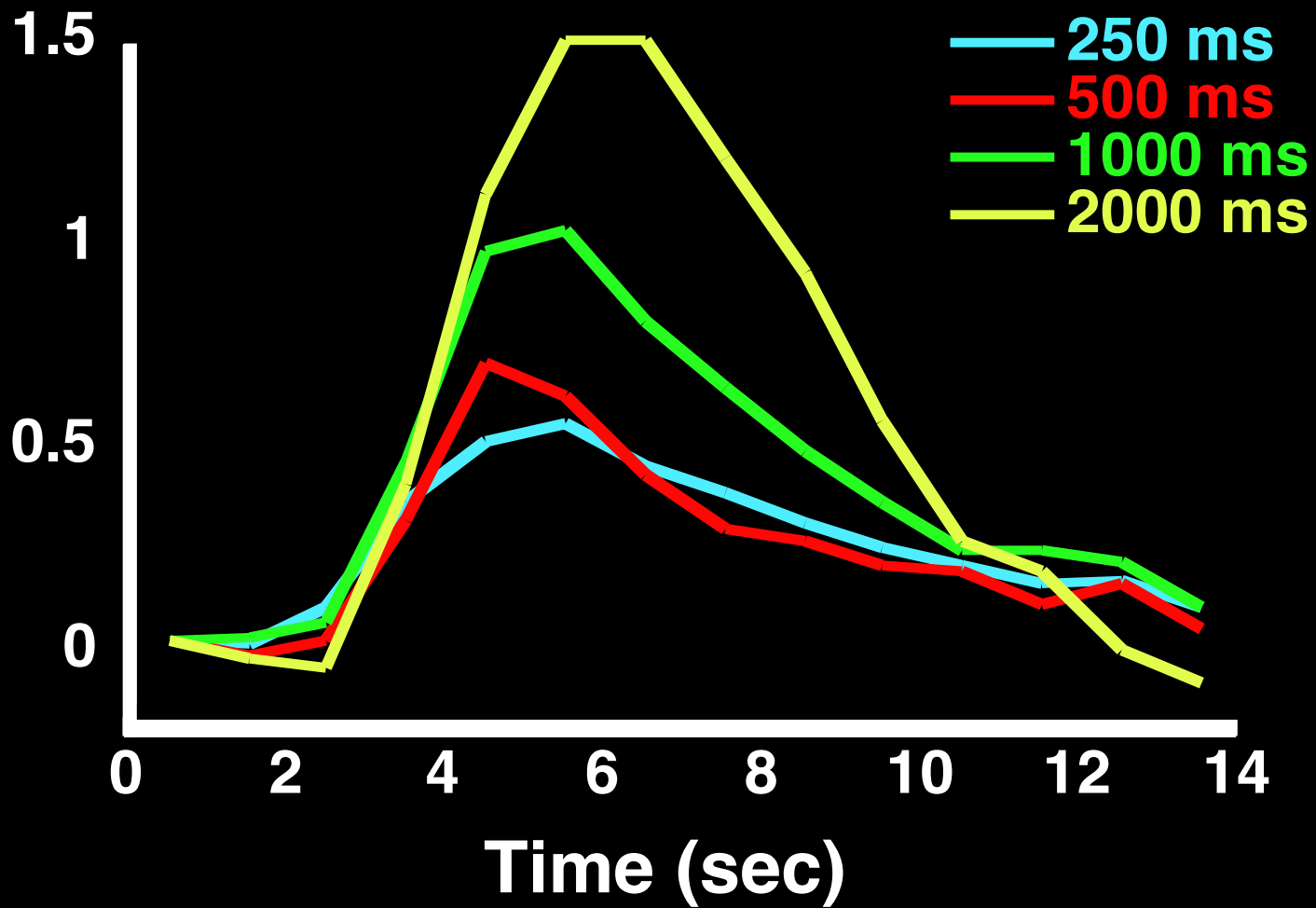

Methods

Stimulus Duration (SD)



16 s



20 s

??????

?????

SD = 250 ms

SD = 500 ms

SD = 500 ms

SD = 1000 ms

SD = 1000 ms

SD = 2000 ms

SD = 2000 ms

SD = 4000 ms

Blocked Trial

??

Observed response

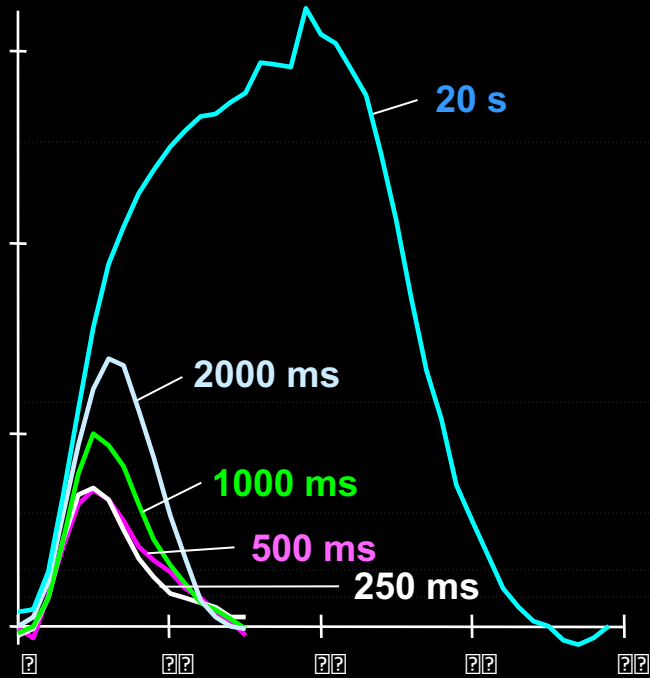

Linear response

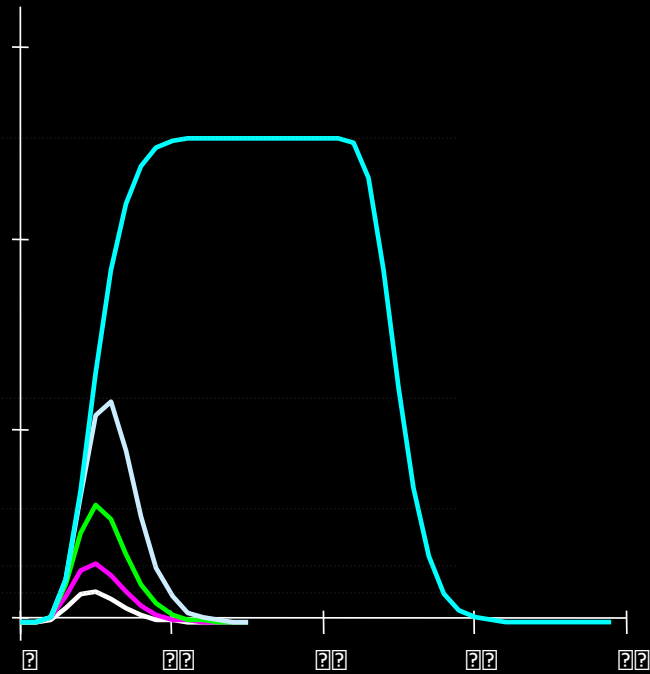

Short duration stimuli produce larger responses than expected

??

????????????????

- Amplitude of Response

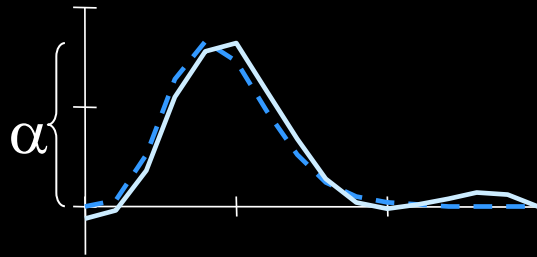

Fit ideal (linear) to response

- Area under response / Stimulus Duration

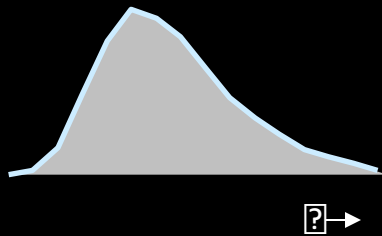

Output Area / Input Area

????????????

Visual



Motor



Magnitude

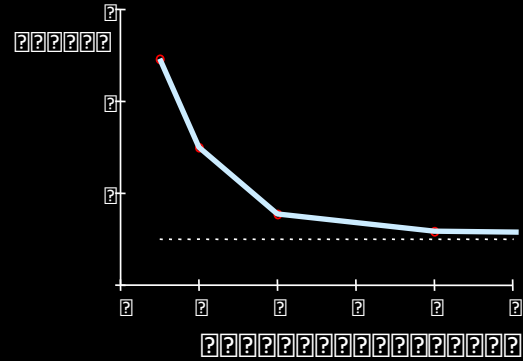
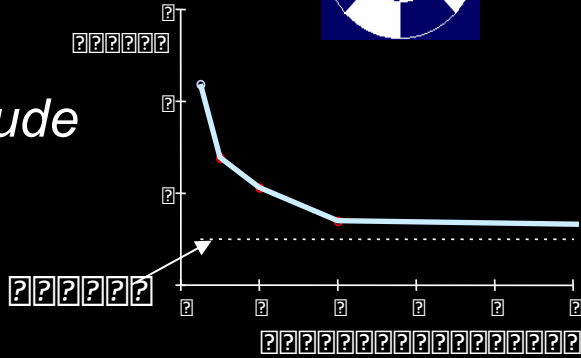

Area

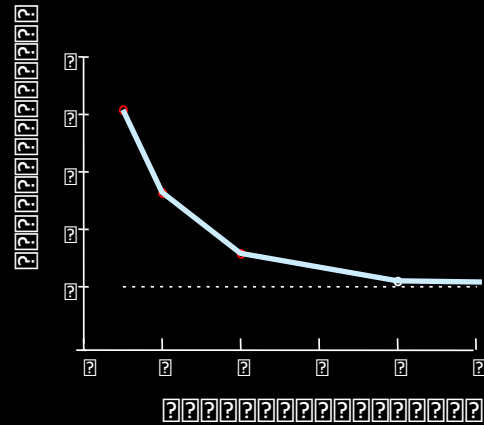
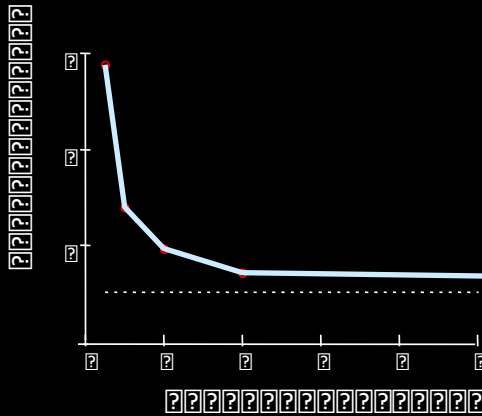

????????????????????????????????

- Area under nonlinearity curve

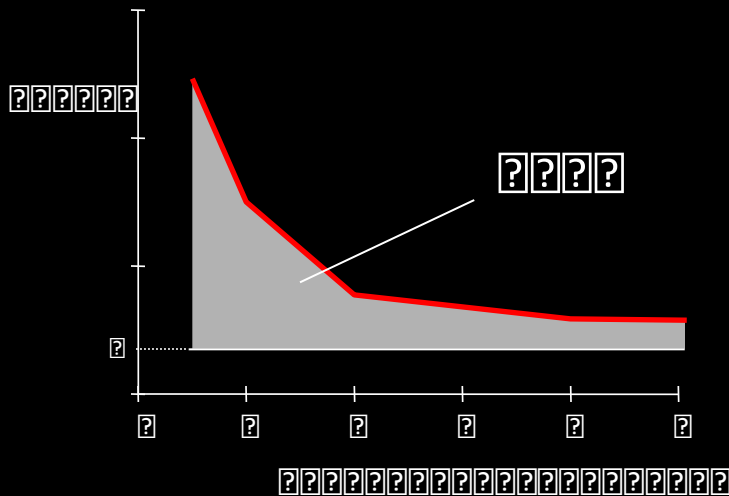

- Slope of nonlinearity curve

????????????????????????????????

?? ? ? ? ? ? ? ? ? ? ? ? ? ? ? ? ? ? ?

Nonlinearity

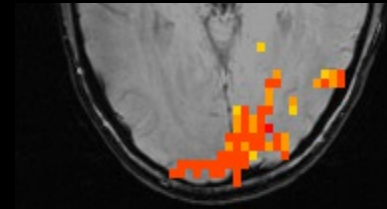
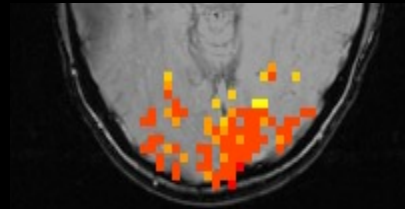
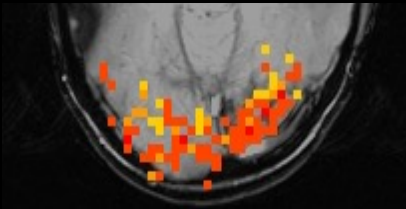

Magnitude

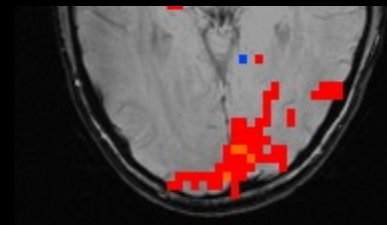
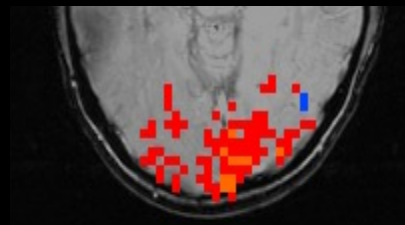
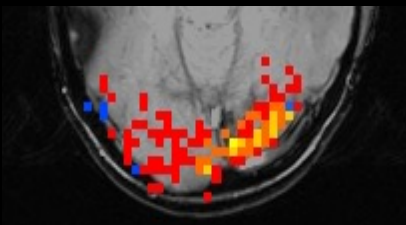

Latency

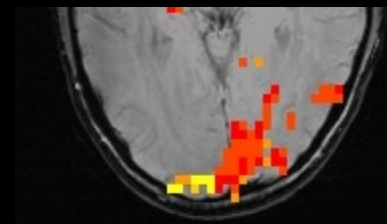
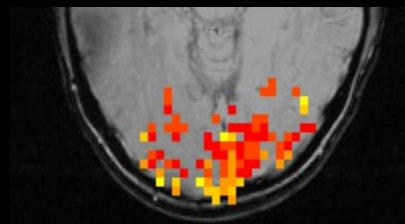
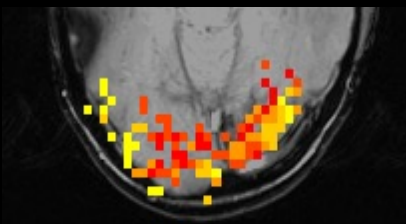

????????????????????????????????

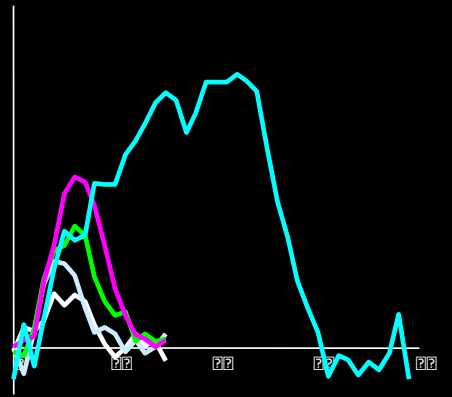
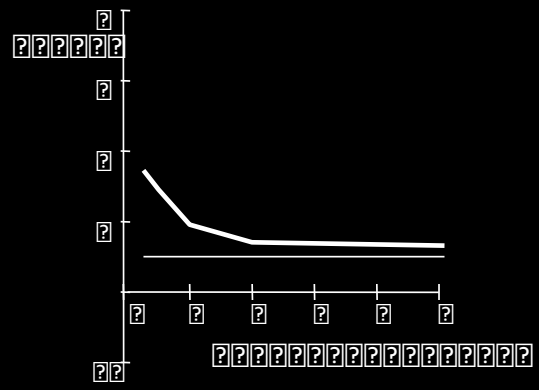
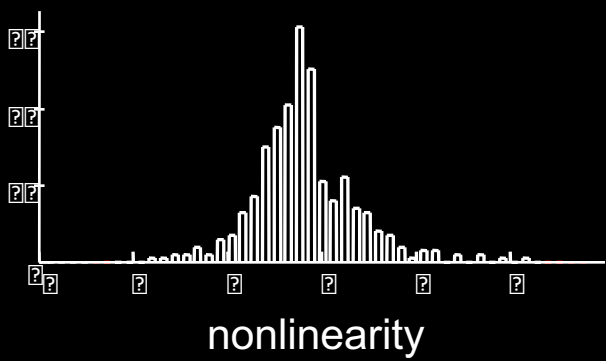
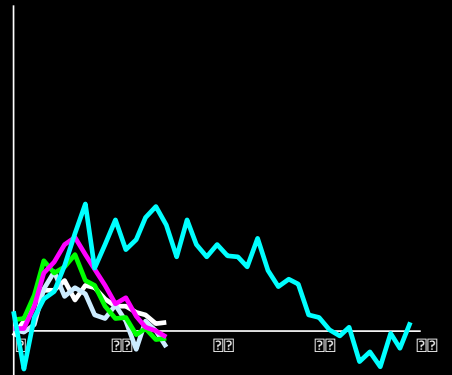
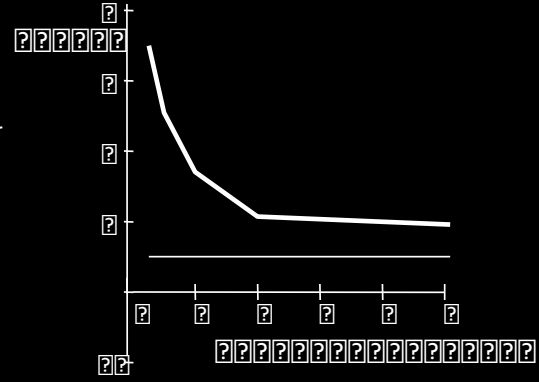
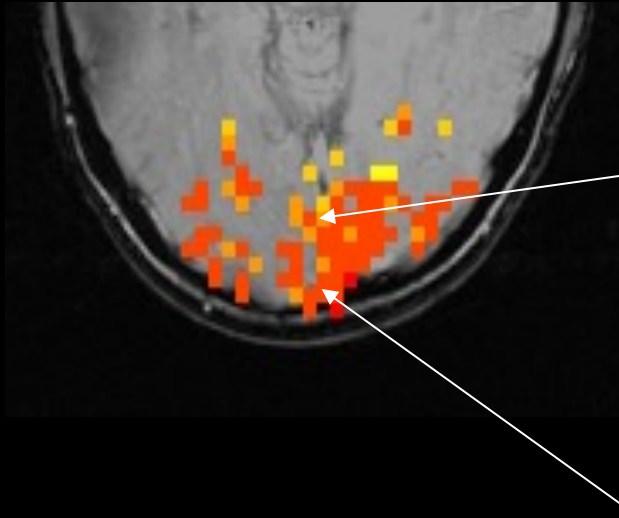

????????????????????

Nonlinearity

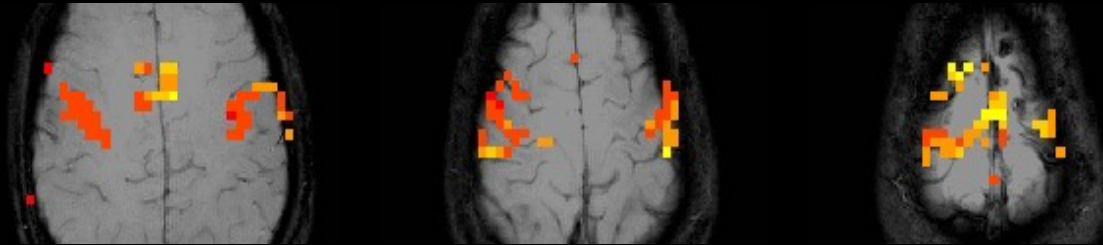

Magnitude

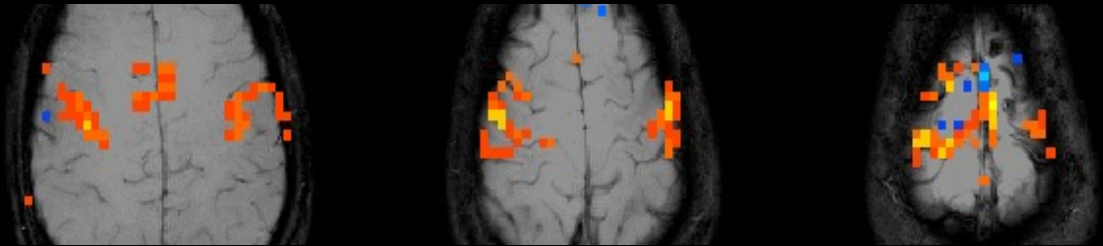

Latency

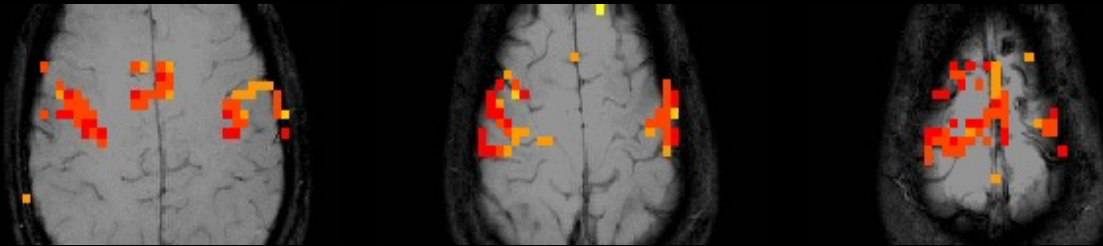

????????????????????

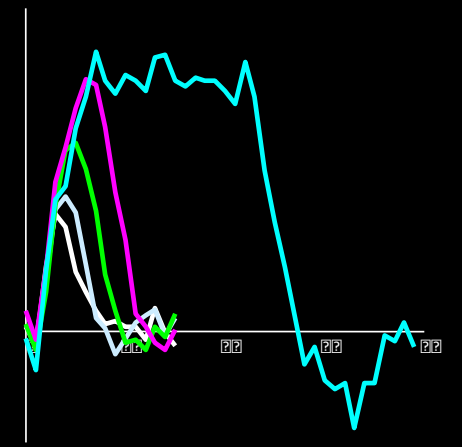
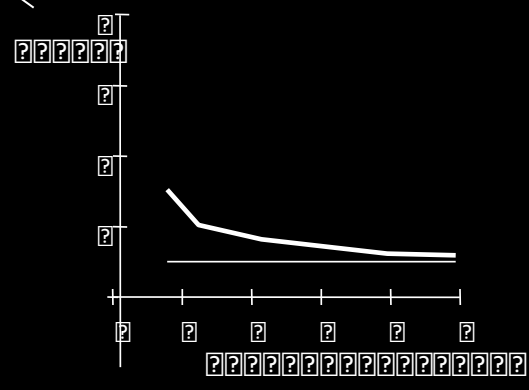
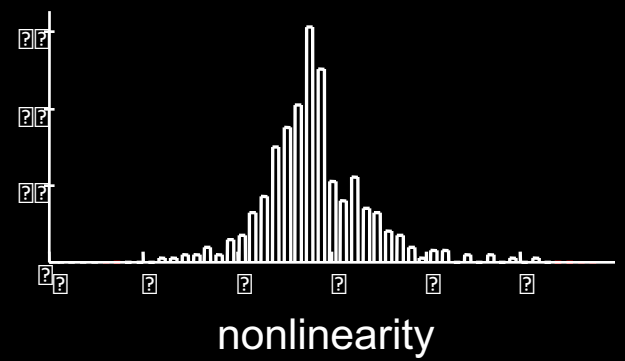
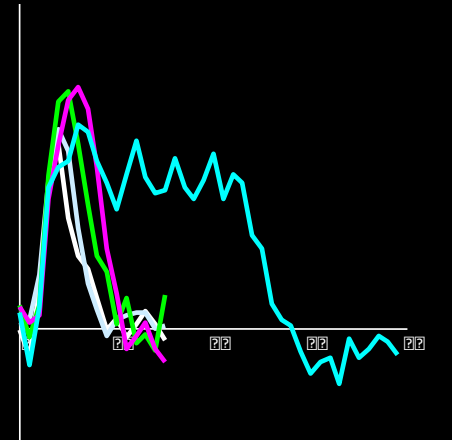
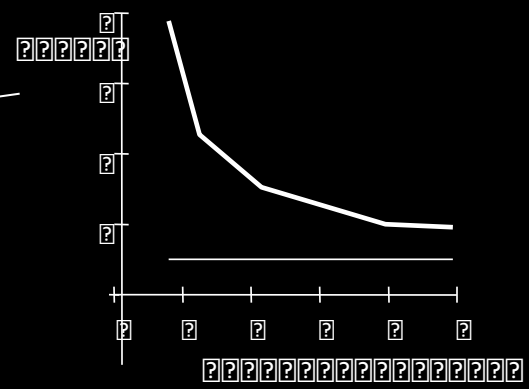
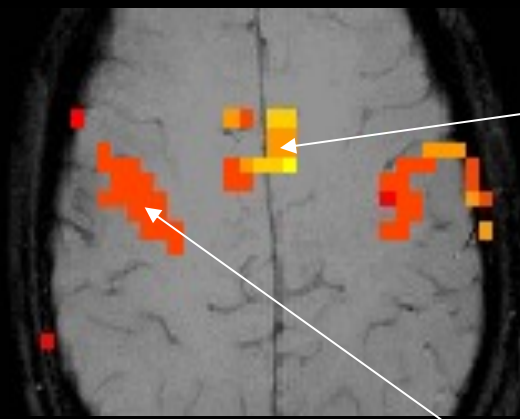

?? ? ? ? ? ? ? ? ? ? ? ? ? ? ?

Visual task

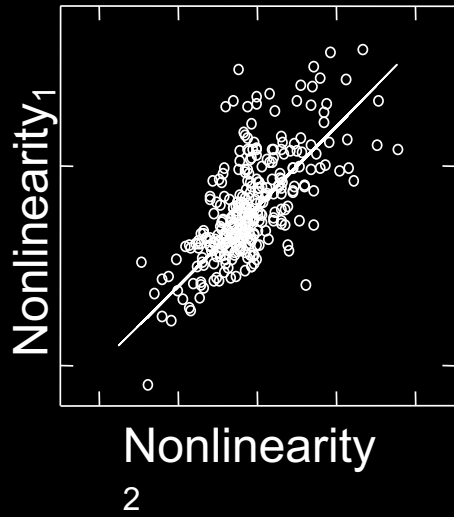

Motor task

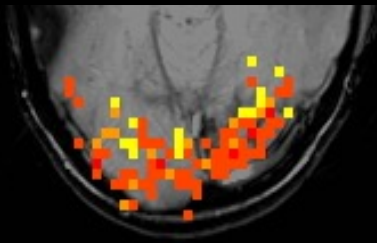
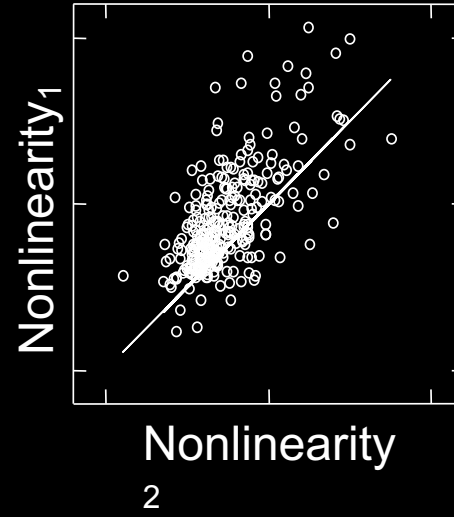

Experiment 1

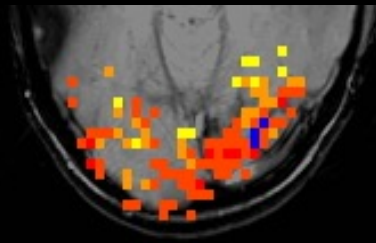

Experiment 2

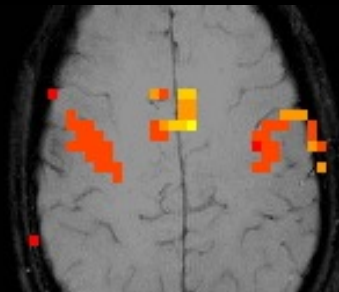

Experiment 1

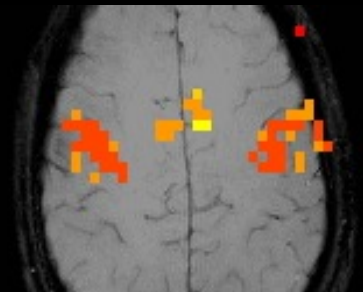

Experiment 2

Conclusions

- Responses to short duration stimuli are larger than predicted from a linear system
- Spatial variation in this nonlinear relationship is seen
- The variation in nonlinearity is not significantly correlated with magnitude or latency

Task
Modulation & Measurement

Pulse Sequence
Modulation

Neuronal
Activation

Measured
fMRI
Signal

?

Hemodynamics

?

Physiologic
Modulation / Measurement

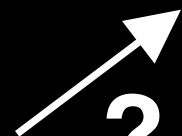
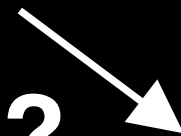

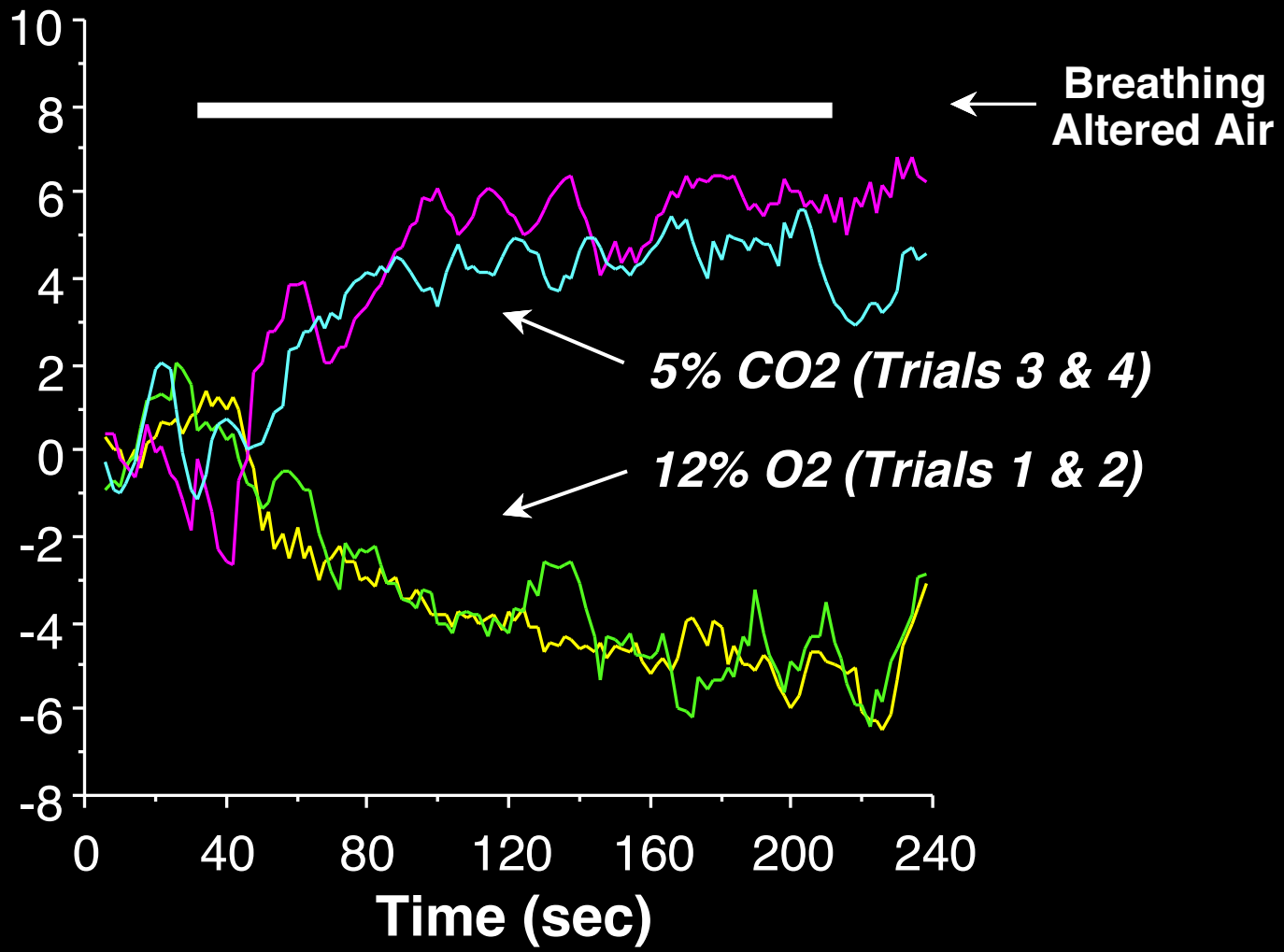

Anatomical

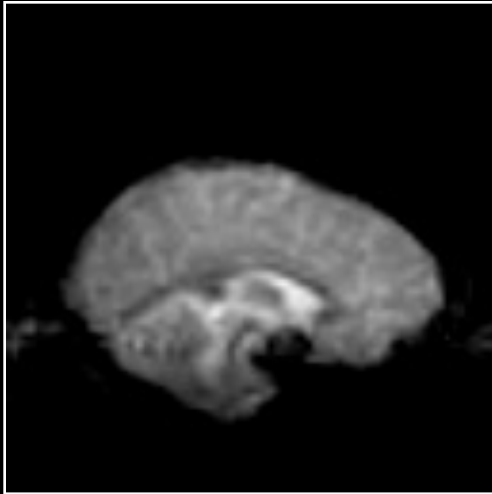

**Finger
Movement**

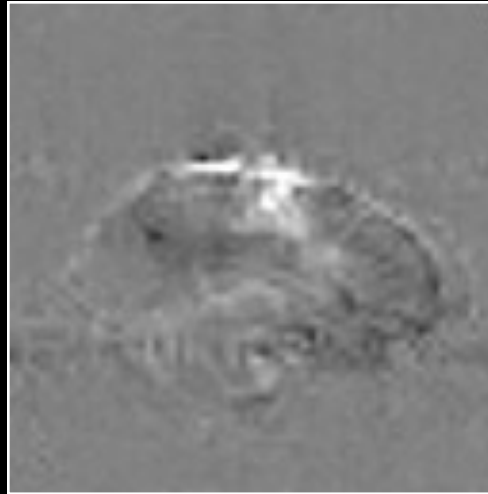

12% O₂

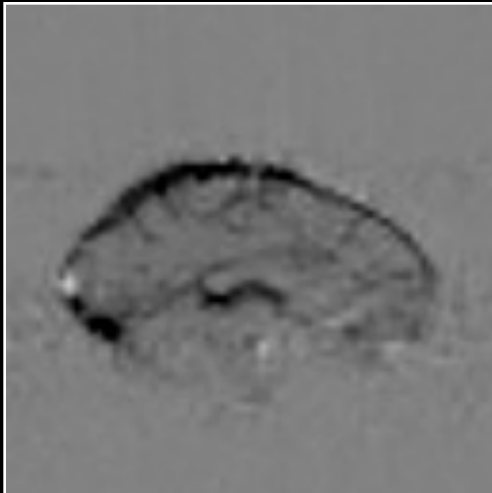

5% CO₂

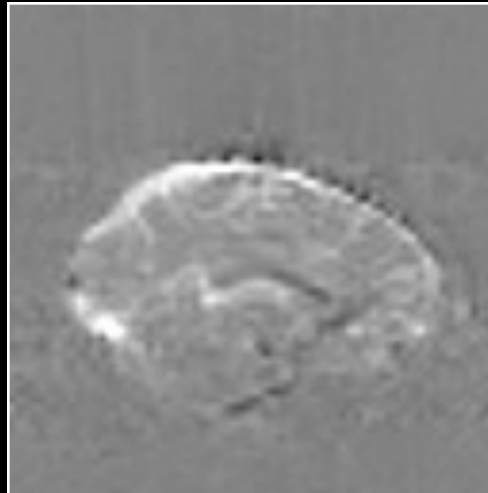

Resting State Blood Volume Weighting

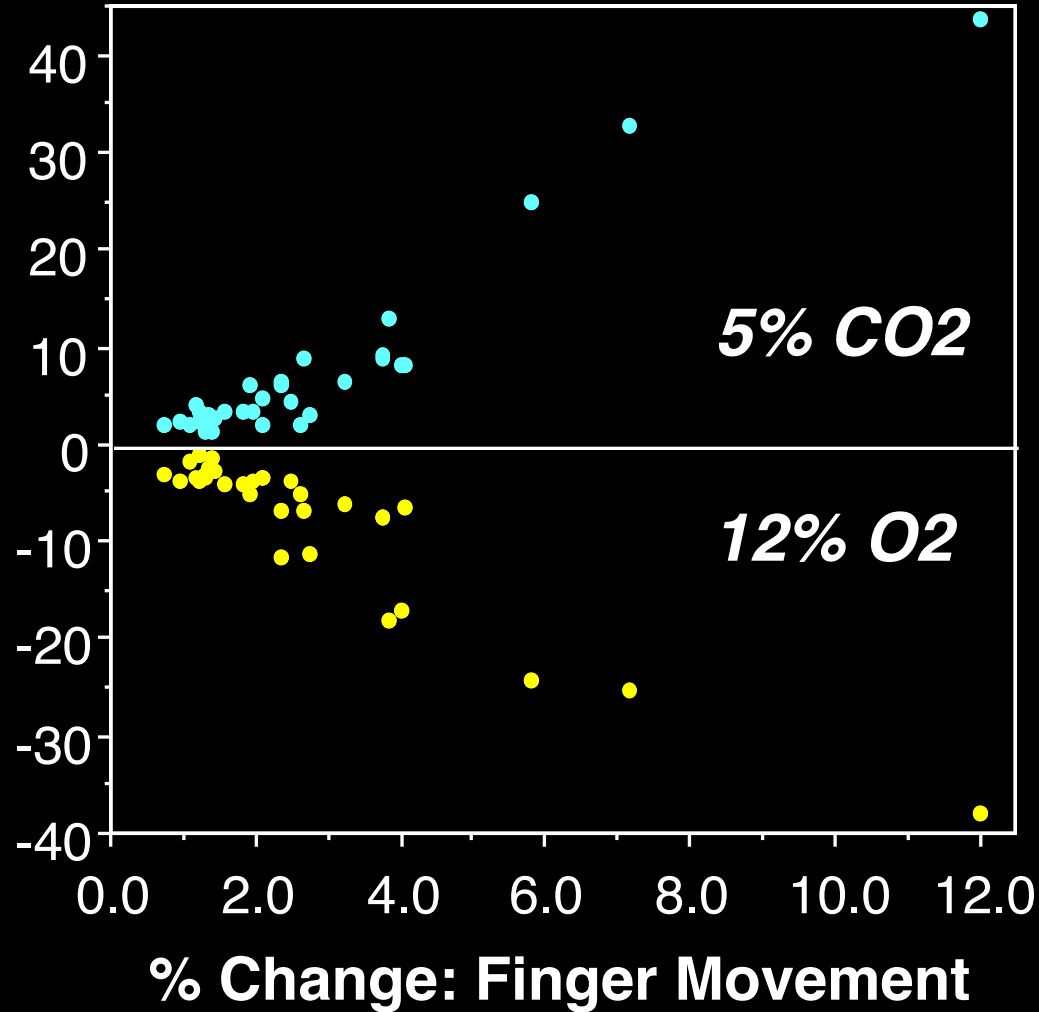

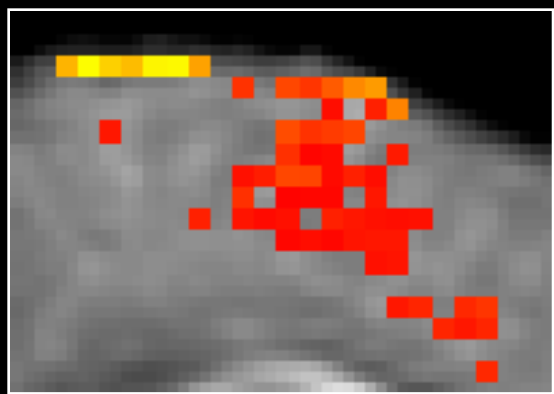

?

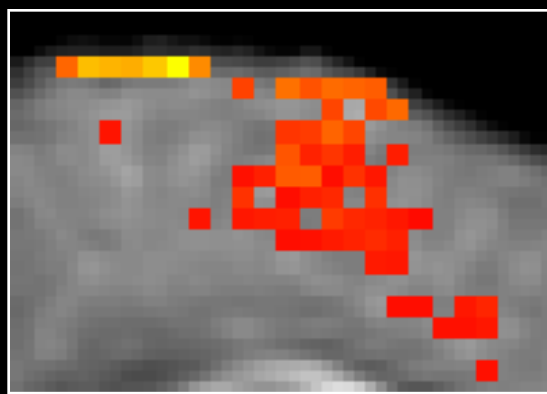

?

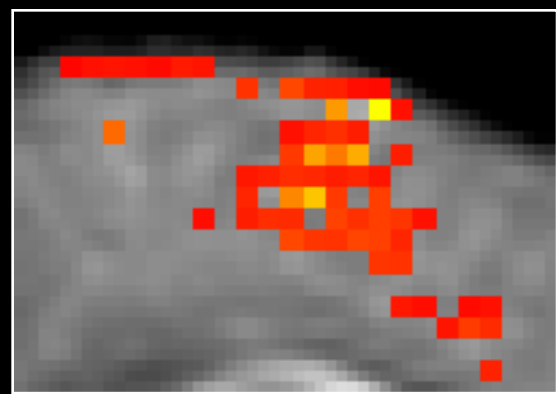

Task
Modulation & Measurement

Pulse Sequence
Modulation

Neuronal
Activation

Measured
fMRI
Signal

?

Hemodynamics

?

Physiologic
Modulation / Measurement

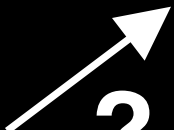

Activation-induced MR Signal Change Mechanisms

T1
Inflow

T2

T2*

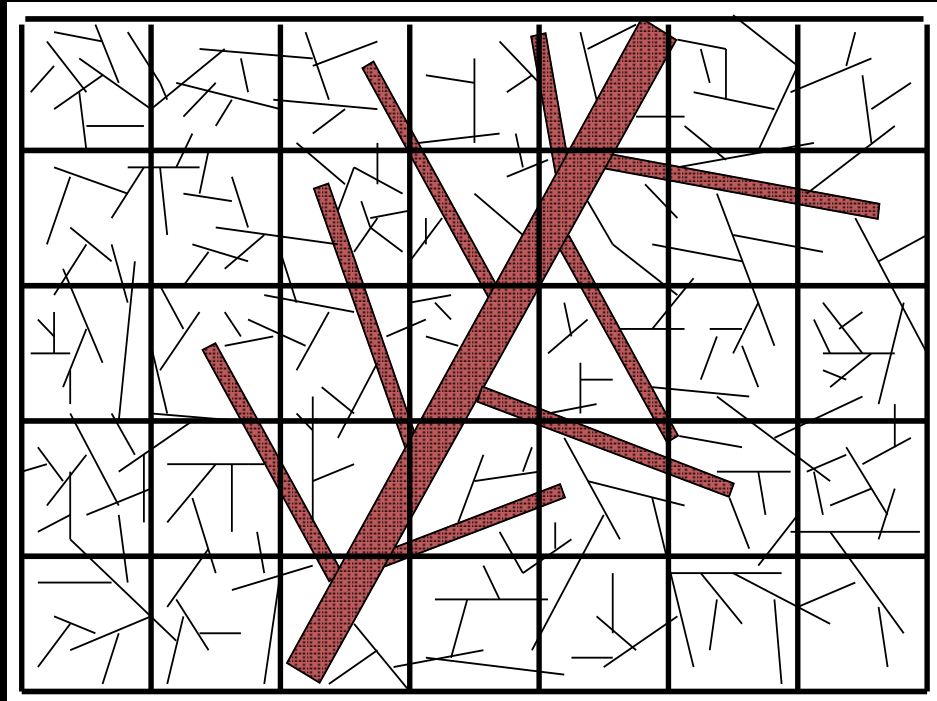

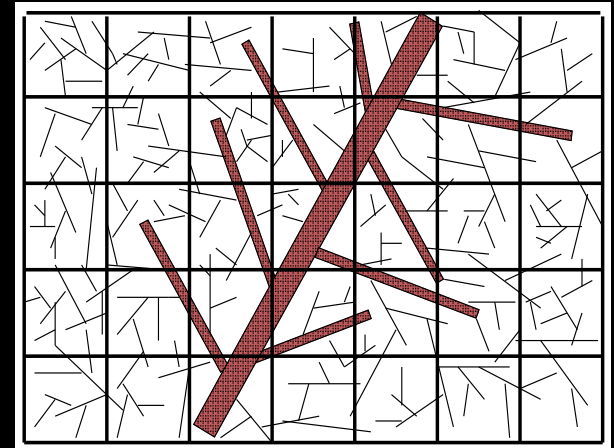

Fractional Signal Change

2.5 mm²

1.25 mm²

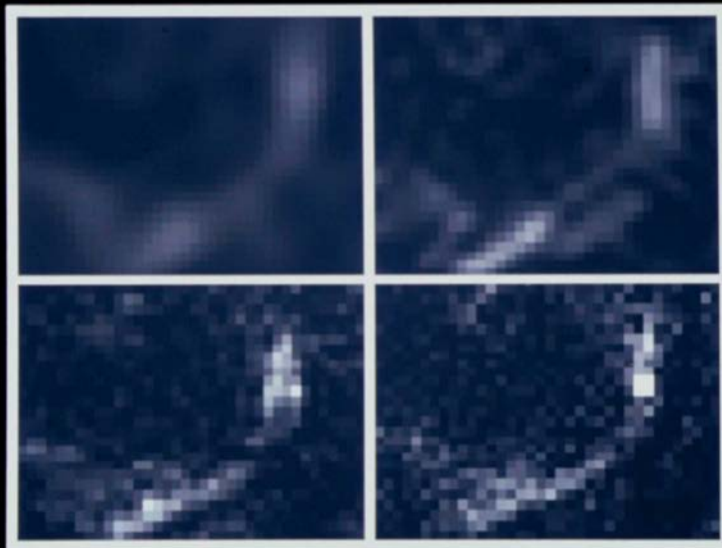

0.83 mm²

0.62 mm²

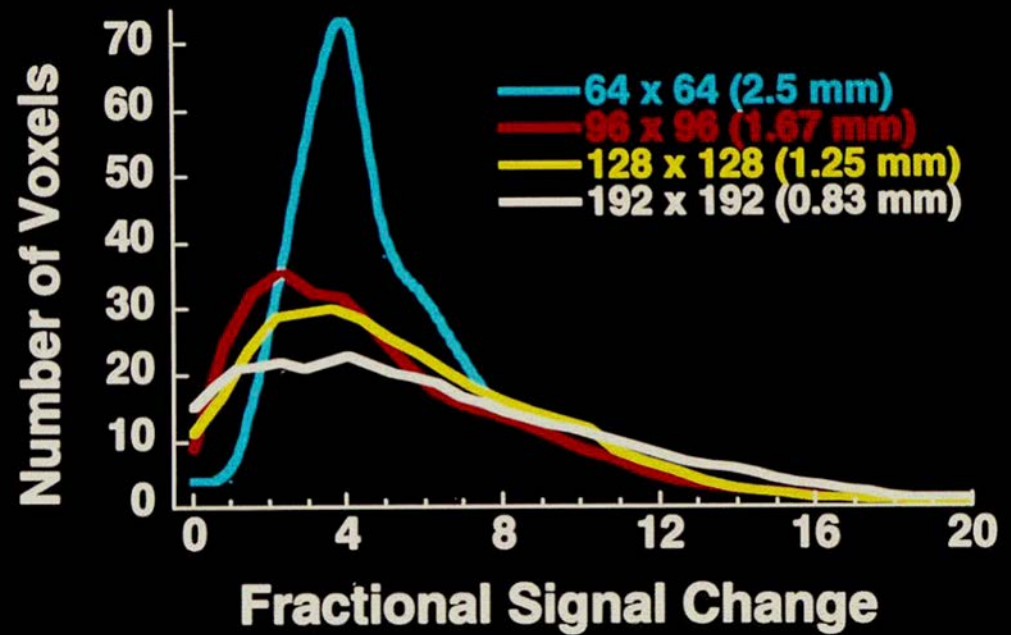

T1 - weighted



T2* weighted



**T1 and T2*
weighted**



Perfusion

BOLD

Rest

Activation

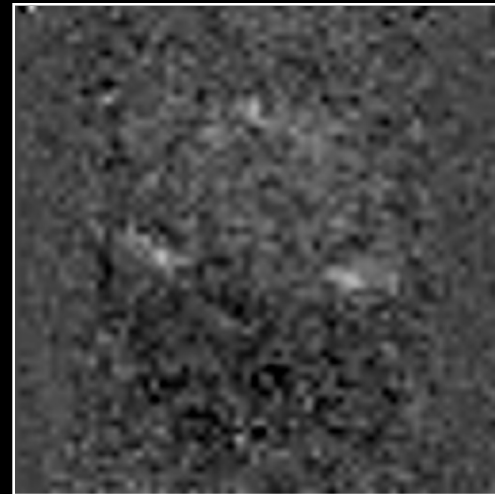
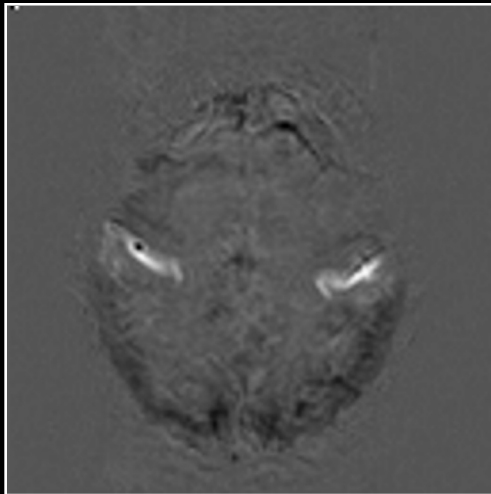
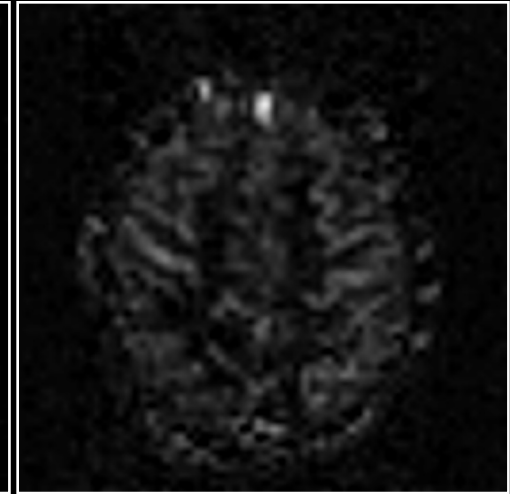
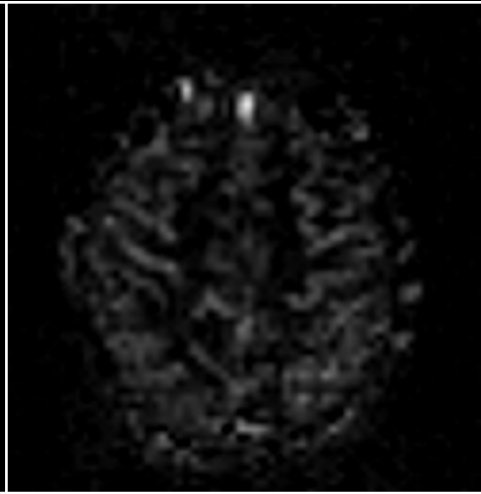
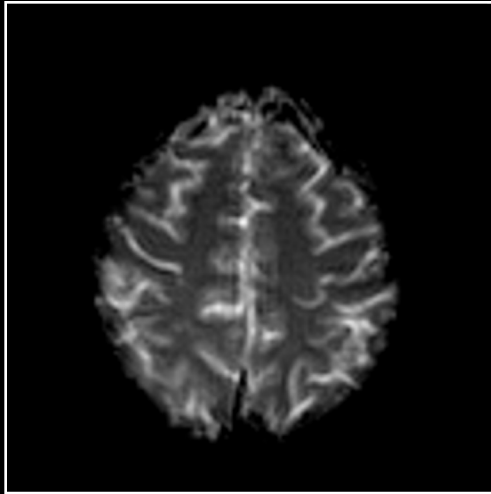

Anatomy



BOLD



Perfusion



Velocity Nulling at 1.5T

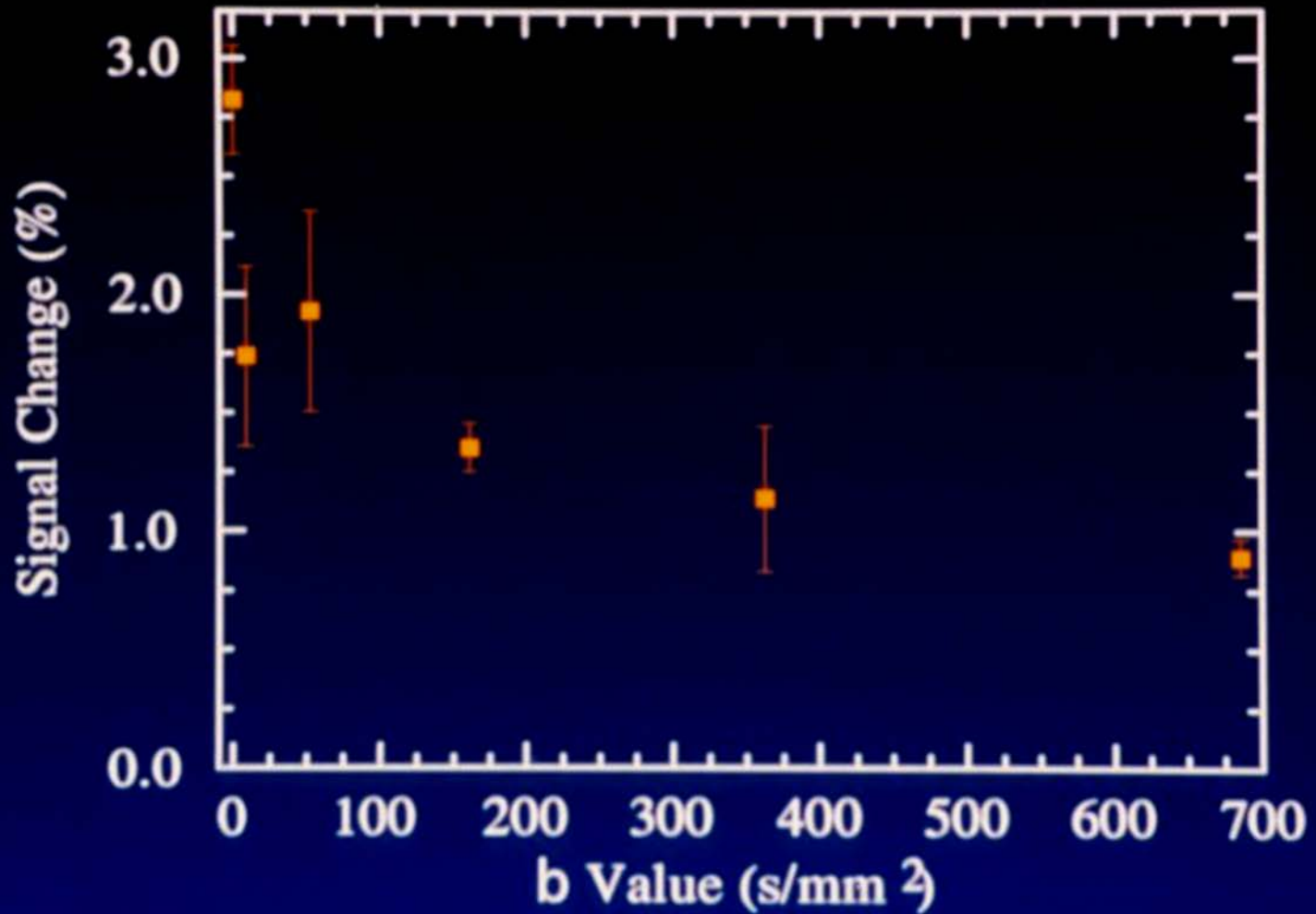

$b = 0$

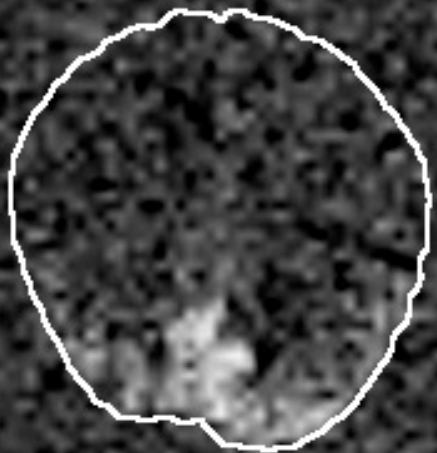

$b = 10$



$b = 50$

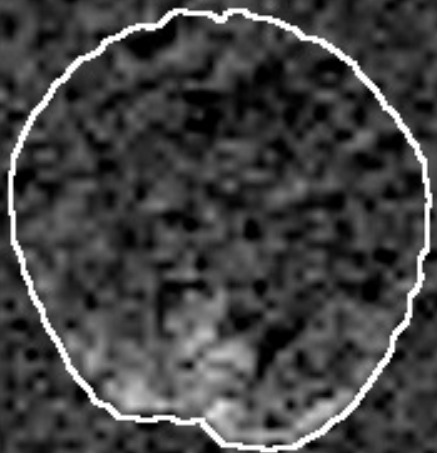

$b = 160$





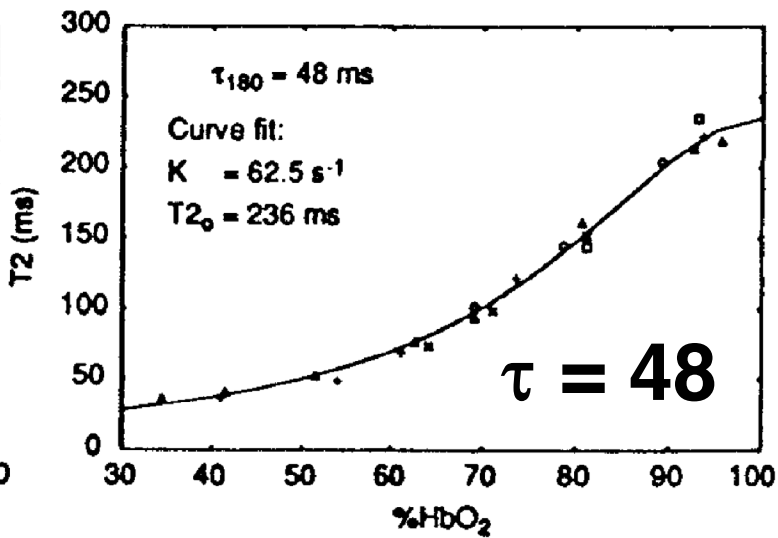
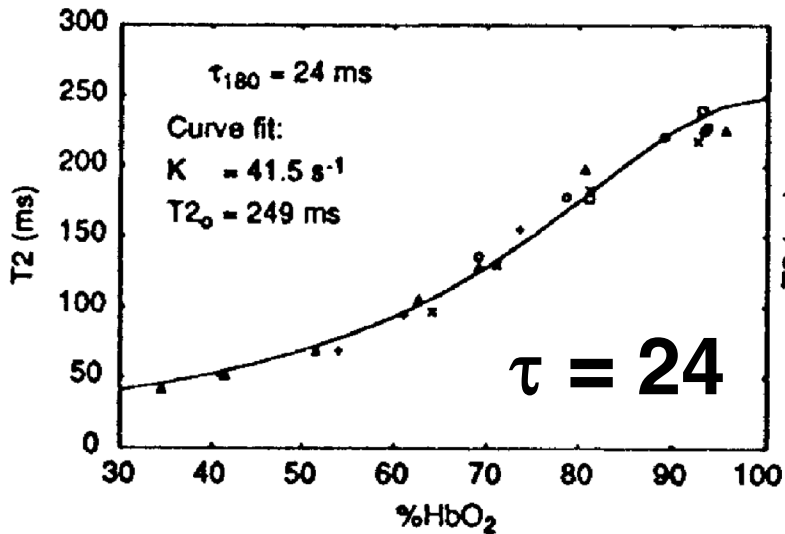
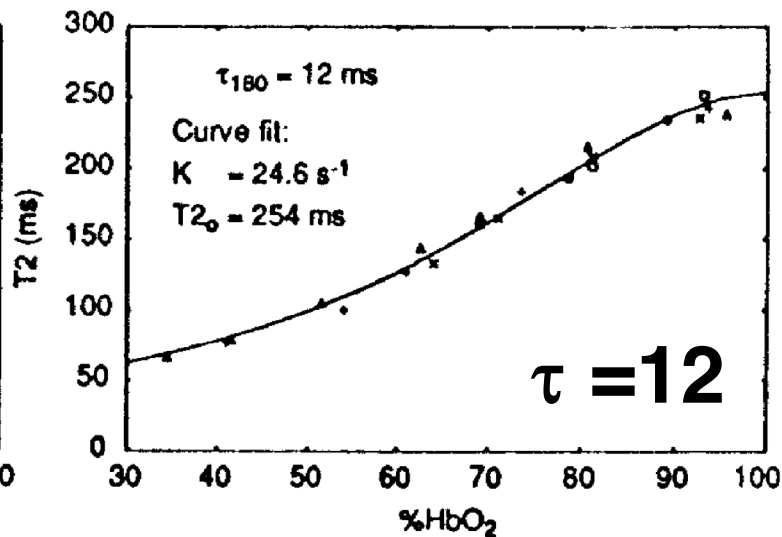
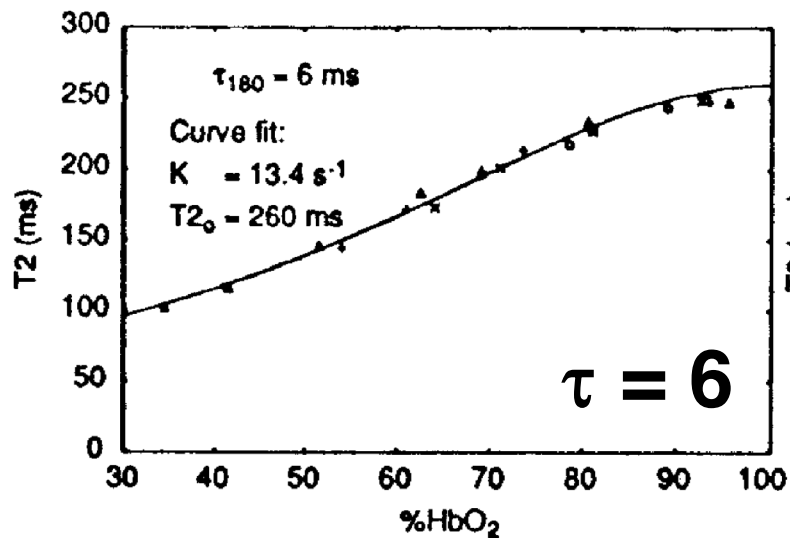

$D = 1 \mu\text{m}^2 / \text{ms} \rightarrow 2.5 \mu\text{m}^2 / \text{ms}$

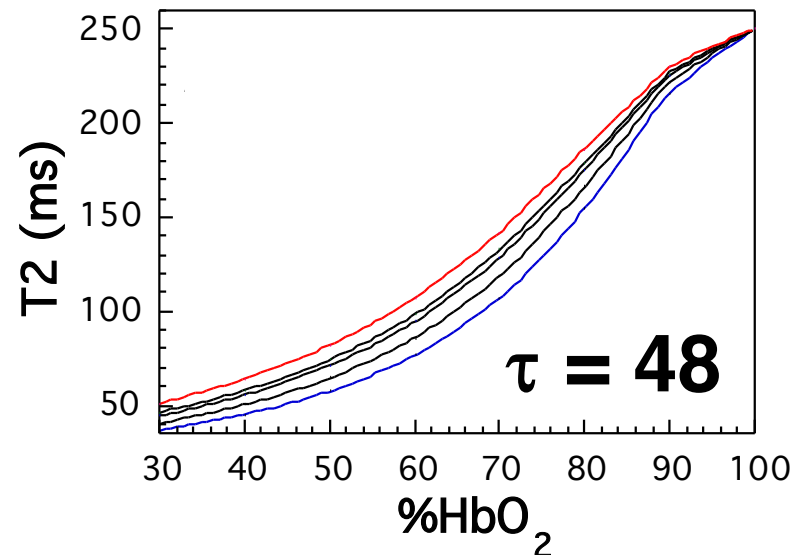
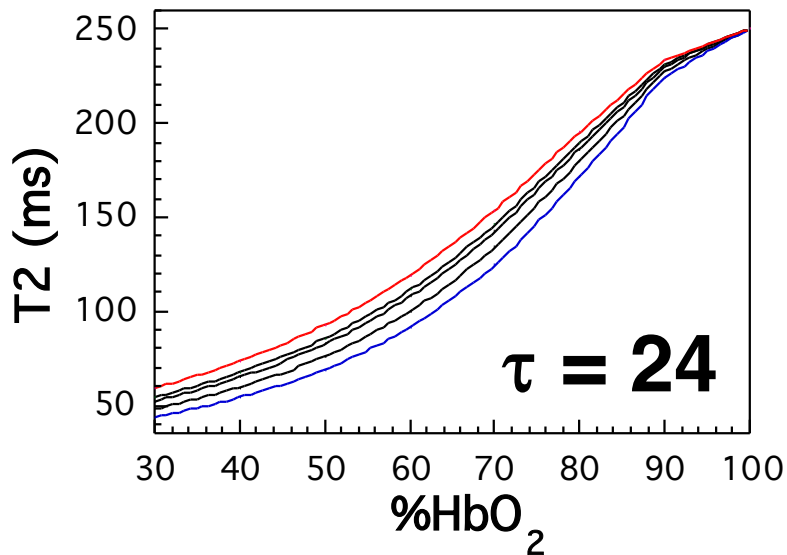
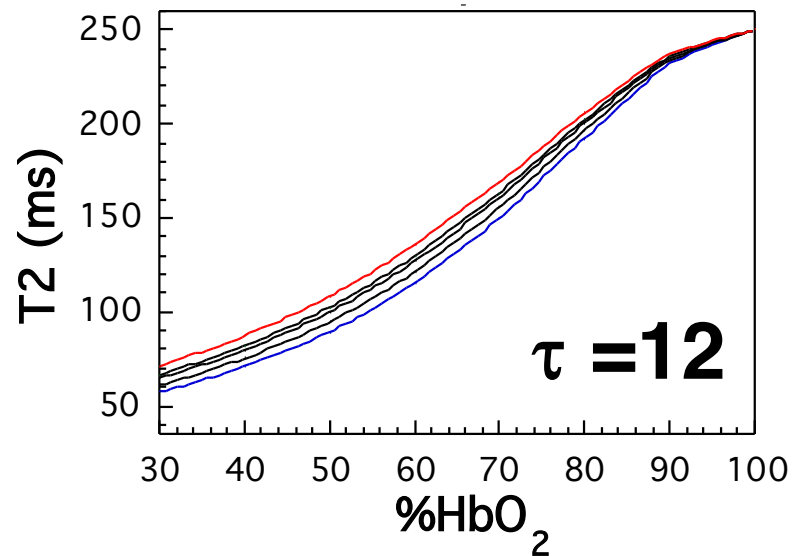
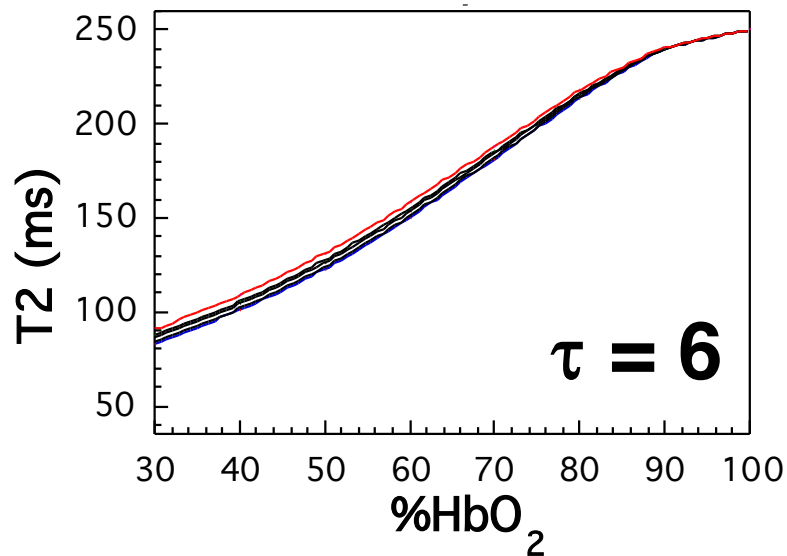

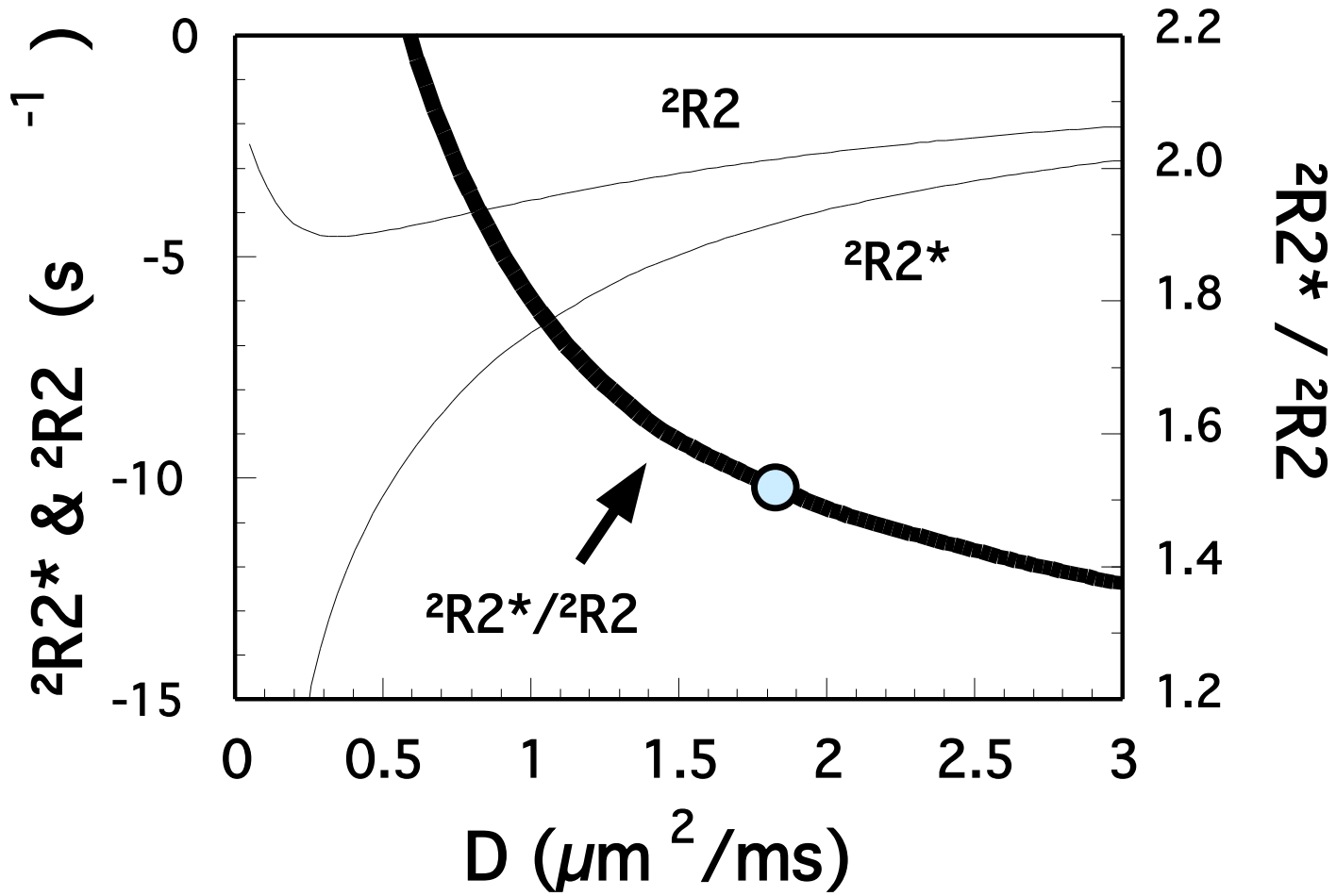

Field -Strength Dependence of T2* and T2

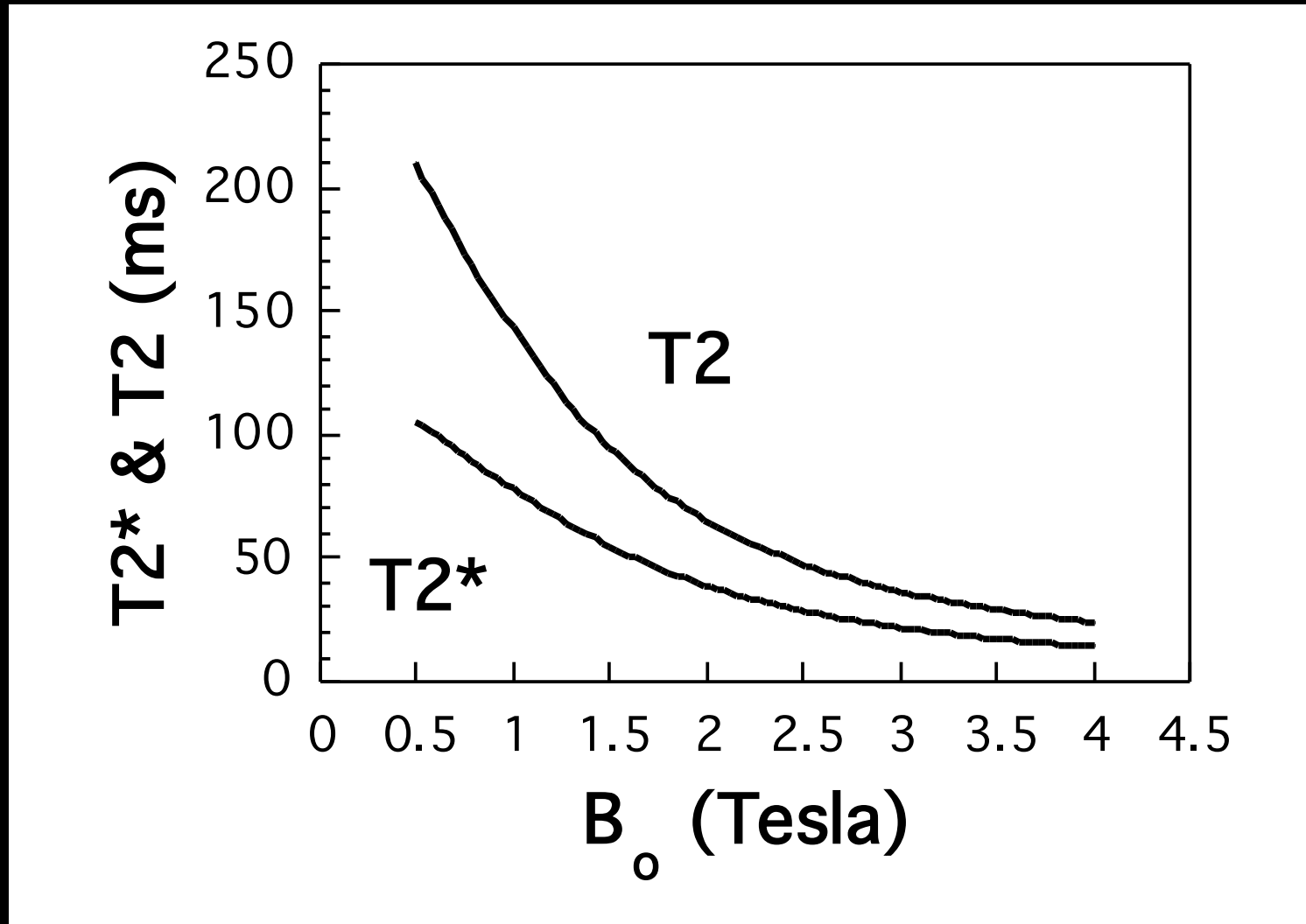

Hct = 44, $\tau = 48$, %HbO₂ = 60, $T_{2_0} = 250$ ms, $T_2' = 120$ ms

Gradient-echo, %HbO₂ = 60

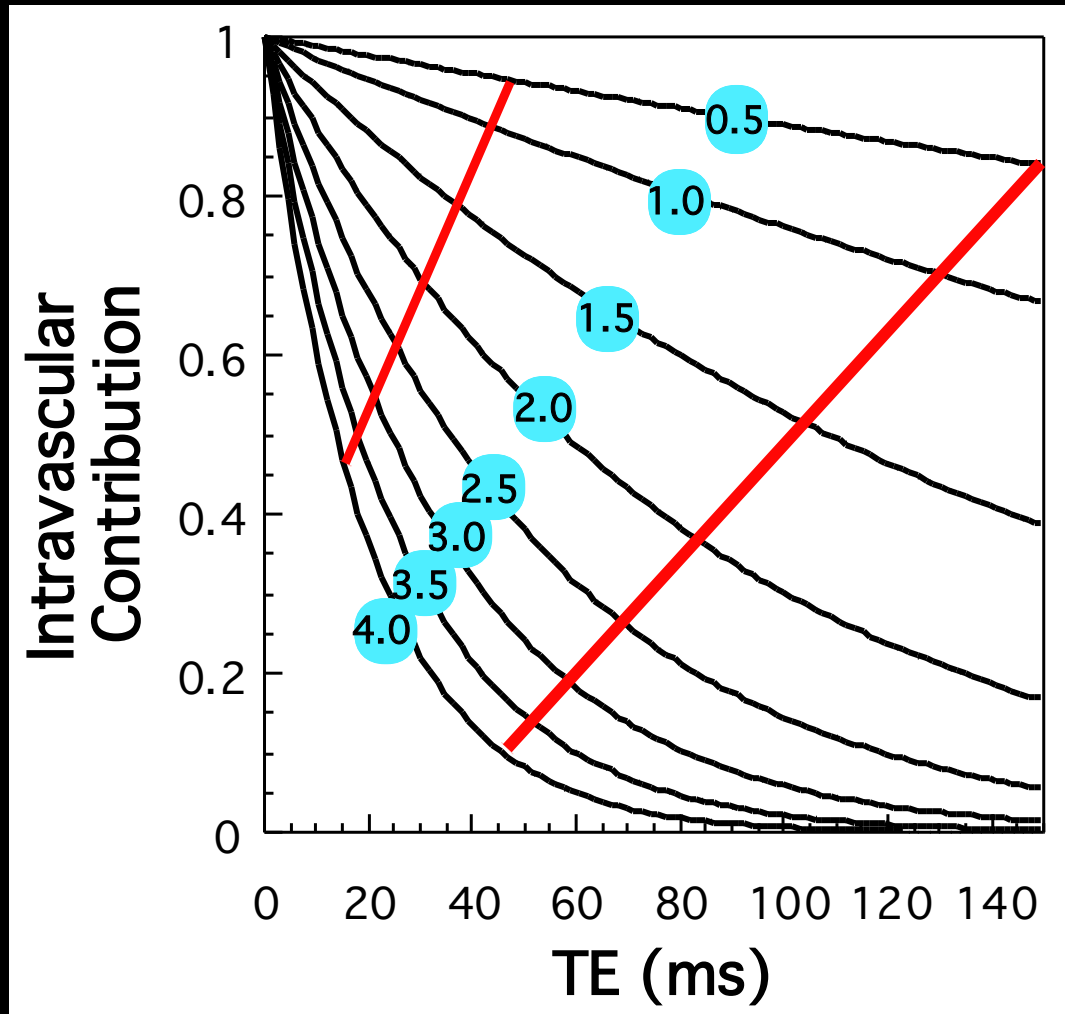

Spin-echo, %HbO₂ = 60

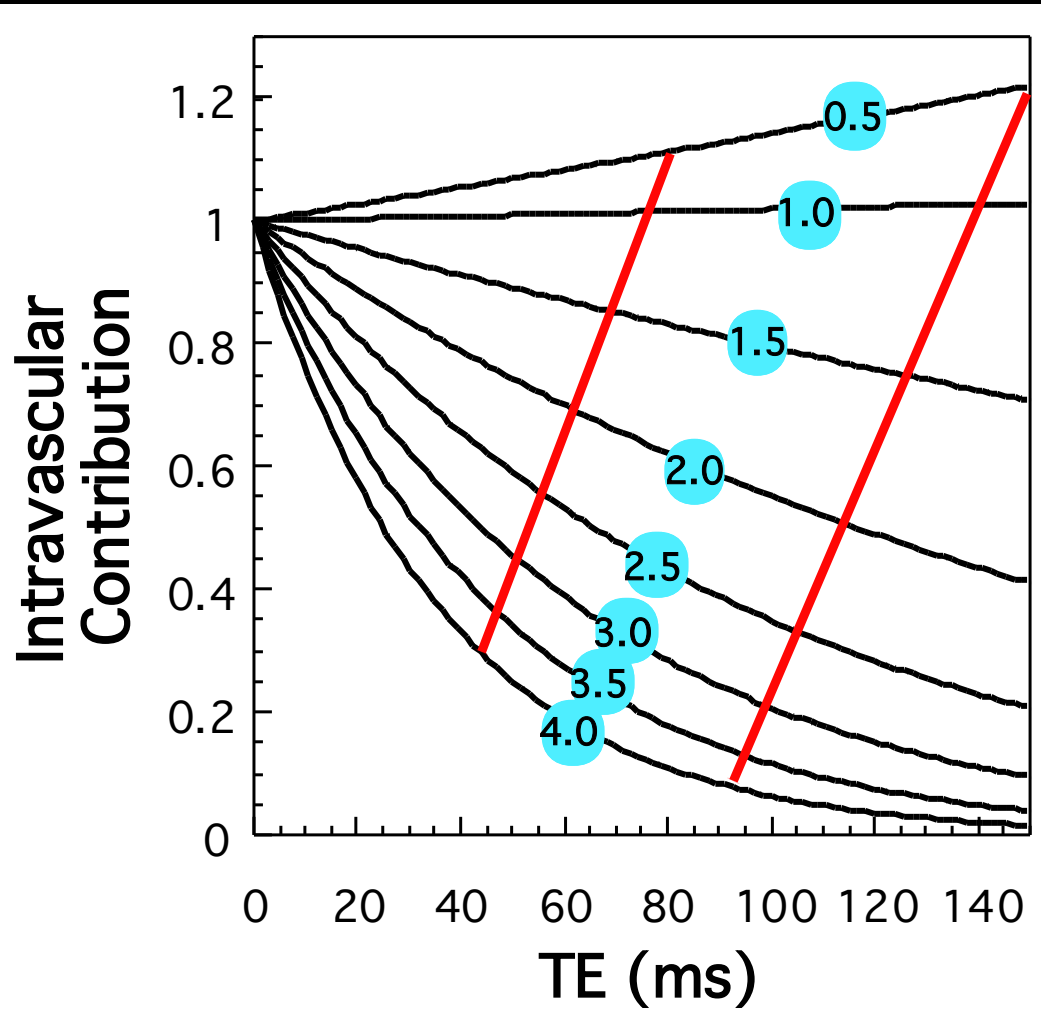

3T

Spin-Echo
TE = 105 ms
TR = ∞



Gradient-Echo
TE = 50 ms



Gradient-Echo
functional
TE = 50 ms

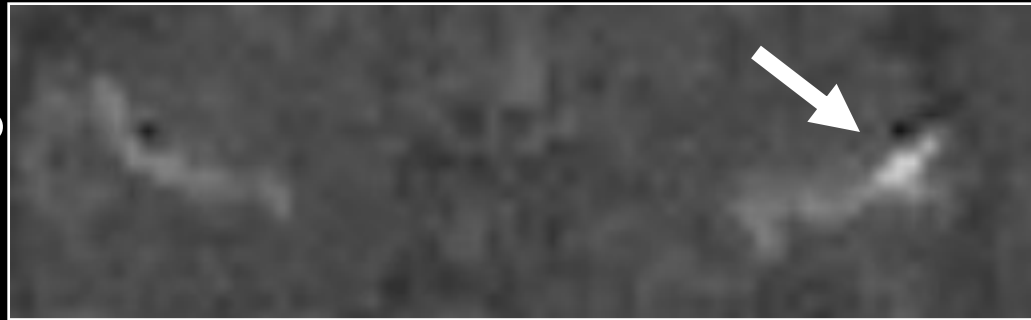

Spin-Echo
functional
TE = 105 ms

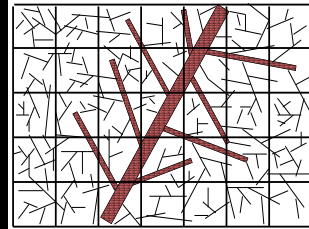

????????????????????????????????????

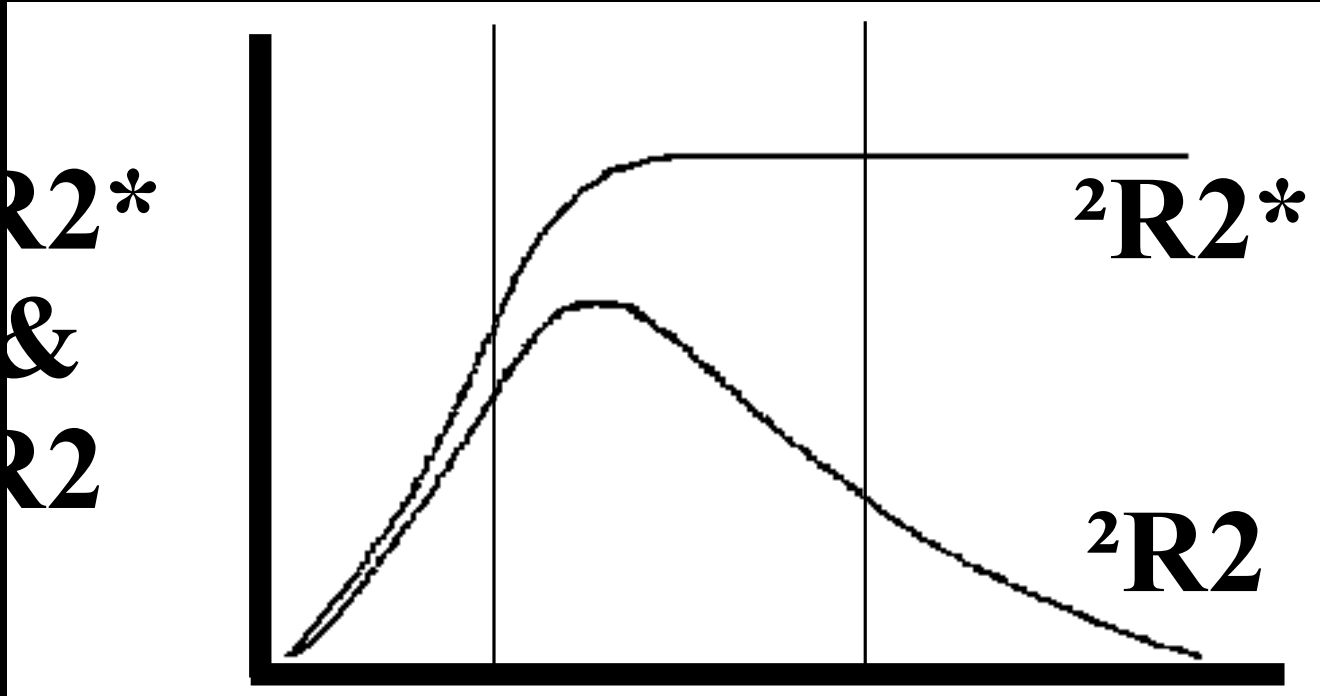

????????????????

????????????????

??????

????????????????????????????????????

$$\Delta R2^* / \Delta R2$$

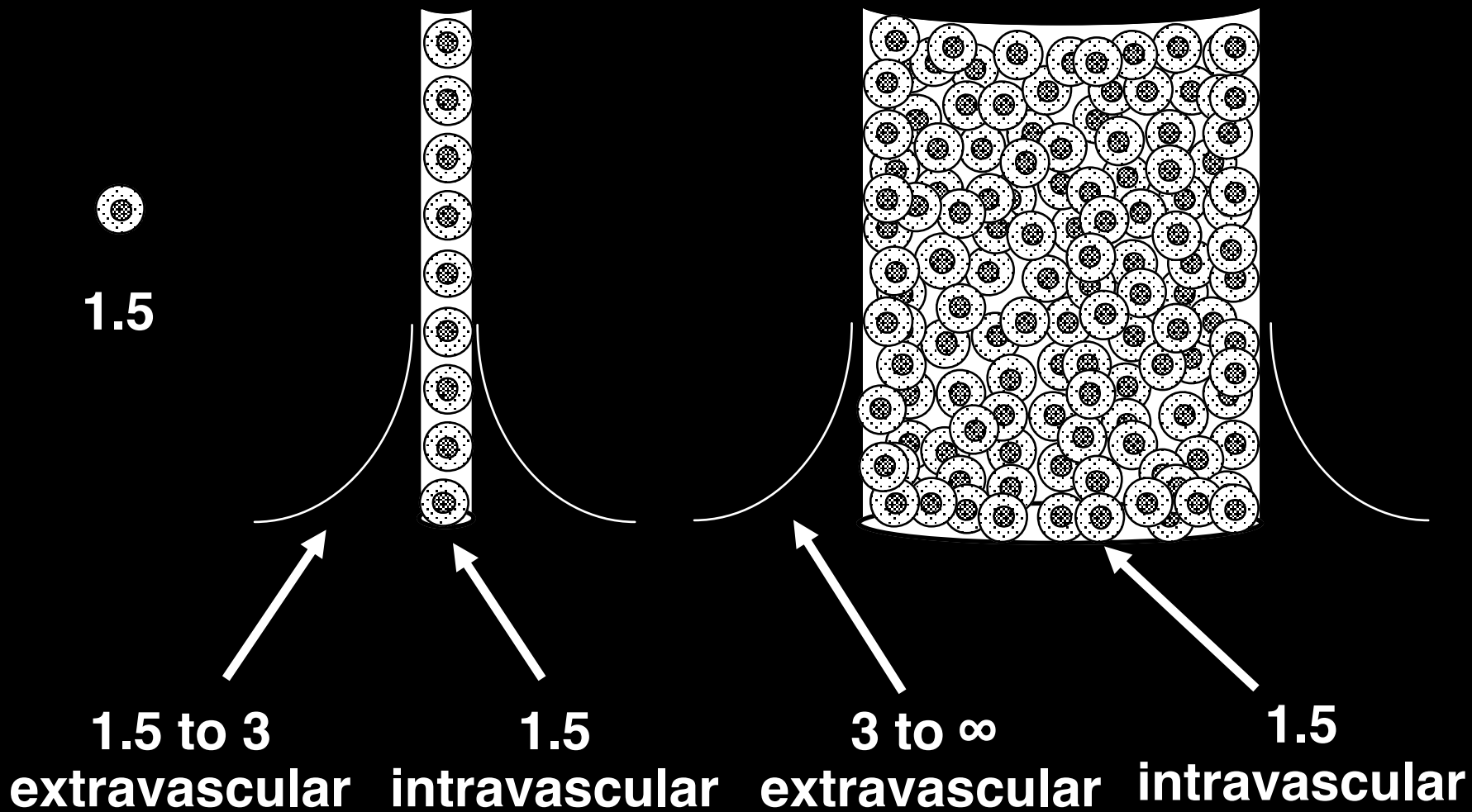

average $\Delta R2^ / \Delta R2 \approx 3$ to 4*

Combined Gradient - Echo and Spin - Echo EPI

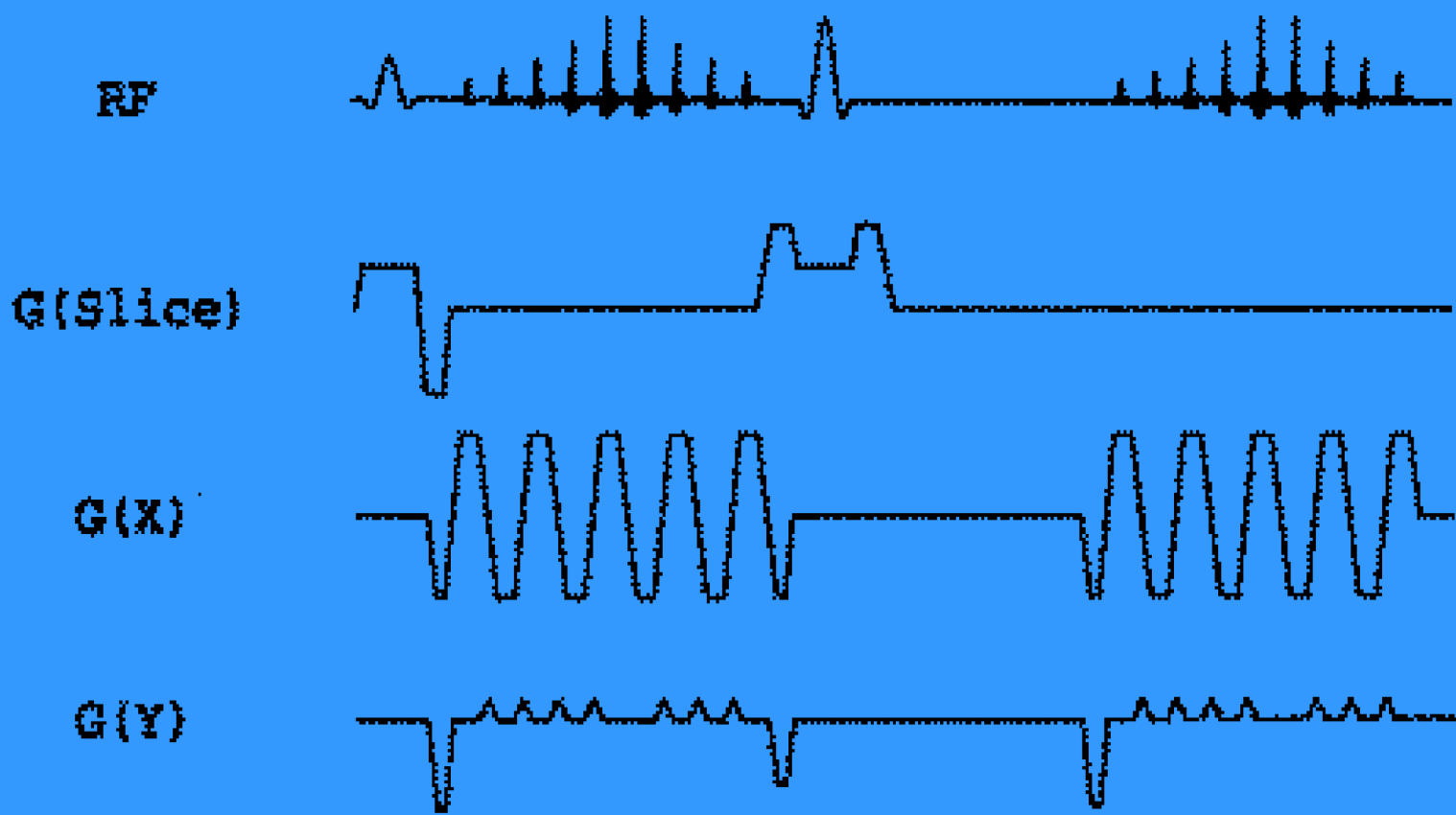



Gradient - Echo

Spin - Echo

**During
Activation
Increase**

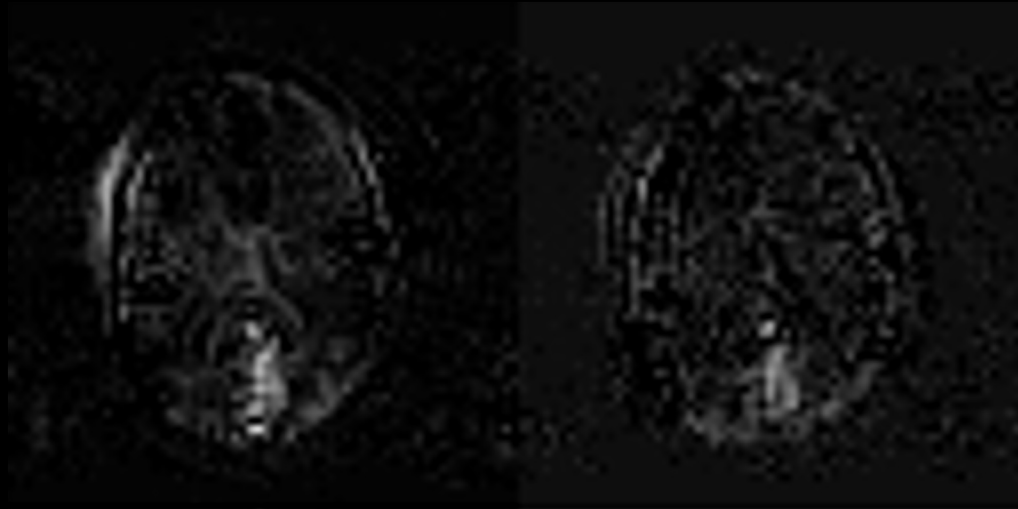

**Post
Activation
Undershoot**

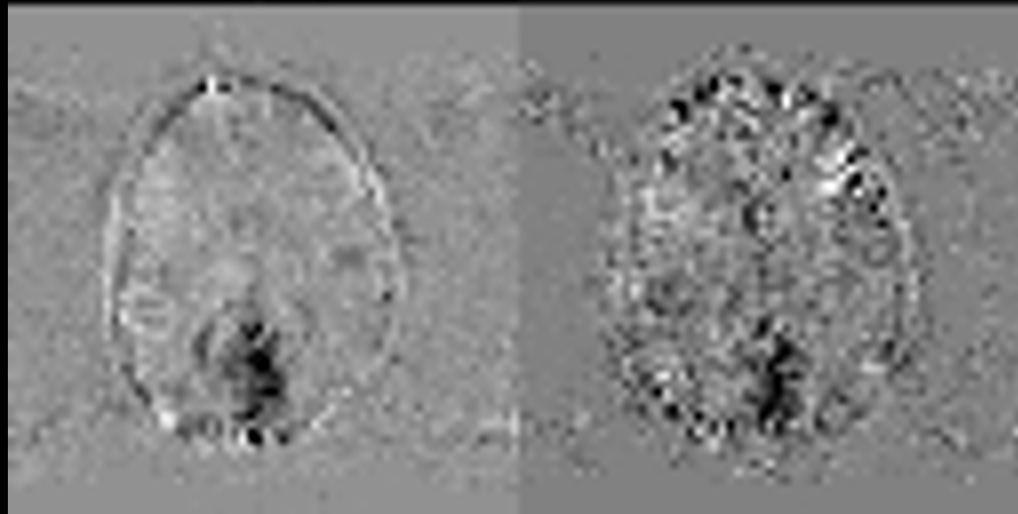

Gradient - Echo

Spin - Echo

**During
Activation
Increase**



**Post
Activation
Undershoot**



no diffusion weighting

diffusion weighting

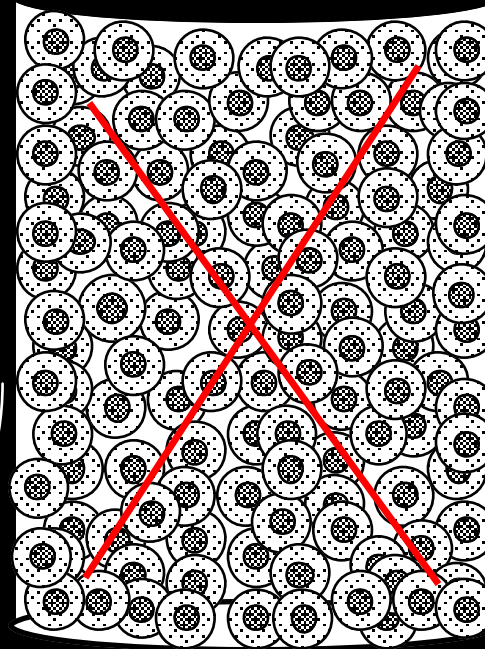
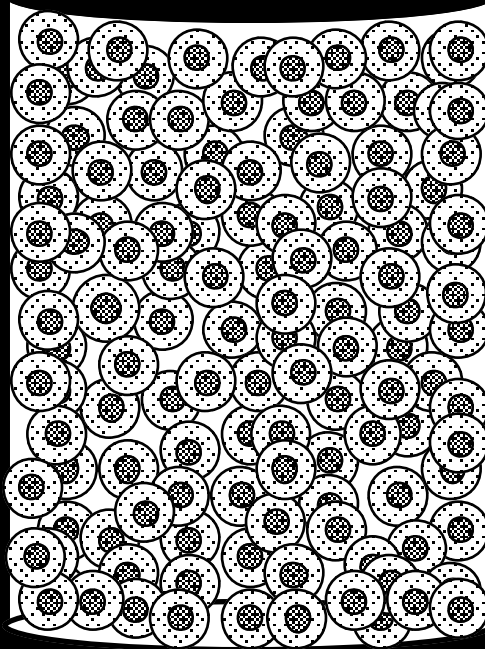

**3 to ∞
extravascular intravascular**

**3 to ∞
extravascular**

$\Delta R2^* / \Delta R2$:

= IV and EV

$\Delta R2^* / \Delta R2$ should increase

= EV only

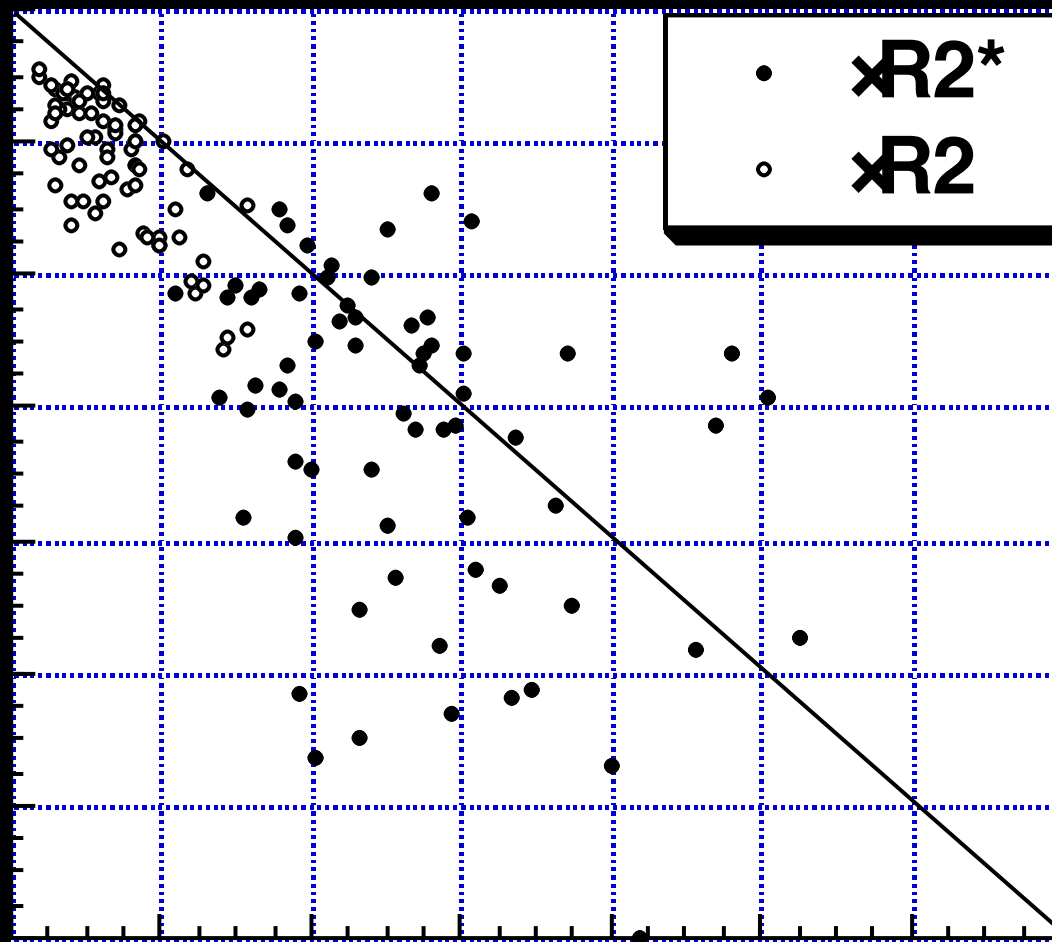

Hemodynamic Specificity

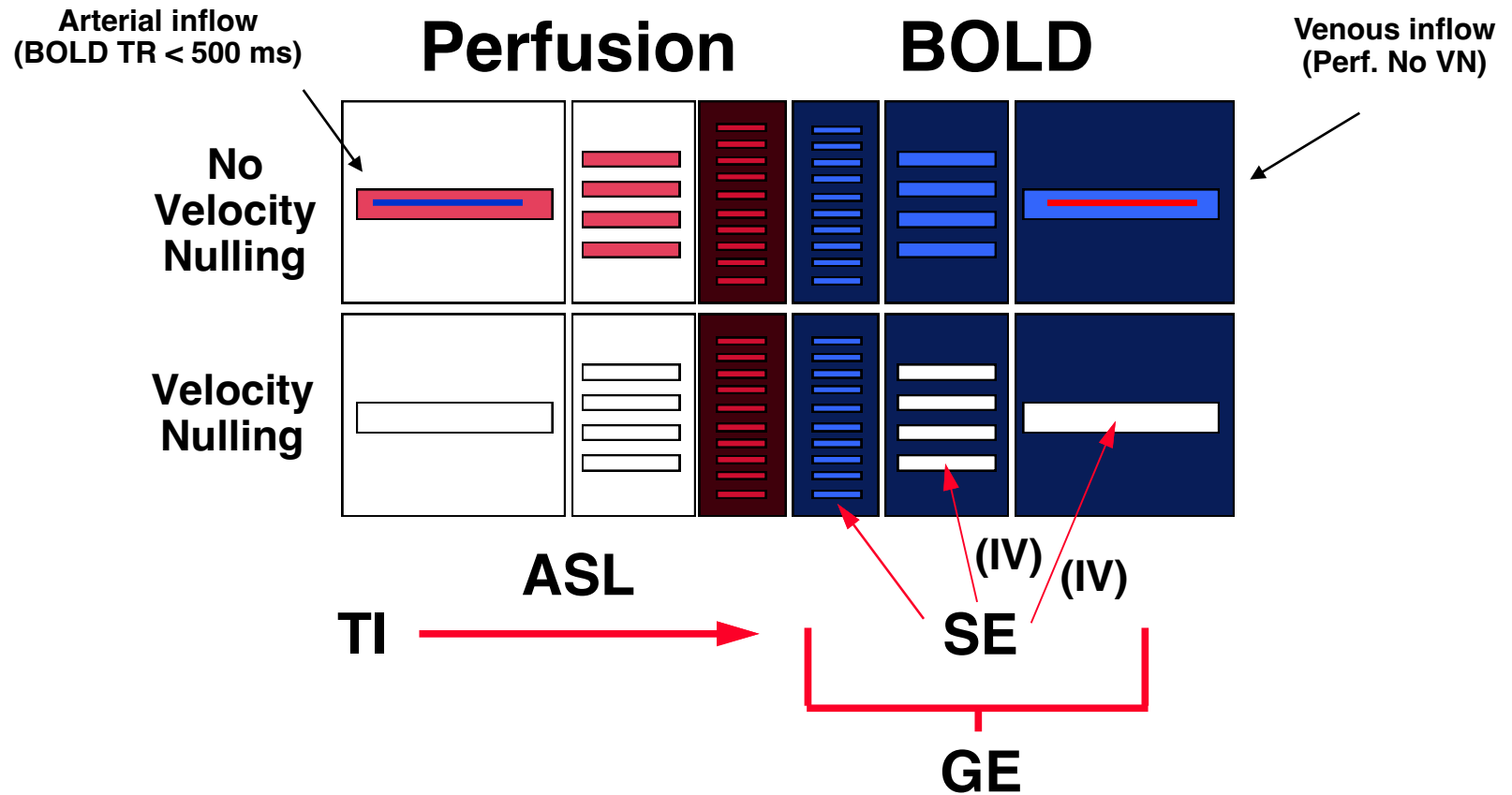

How Much More Information Can we Obtain?

Neuronal Firing Rates

Hemodynamics:

will eventually have quantitative maps of flow, oxygenation, volume, and CMRO₂ as well as other parameters such as velocity, exchange, hematocrit, and vascular responsivity.

Resolution: < 1mm and < 100 ms.

Key:

Neuronal, Physiologic, and Pulse Sequence Modulation

Needs...

More “embedded information” pulse sequences

More specific neuronal activation and physiologic stresses

Which requires...

Extreme sensitivity (high field strength)

Functional Imaging Methods / 3T Group

Staff Scientists

Jerzy Bodurka
Sean Marrett

Post Docs

Rasmus Birn
Patrick Frost-Bellgowan
Ziad Saad

Graduate Student

Natalia Petridou

Psychologist

Julie Frost-Bellgowan

Program Assistant

Kay Kuhns



$$\Delta R2^* / \Delta R2$$

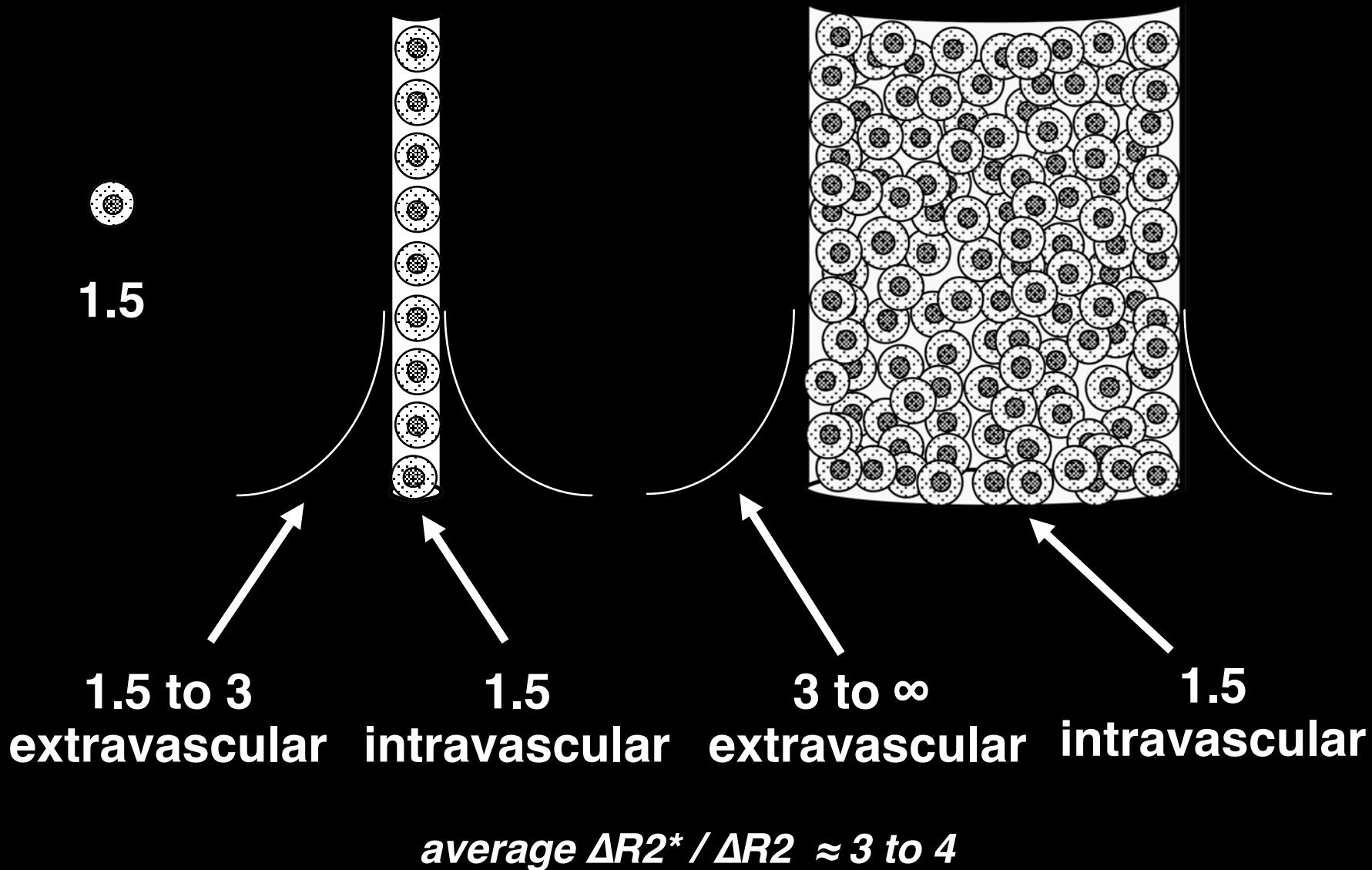

Further Advancements?

More pulse sequence modulation

Model fitting and constraining

Simultaneous collection of multiple types of baseline and time series information

Spatial mapping of dynamic characteristics with well controlled stimuli

High Field Strength:

Ask questions across spatial resolution scales

Ask more subtle questions about dynamics and magnitudes

Reduced intravascular effects

Create MAPS of these effects..

Maps:

Spin-echo vs. gradient-echo

Flow vs. BOLD

Latency

Post undershoot

Pre undershoot

Balloon model parameters

Diffusion attenuation

Correlation with parametric task modulation

Noise correlation

**Single - Shot EPI at 3T:
Half NEX, 256 x 256, 16 cm FOV**

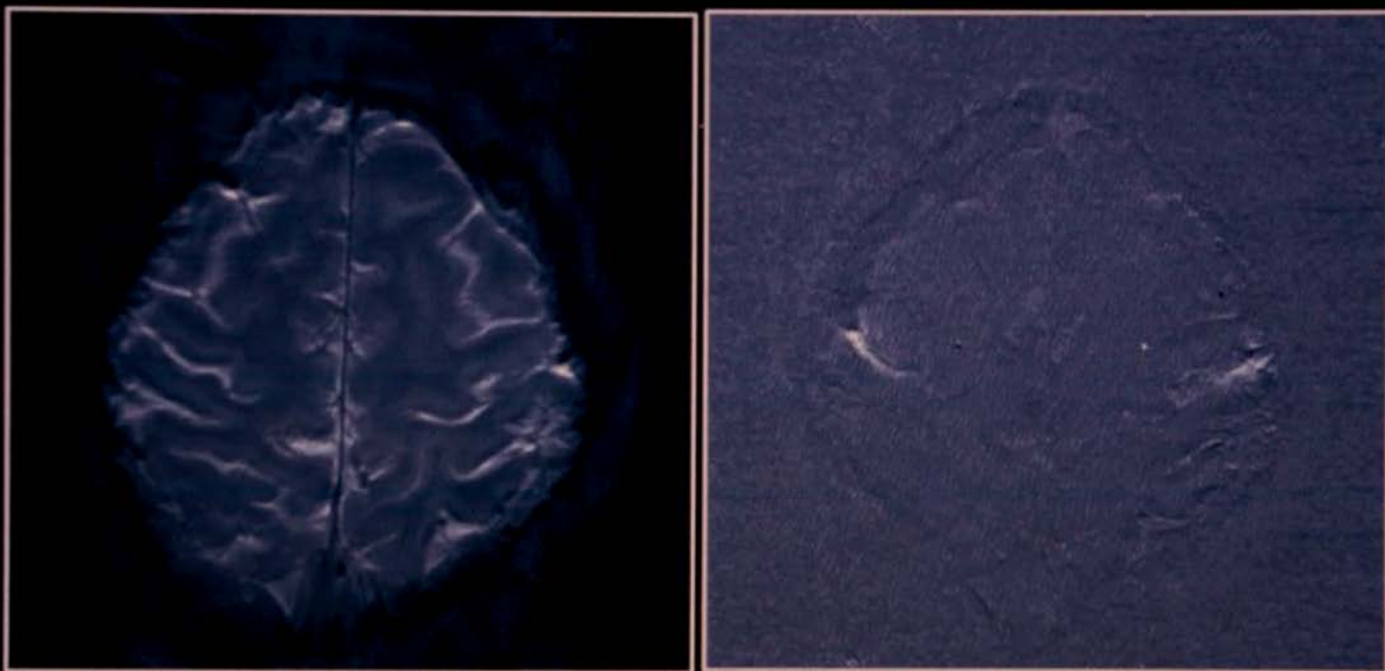

**Single - Shot EPI at 3T:
Half NEX 256 x 256, 16 cm FOV**

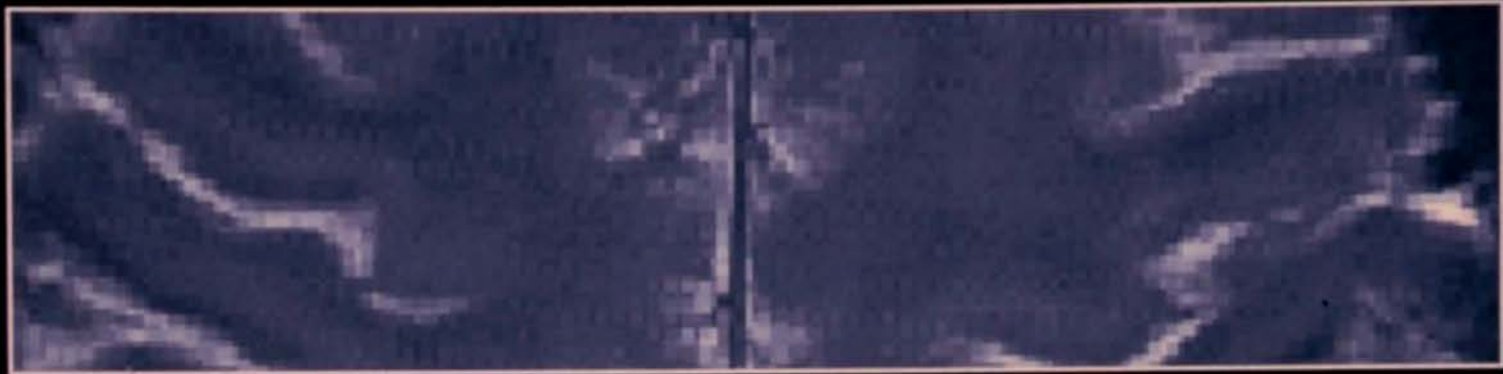

Simultaneous Flow and BOLD

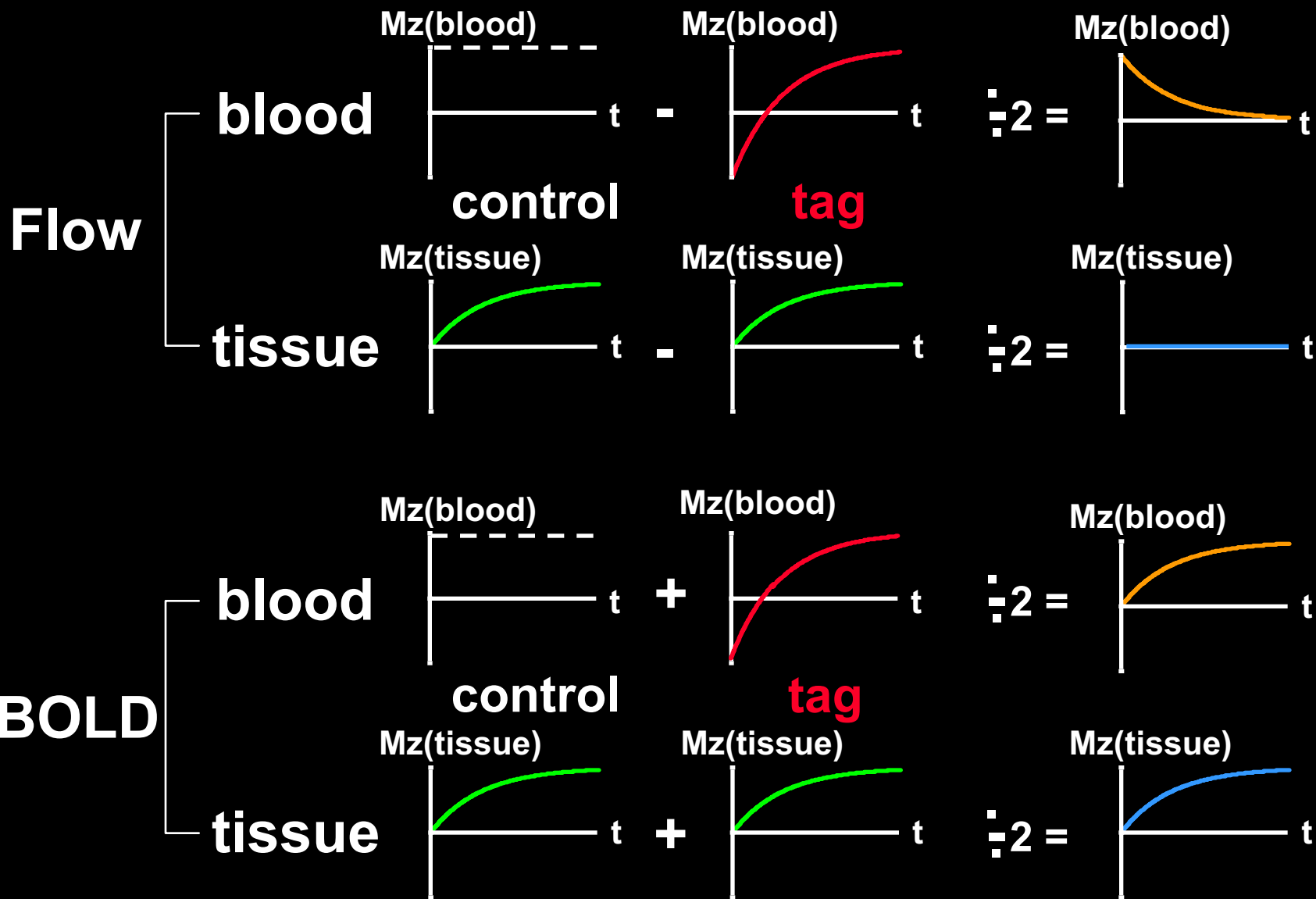

Simultaneous BOLD and Perfusion



BOLD

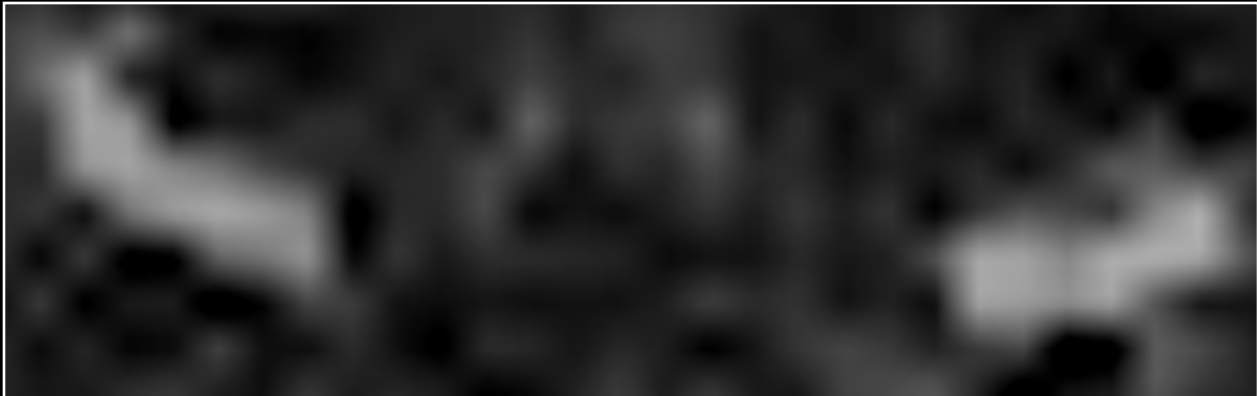

Perfusion

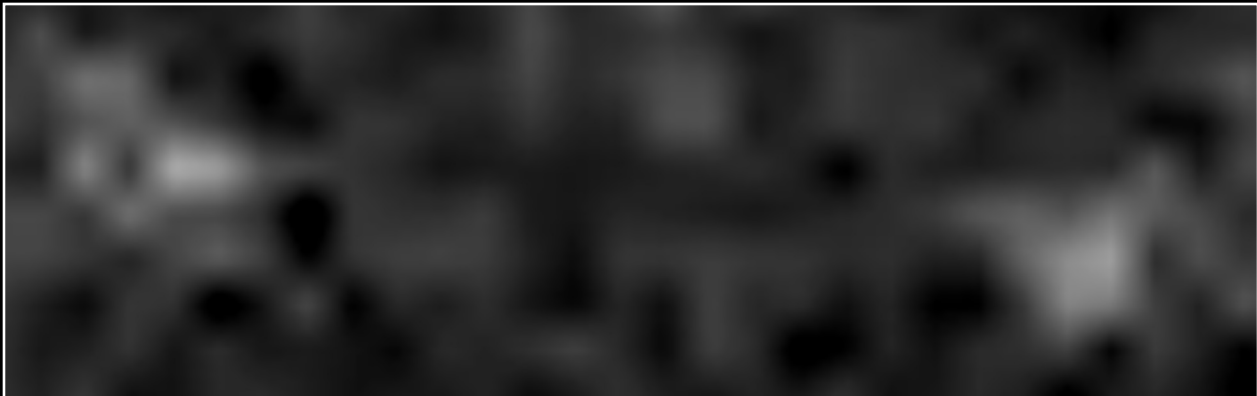

Simultaneous BOLD and Perfusion

perfusion

BOLD

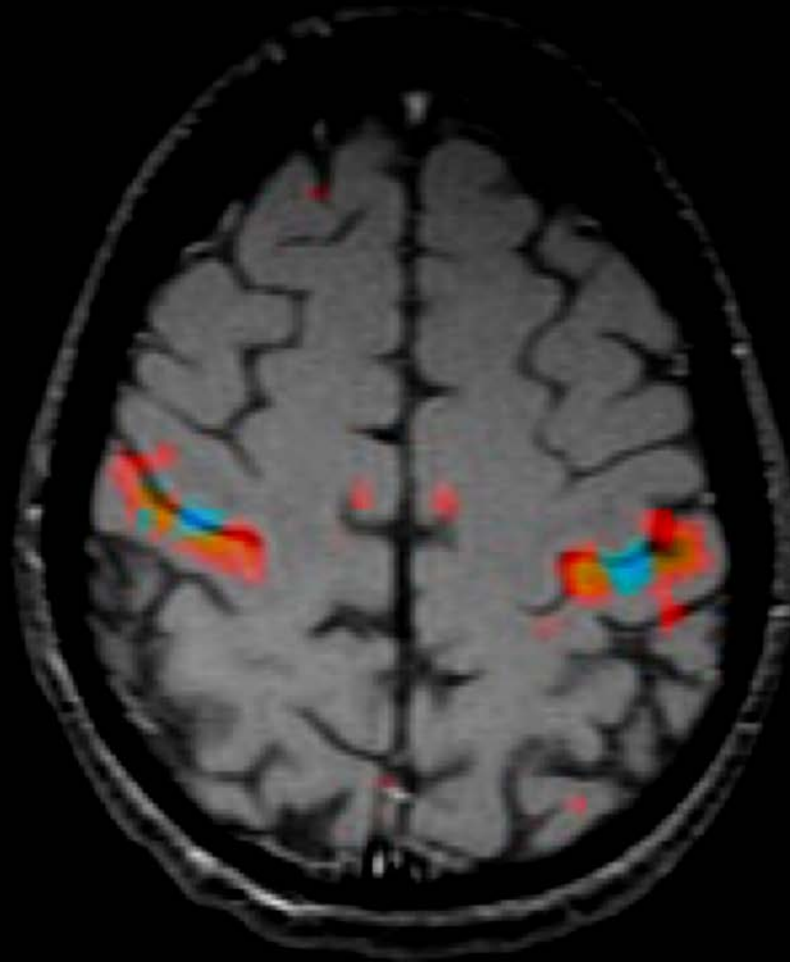

Angiogram
Perfusion
BOLD

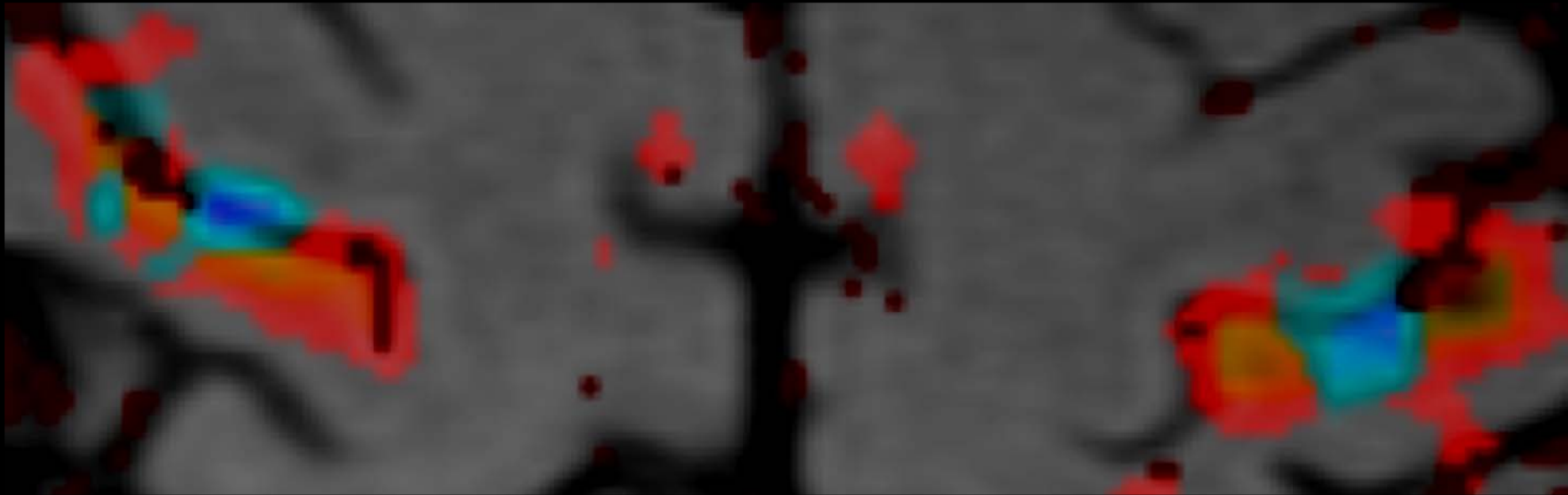



??????

????????????????

????????

????????????????

????????????????

????????????

????

????????

????????

????????

????????

????????

????????

????????

????????

????????

????????

????????

????????

????????

????????

CMRO₂-related BOLD signal deficit:

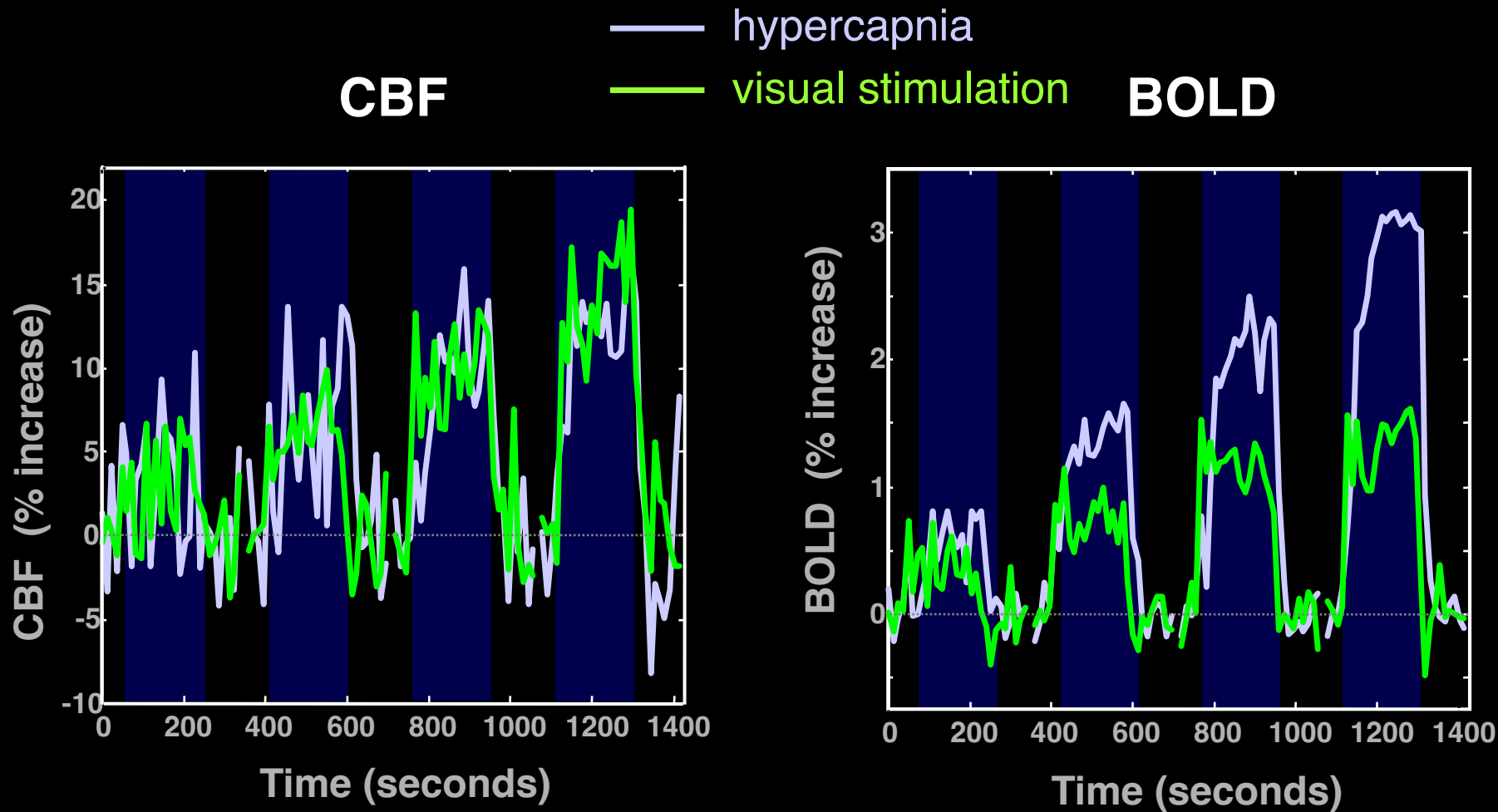

Simultaneous Perfusion and BOLD imaging during graded visual activation and hypercapnia

N=12

Estimating R_{AB} and S_{AB}

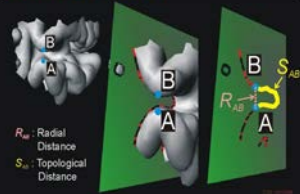

Regions Susceptible to Mapping Errors

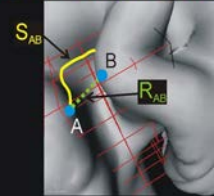

Susceptibility to Mapping Errors, S_{AB} / R_{AB}

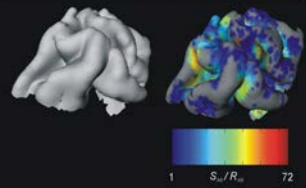

Cortical Surface and Voxel Matrix

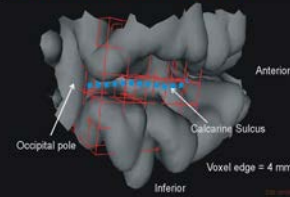

Vascular Sensitization

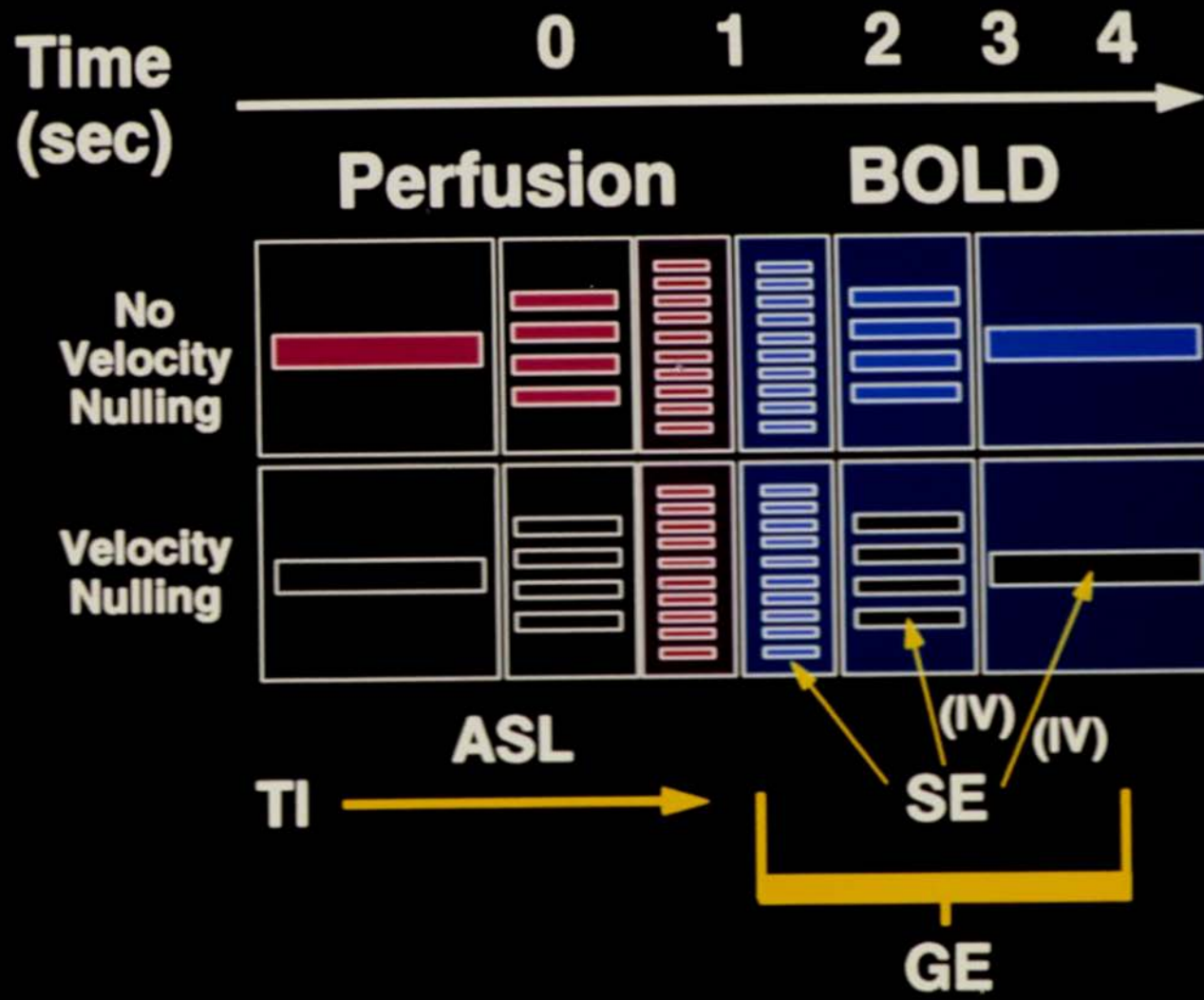

GE
TE = 30 ms

SE
TE = 110 ms

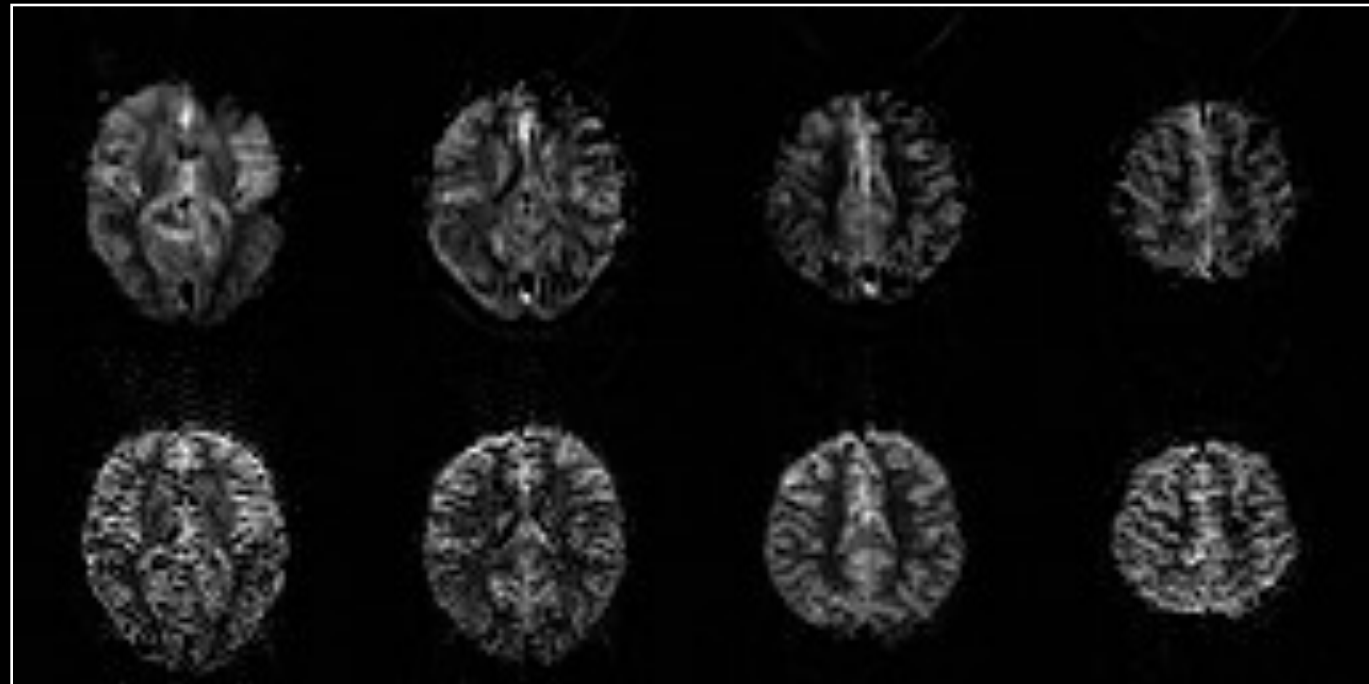

Vascular Sensitization

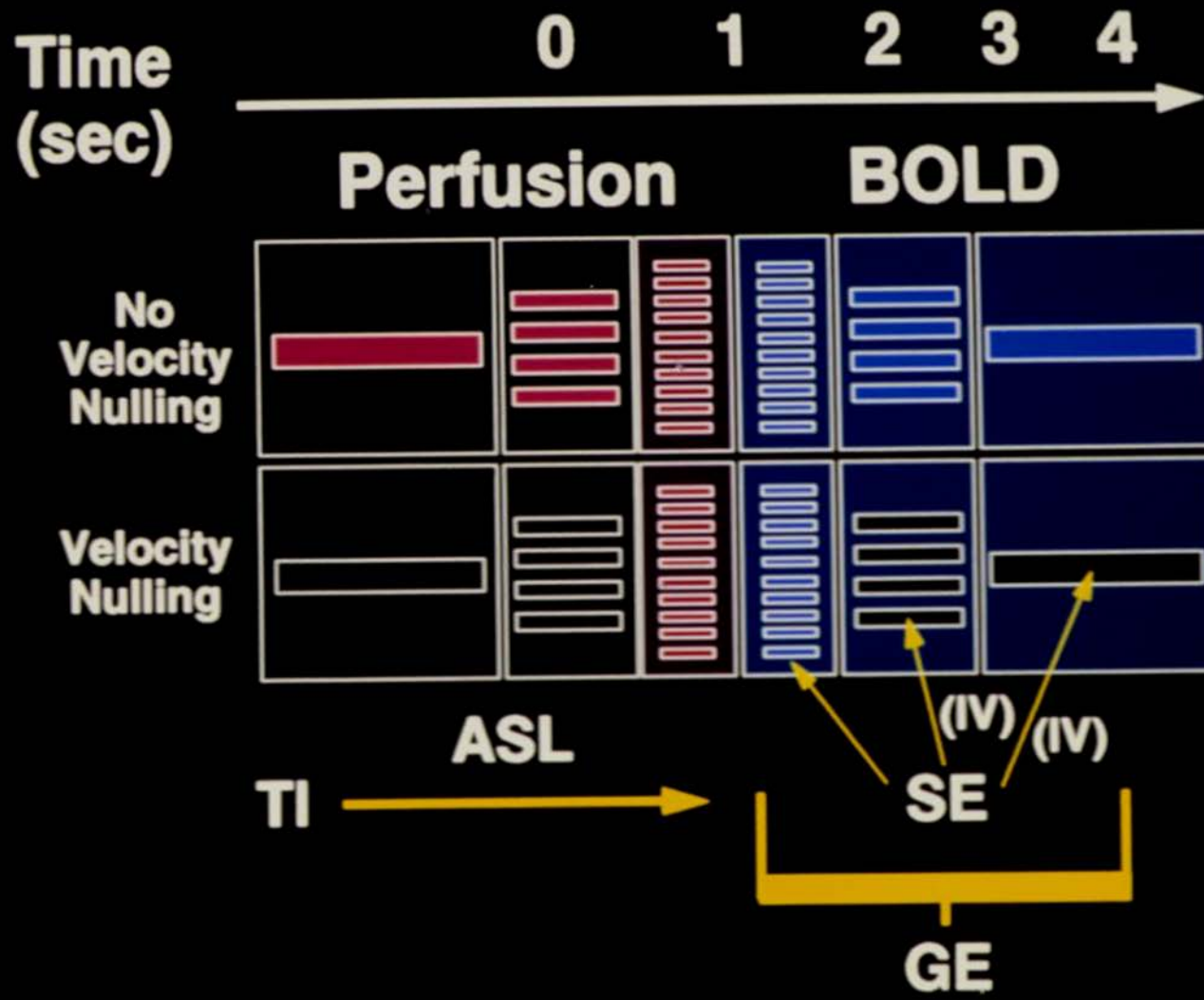

Field -Strength Dependence of $R2^*$ and $R2$

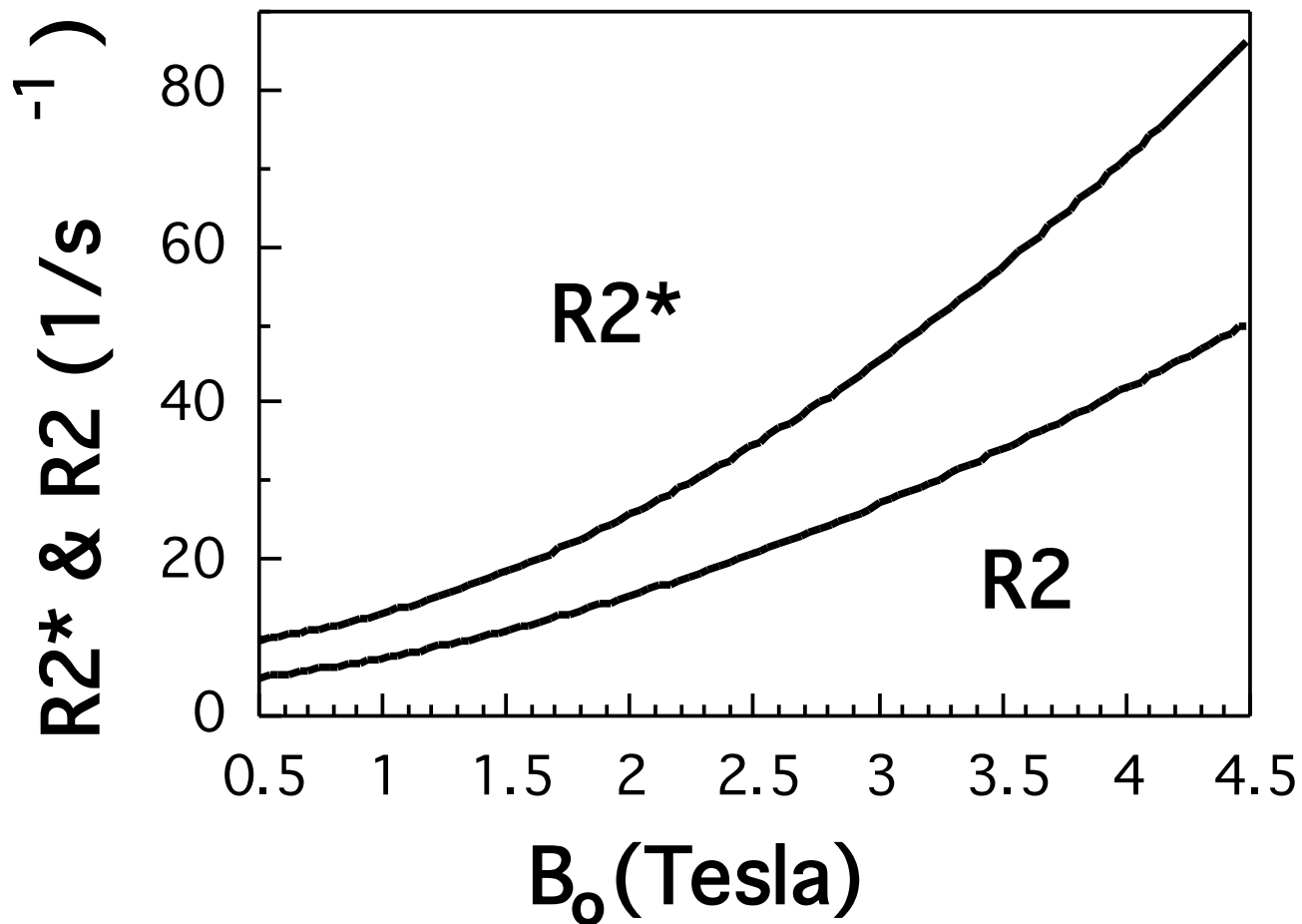

$Hct = 44$, $\tau = 48$, $\%HbO_2 = 60$, $R2_0 = 4.0 \text{ s}^{-1}$, $R2'_0 = 8.3 \text{ s}^{-1}$

Relative R2* and R2 dependence on %HbO₂

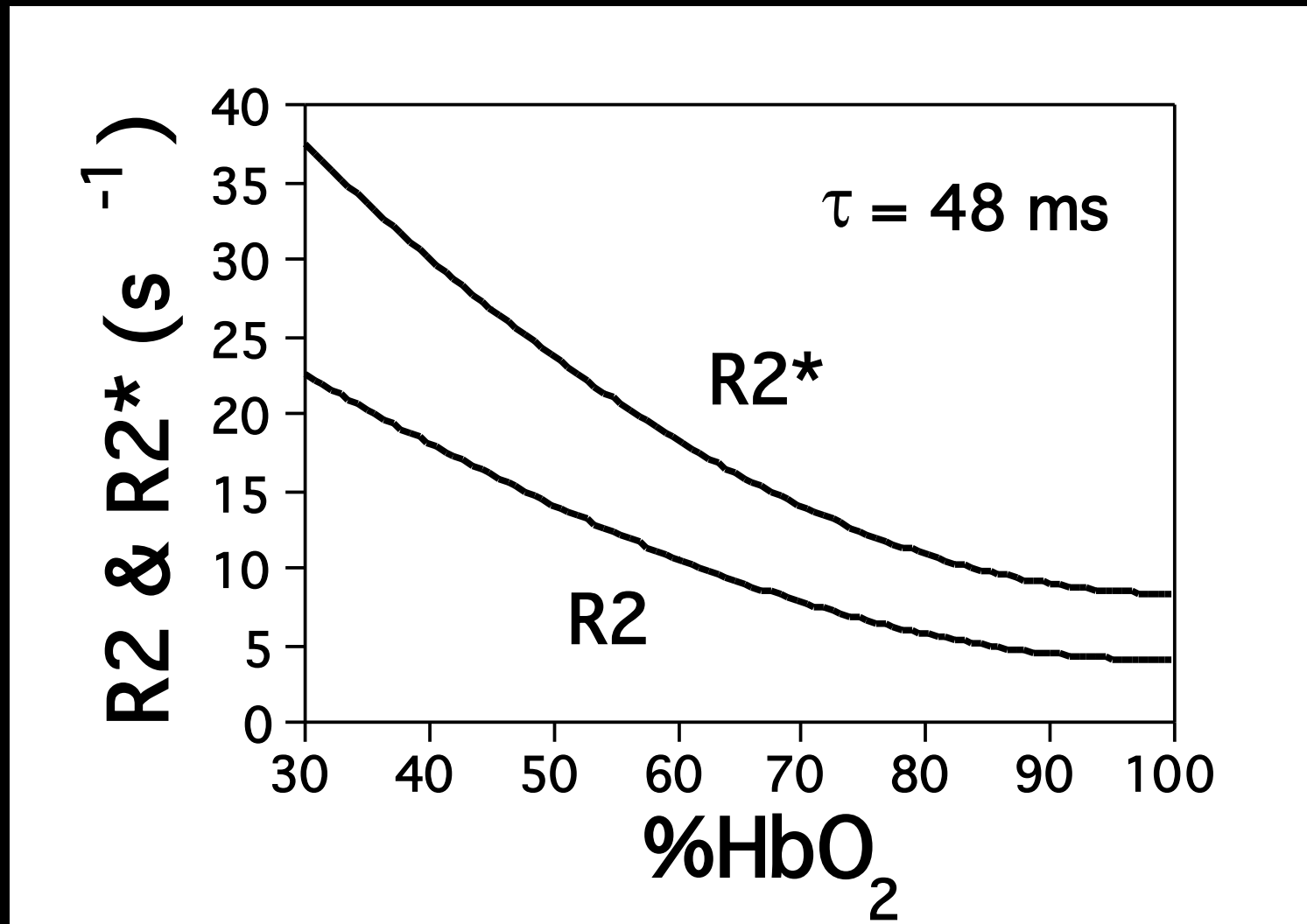

Hct = 44, $D = 1.8 \mu\text{m}^2 / \text{ms}$, $R2_o = 4.0 \text{ s}^{-1}$, $R2'_o = 8.3 \text{ s}^{-1}$

Field -Strength Dependence of R2* and R2

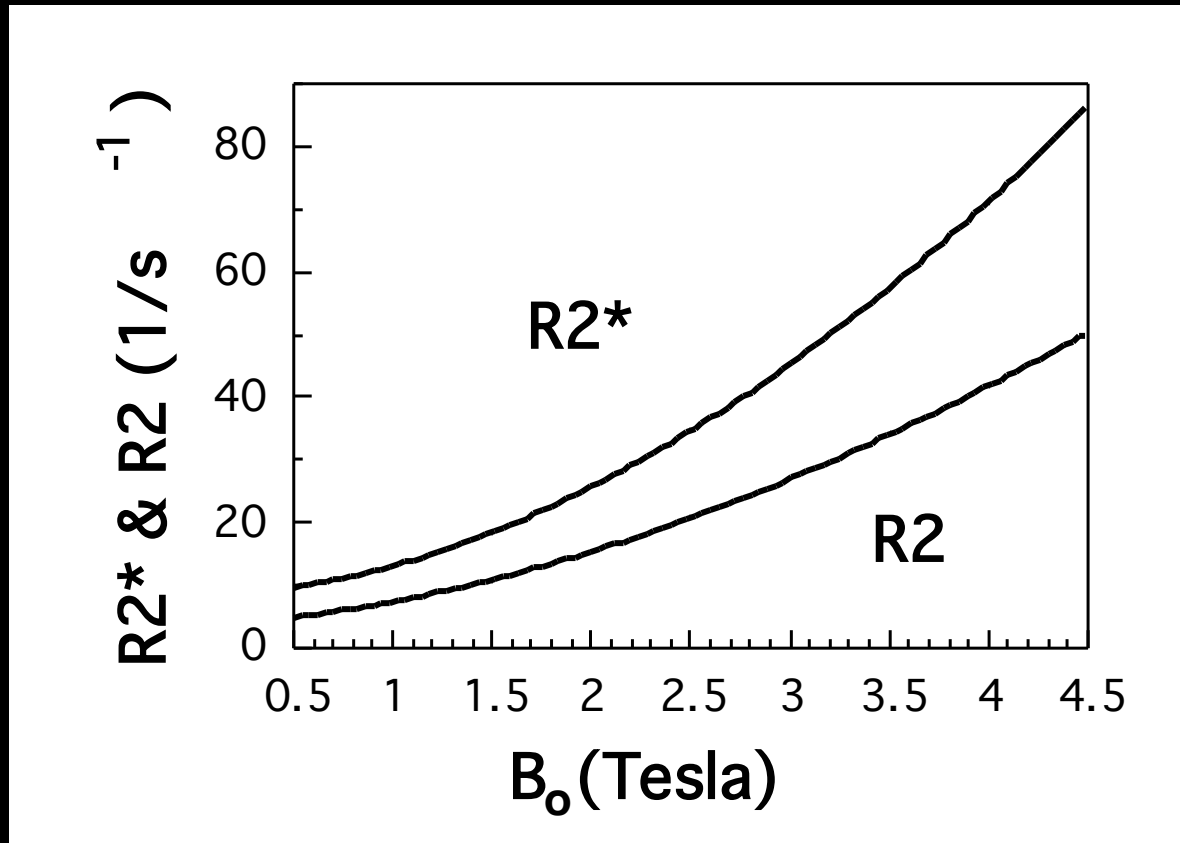

$$R2^* = 8.33 + 4.8 \times B_0^{1.85}$$

$$R2 = 4.0 + 4.8 \times B_0^{1.73}$$

$$\text{Hct} = 44, \tau = 48, \% \text{HbO}_2 = 60, R2_0 = 4.0 \text{ s}^{-1}, R2'_0 = 8.3 \text{ s}^{-1}$$

Field -Strength Dependence of T2* and T2

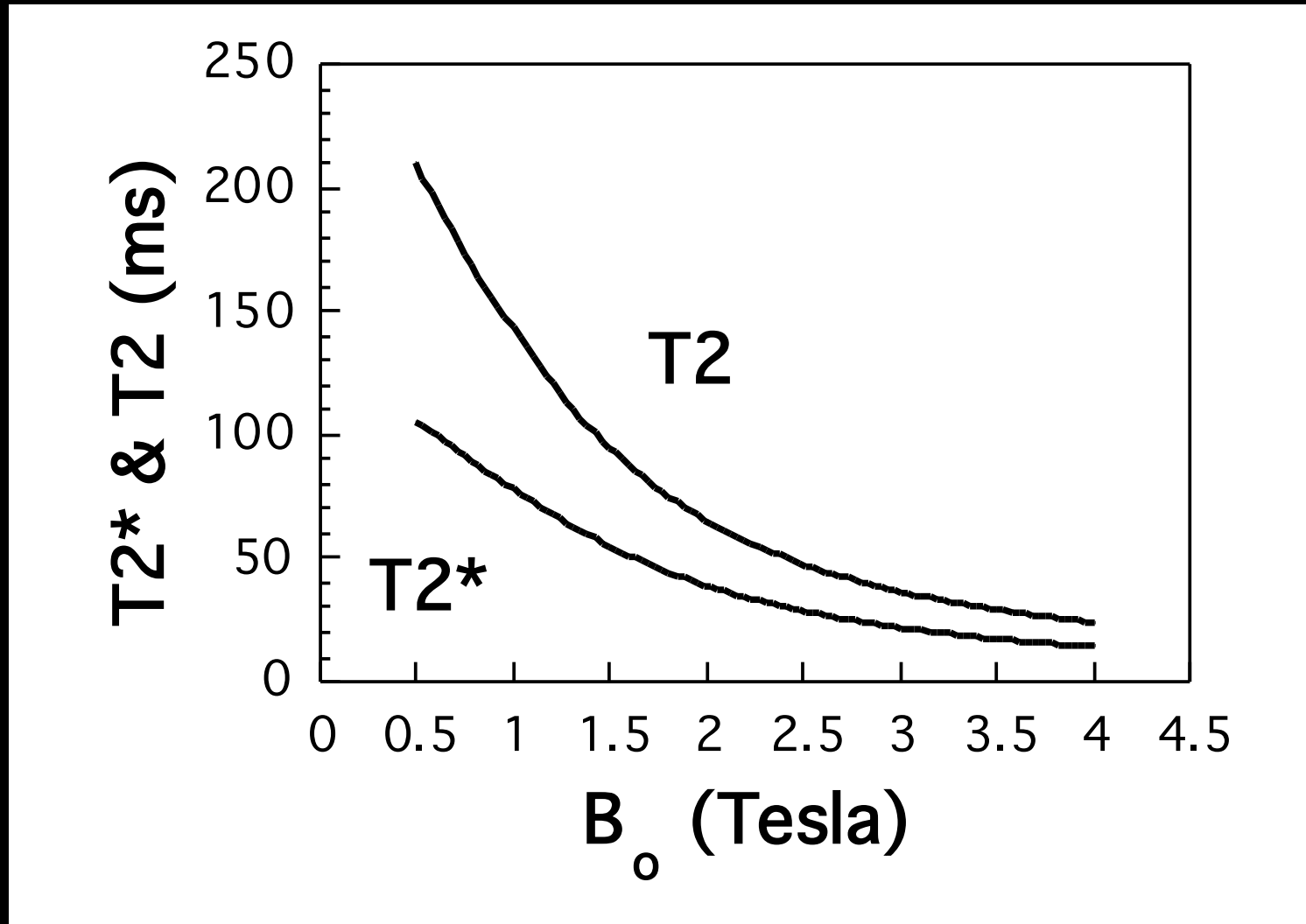

Hct = 44, $\tau = 48$, %HbO₂ = 60, $T_{2_0} = 250$ ms, $T_2' = 120$ ms

Relaxation rate *change* dependence on field strength

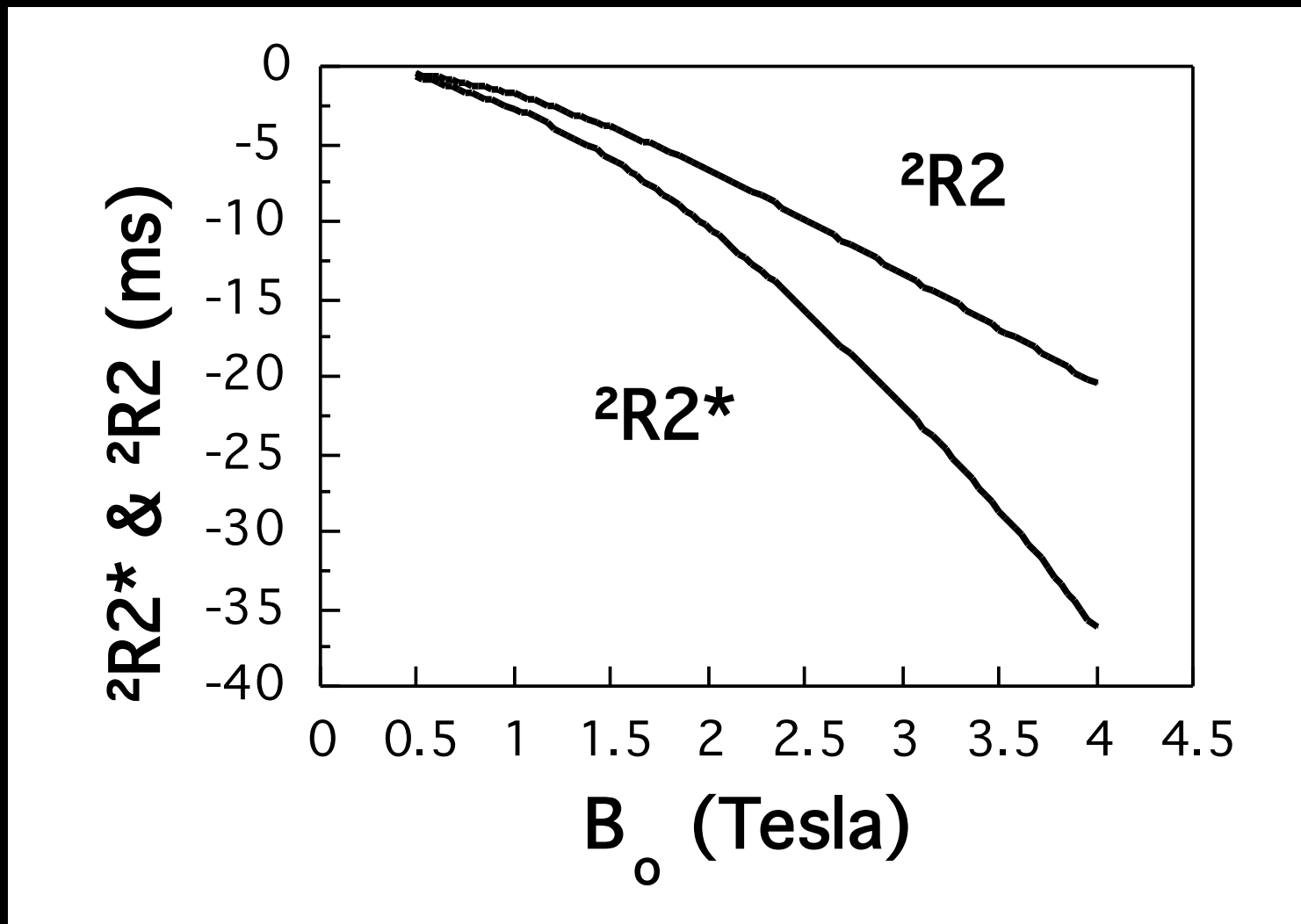

%HbO₂ = 60 -> 75, Hct = 44, τ = 48

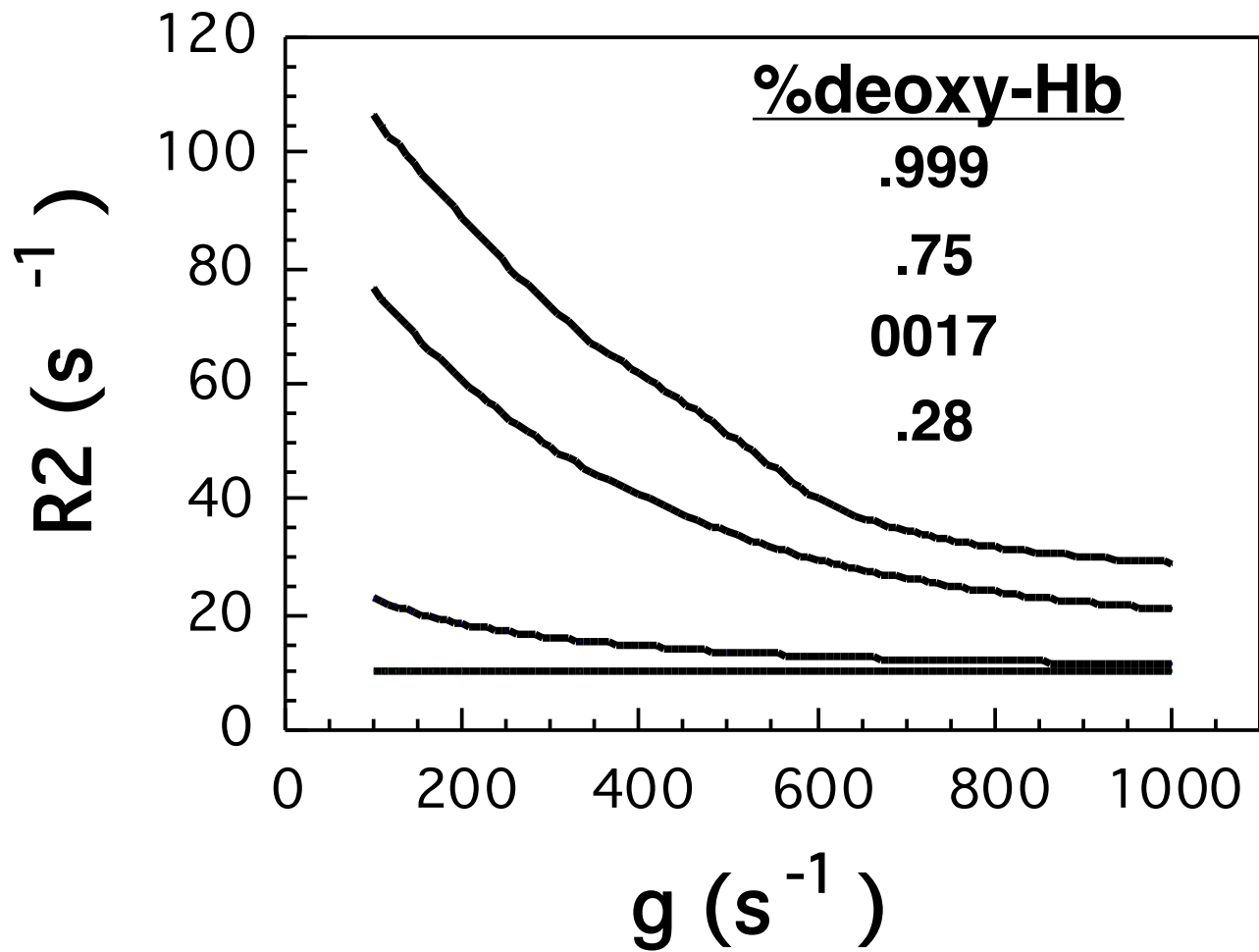

Hct = 44, $R_{2_0} = 4.0 s^{-1}$

Cell Radius Effect

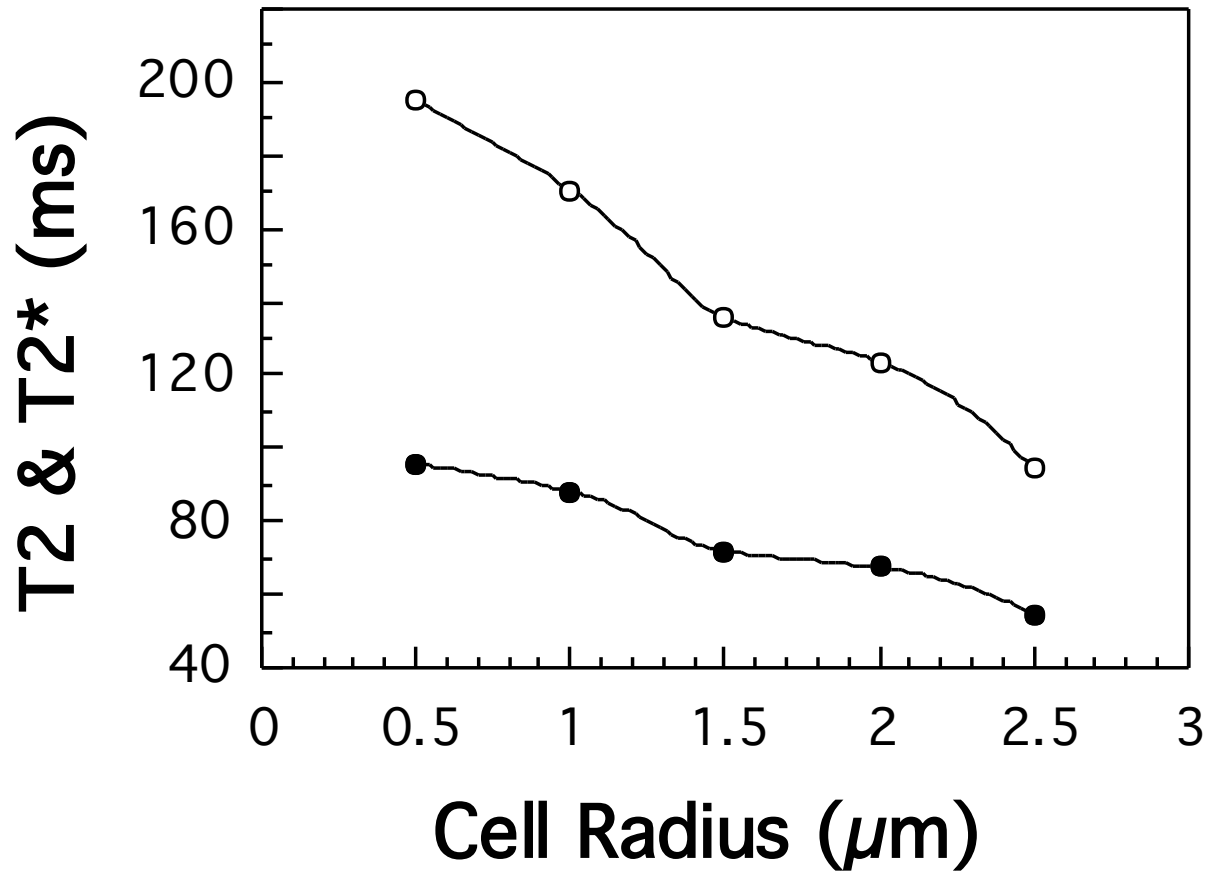

Hct = 44, $\tau = 48$, %HbO₂ = 60, T2_o = 250 ms, T2' = 120 ms

Hematocrit Effect

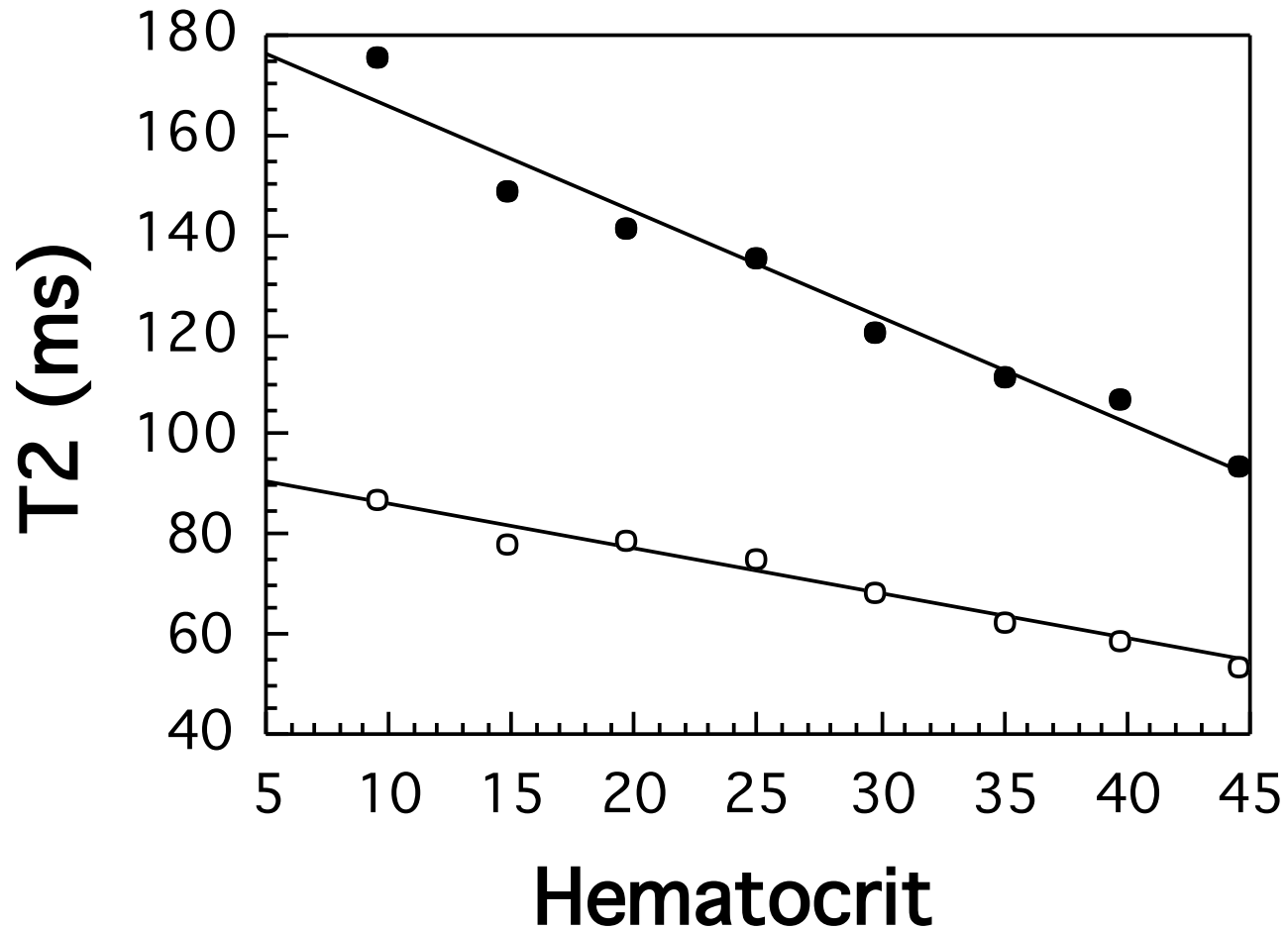

$\tau = 48$, $\%HbO_2 = 60$, $T2_o = 250$ ms, $T2' = 120$ ms

Hematocrit Effect

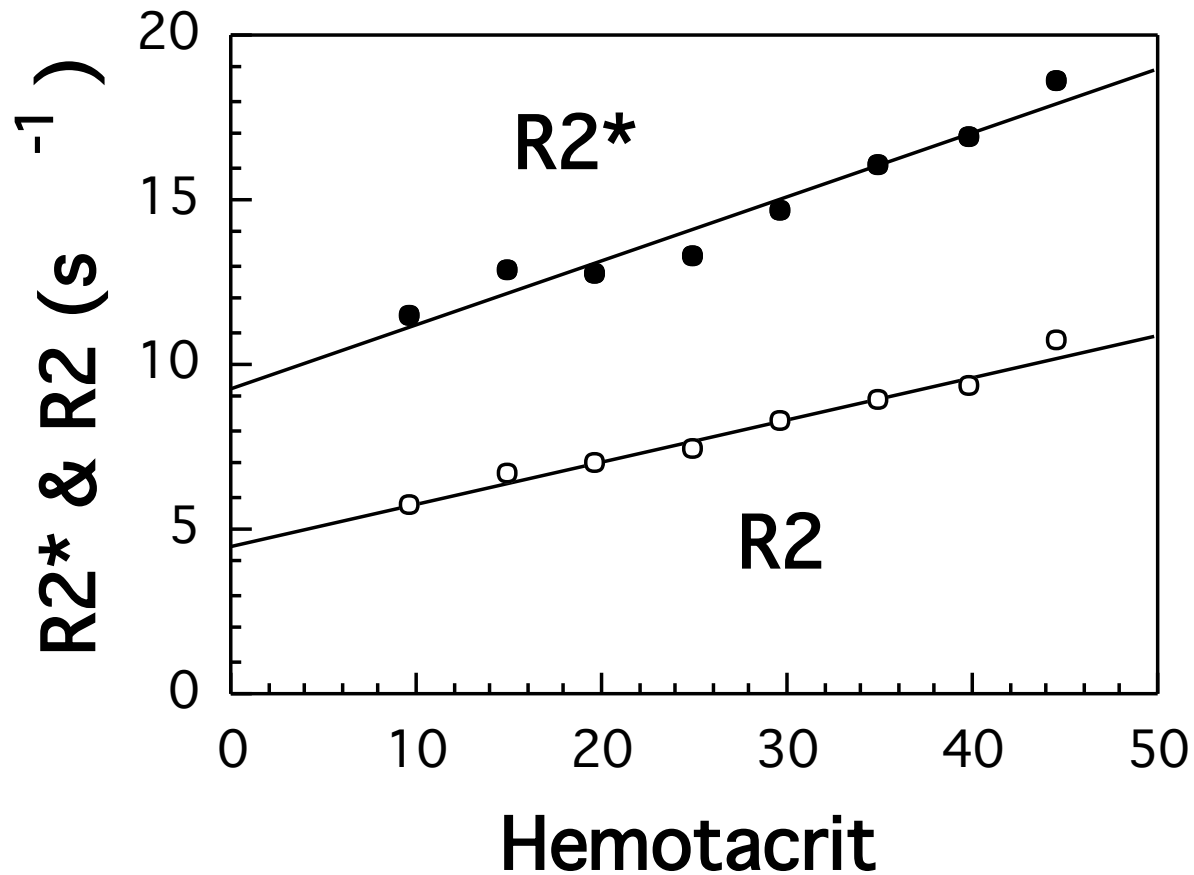

$\tau = 48, \%HbO_2 = 60, R2_o = 4.0 \text{ s}^{-1}, R2'_o = 8.3 \text{ s}^{-1}$

Cell Radius Effect

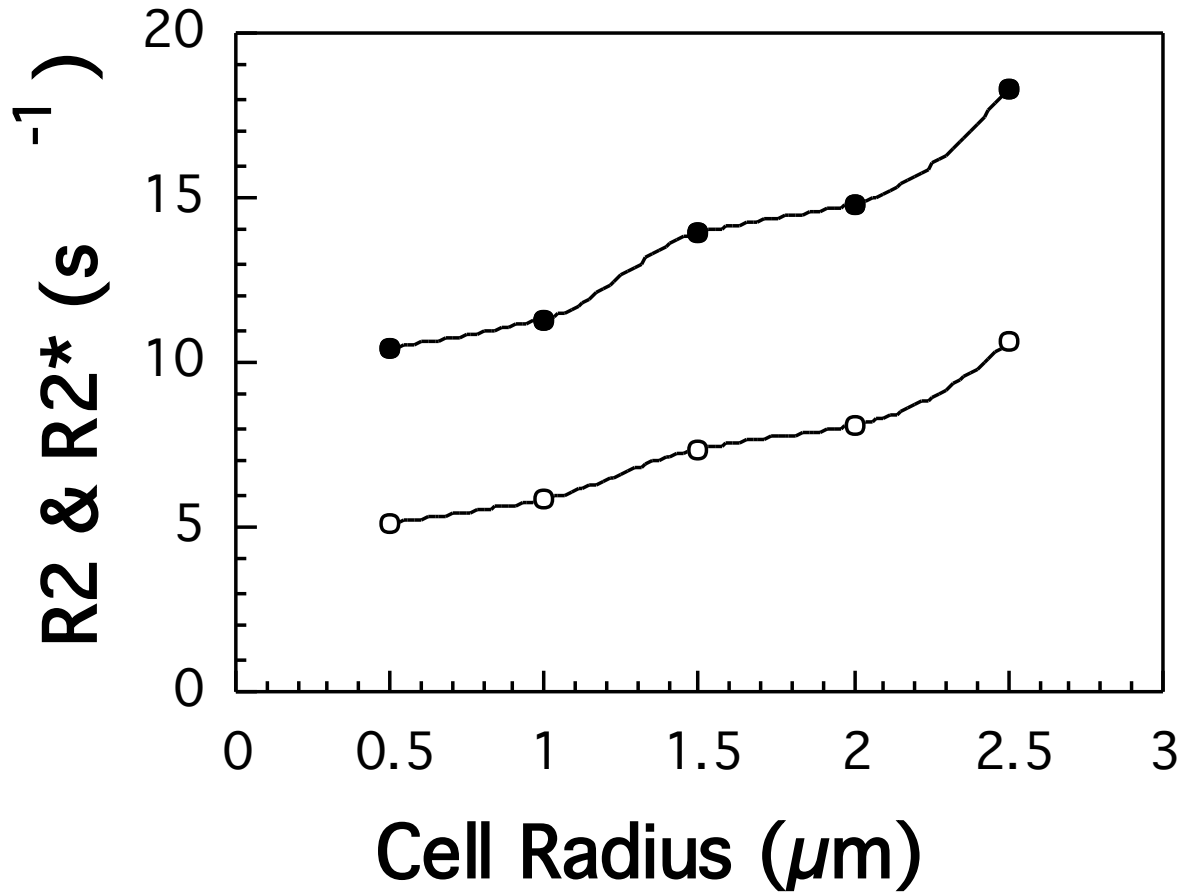

Hct = 44, $\tau = 48$, %HbO₂ = 60, $R2_o = 4.0 \text{ s}^{-1}$, $R2'_o = 8.3 \text{ s}^{-1}$

Relative T2* and T2 dependence on %HbO₂

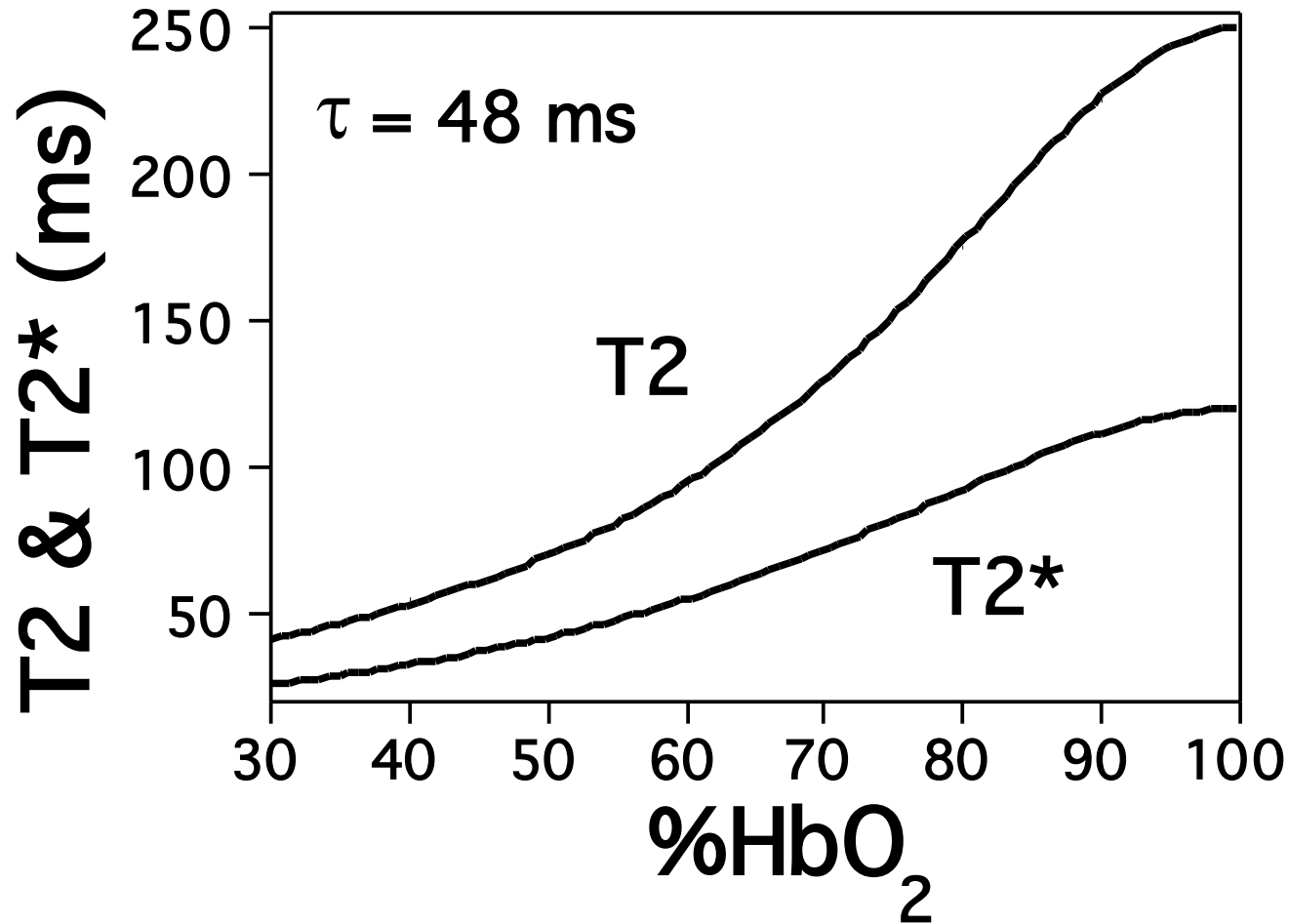

Hct = 44, $D = 1.8 \mu\text{m}^2 / \text{ms}$, $T2_0 = 250$ ms, $T2'_0 = 120$ ms

$$\Delta R2^* / \Delta R2$$

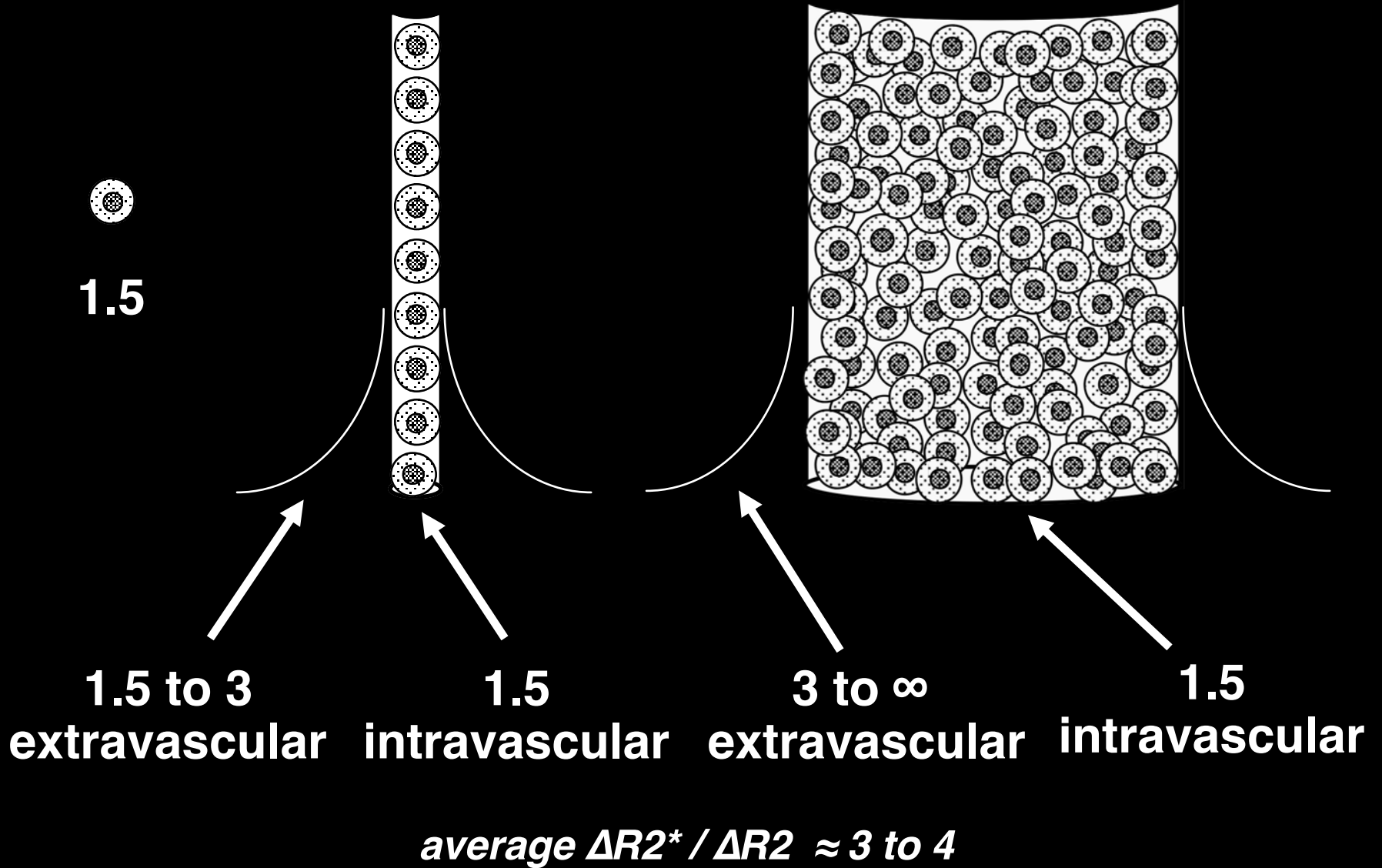

Hematocrit Effect Relaxation Rate Changes with and Oxygenation Change

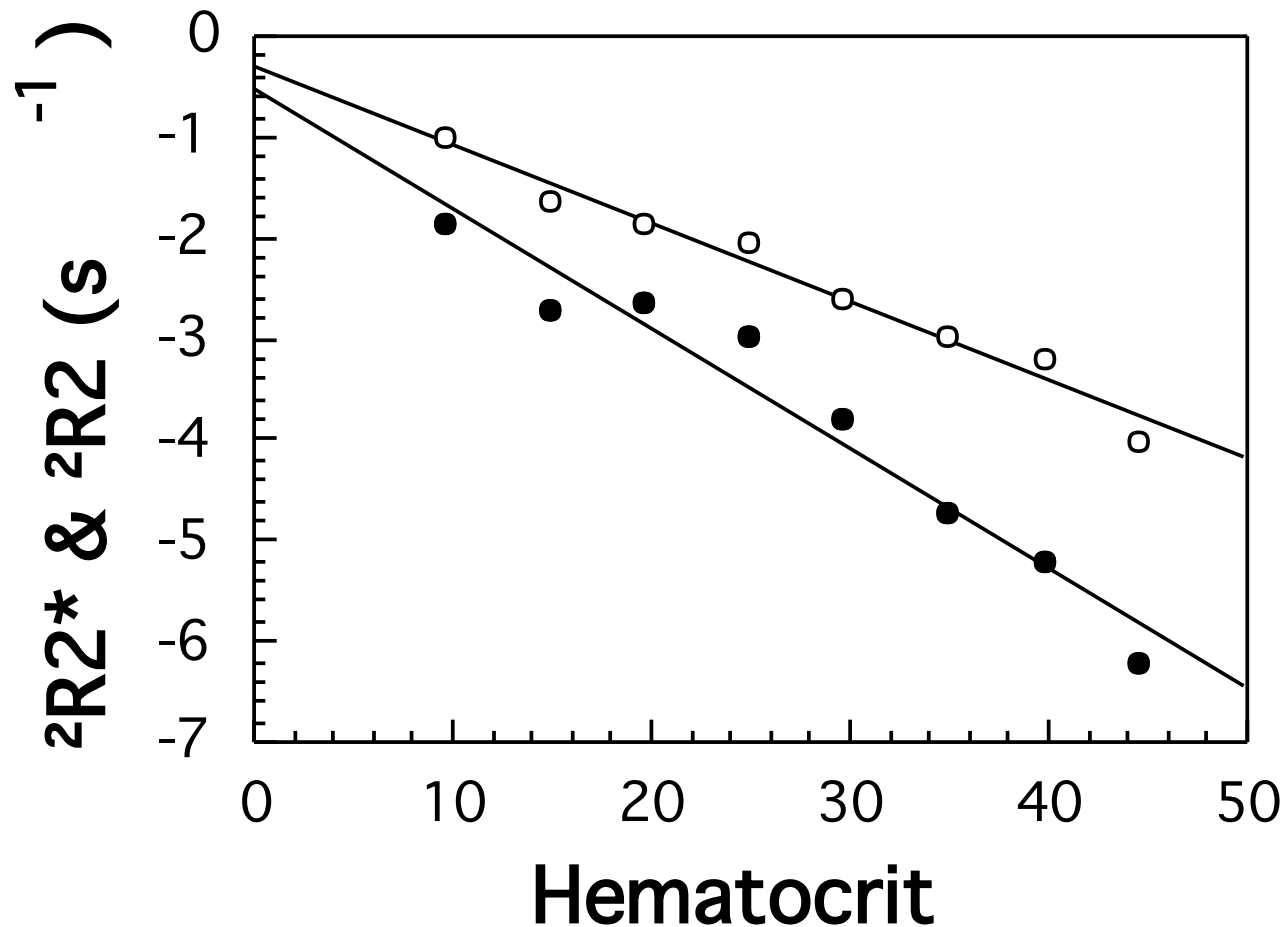

$\tau = 48, \%HbO_2 = 60 \rightarrow 75$

**Numerical Simulations of the Oxygenation
Dependence of the T2 and T2* of Whole Blood
using a Deterministic Diffusion Model**

P. A. Bandettini ¹ J. L. Boxerman ^{1,2} E. C. Wong ³

R. M. Weisskoff ¹ and B. R. Rosen ¹

¹ Massachusetts General Hospital - NMR Center

² Harvard - MIT Division of
Health Sciences and Technology

³ University of California - San Diego

Activation-induced MR Signal Change Mechanisms

T1
Inflow

T2

T2*

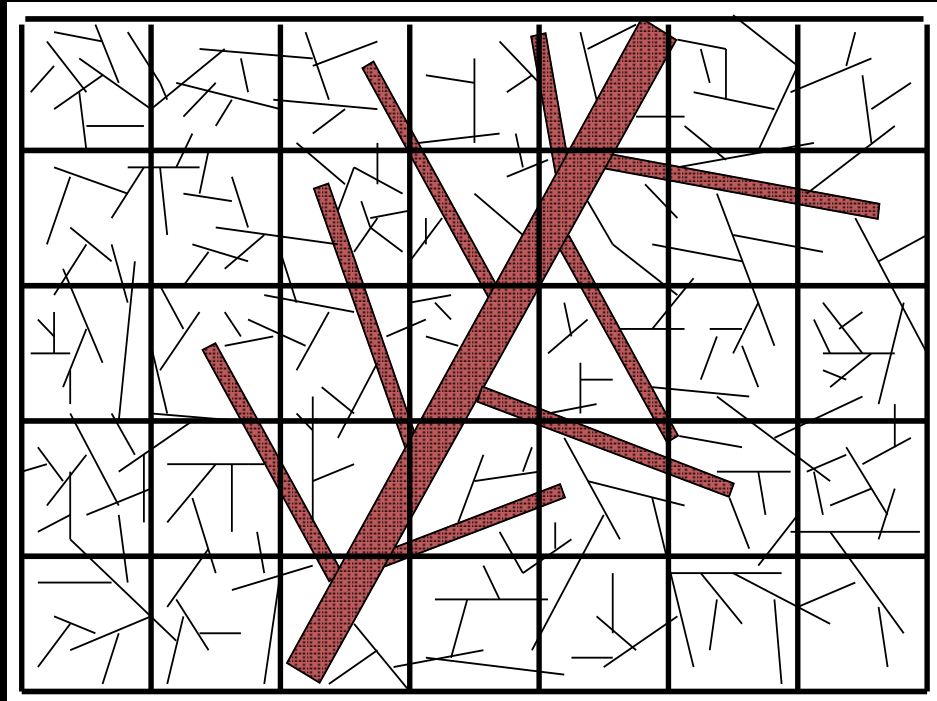

• compartment sizes	2.5 μ m -> 380 μ m
• proton dynamics	Diffusion, Exchange, Flow, Pulsation
• orientation	Random -> Single Orientation
• oxygen saturation	0.6 -> 0.95
• volume	2% -> 100% (per voxel)
• hematocrit	10 -> 50

also

relative intravascular and extravascular effects

Intravascular and Extravascular T2* Effects

vessel in tissue

red blood cells in vessel

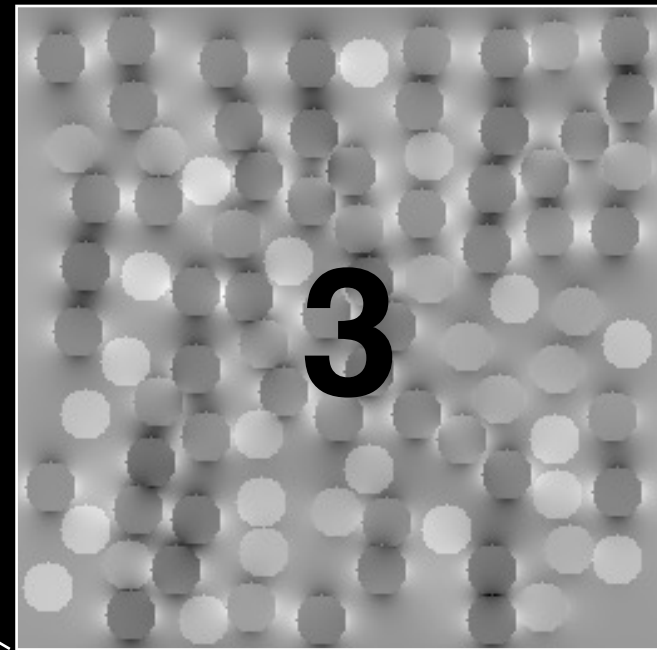
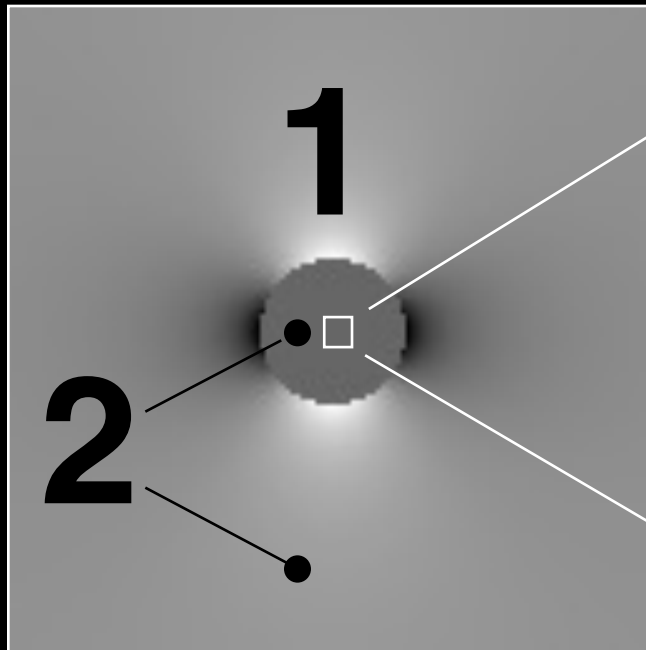

$\Delta\omega$ maps

Intravascular and Extravascular T2* Effects

1. extravascular dephasing

2. intravascular / intravascular dephasing

3. intravascular dephasing

|

(*dependent on the T2* of blood*)

Blood T2

- Thulborn et al. Biochim Biophys Acta, 714: 265-270, 1982
- Gomori et al. JCAT, 11: 684-690, 1987
- Wright et al. JMRI, 1: 275-228, 1991
- Ogawa et al. MRM, 29: 205-210, 1993
- Gilles et al. MRM 33: 93-100, 1995
- Brooks et al. JMRI 4: 446-450, 1995
- Meyer et al. MRM 34: 234-241, 1995

Blood T2* ?

Most fMRI is performed using gradient-echo sequences.

Calculating T2* of Fully Oxygenated Blood

Assumption:

T2' of fully oxygenated blood \approx T2' of cortex

T2' of cortex:

$$1 / T2' = 1 / T2^* - 1 / T2 \approx 1 / 60 \text{ ms} - 1 / 80 \text{ ms} \approx 1 / 240 \text{ ms}$$

T2* of fully oxygenated blood (at 1.5T):

$$1 / T2^* \approx 1 / T2' + 1 / T2 \approx 1 / 240 \text{ ms} + 1 / 250 \text{ ms} \approx 1 / 120 \text{ ms}$$

Basic Approach

1. Simplified model based on literature values.

Physiologic:

hematocrit
oxygenation
geometry
susceptibility

MR:

inter-180 time
field strength

3. Adjust *diffusion coefficient* to “match” results of:

•Wright et al. JMRI, 1: 275-228, 1991 (T_2)

and

•Hoppel et al. MRM, 30: 715-723, 1993 ($\Delta R_2^* / \Delta R_2$)

4. Using matched parameters, simulate T_2^* effects.

Deterministic Diffusion Model

Frequency Offset

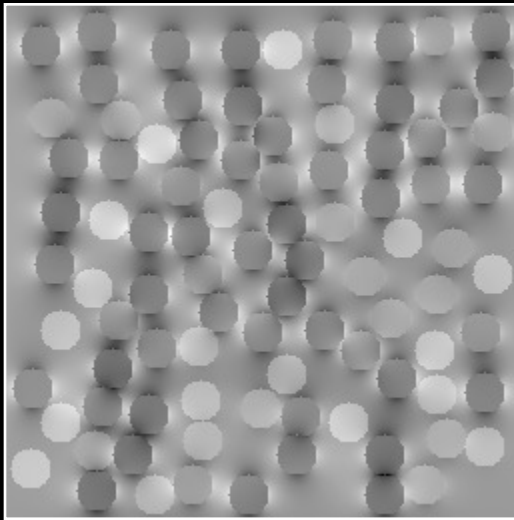

- Randomly oriented cylinders
- Freely permeable
- Overlapping fields
- Red blood cell radius:
($2.5 \mu\text{m} = 10 \text{ voxels}$)
- Hct. determines number of cells

Spin Probability Distribution

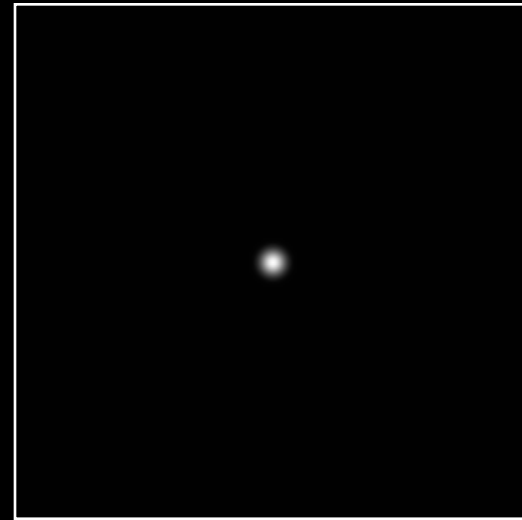

- Gaussian distribution
- Step time increment:
(0.1 ms to 0.25 ms)

$$\text{prob}(x,y) = \left(\frac{LX_x LY_y}{2\pi\sigma^2} \right) \frac{1}{\sigma^2} e^{-\left(\frac{x^2 + y^2}{2\sigma^2} \right)}$$

$$\sigma = \sqrt{2Dt}$$

matrix sizes = 256 x 256 voxels

Frequency Offset Map

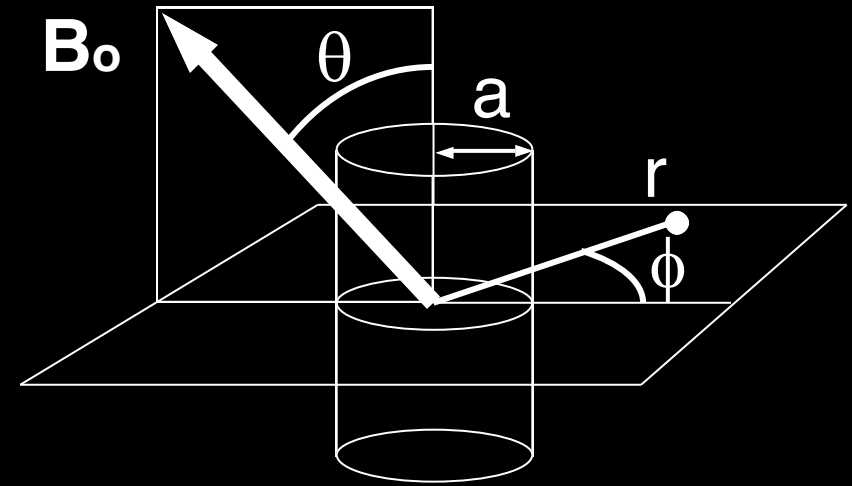

$$\Delta\omega' = 2\pi [(42.57 \times 10^6) 2\pi B_0] [\Delta\chi] (1 - Y)$$

$$\Delta\chi = 0.180 \times 10^{-6} \text{ rbc}$$

$$\Delta\omega \text{ (outside)} = \Delta\omega' \sin^2(\theta) (a/r)^2 \cos(2\phi)$$

$$\Delta\omega \text{ (inside)} = \Delta\omega' (3 \cos(\theta) - 1)^2 / 3$$

S. Ogawa et al.

Biophys J. 64, 803-812 (1993).

Spin Probability Distribution

$$\text{prob}(x,y) = \left(\frac{LX \times LY}{2\check{s}} \right) \frac{1}{\sigma^2} e^{-\left(\frac{x^2 + y^2}{2\sigma^2} \right)}$$

$$\sigma = \sqrt{2Dt}$$

$$D \text{ (pixels}^2/\text{ms)} = \frac{D \text{ (}\mu\text{m}^2/\text{ms)}}{\left(\frac{\text{cell radius (pixels)}}{\text{cell radius (}\mu\text{m)}} \right)^2}$$

$x (TE/dt)$

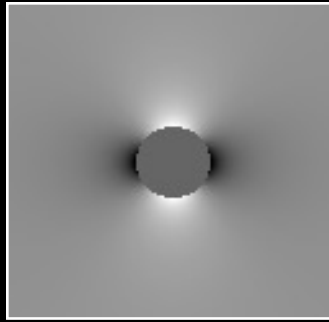

$\Delta\omega$ map

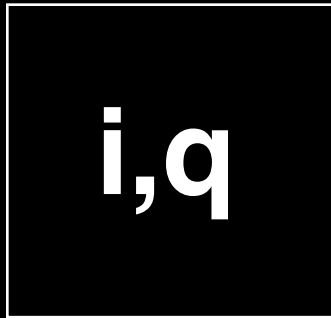

magnetization

$$\mathbf{x} \begin{vmatrix} \cos(\Delta\omega dt) & \sin(\Delta\omega dt) \\ -\sin(\Delta\omega dt) & \cos(\Delta\omega dt) \end{vmatrix} *$$

rotation matrix

"phase rotate"

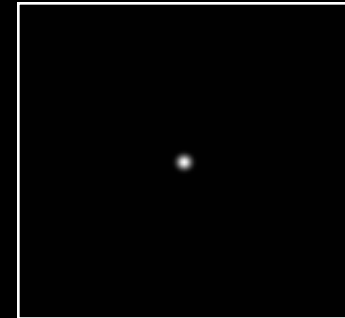

smoothing function

"smooth"

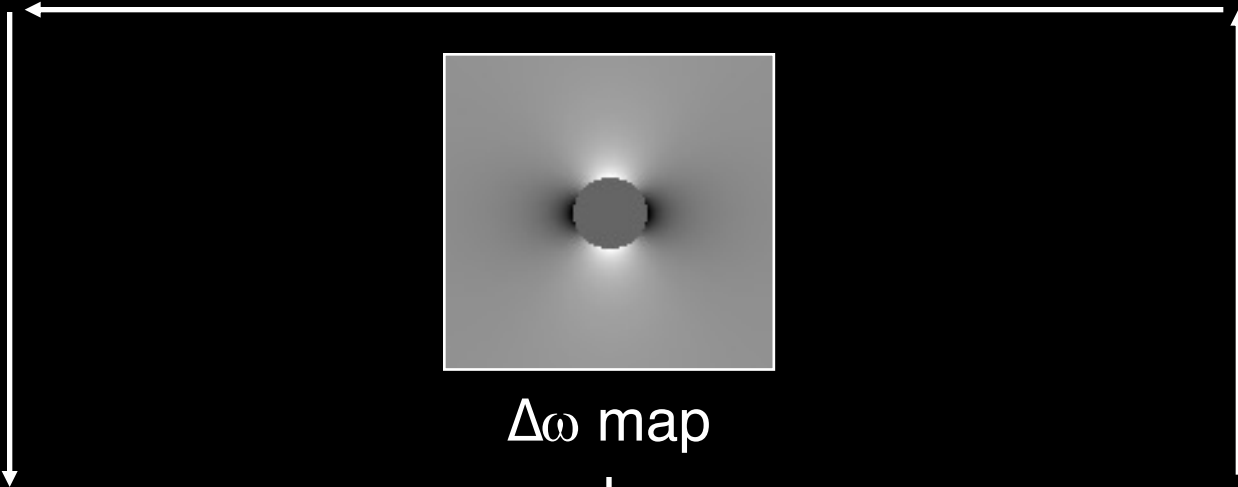

"Phase Rotate" and "Smooth" Simulation

- 1) Start with maps of uniform, coherent transverse magnetization ($i = 1, q = 0$).
- 2) For each time interval, dt , perform:
 - a) Spatially - dependent phase rotation.
(using $\Delta\omega$ maps)
 - b) Convolution with gaussian smoothing function.
(representing diffusion during time, dt)
 - c) Signal magnitude calculation by complex addition of every matrix element.

Gradient-Echo

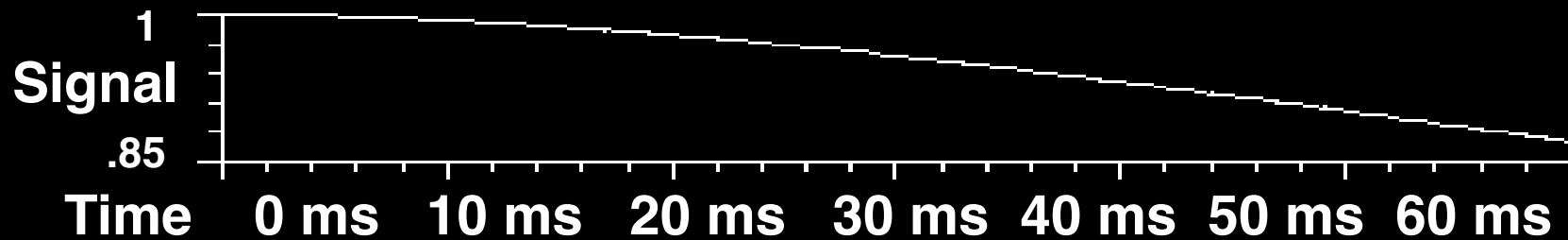
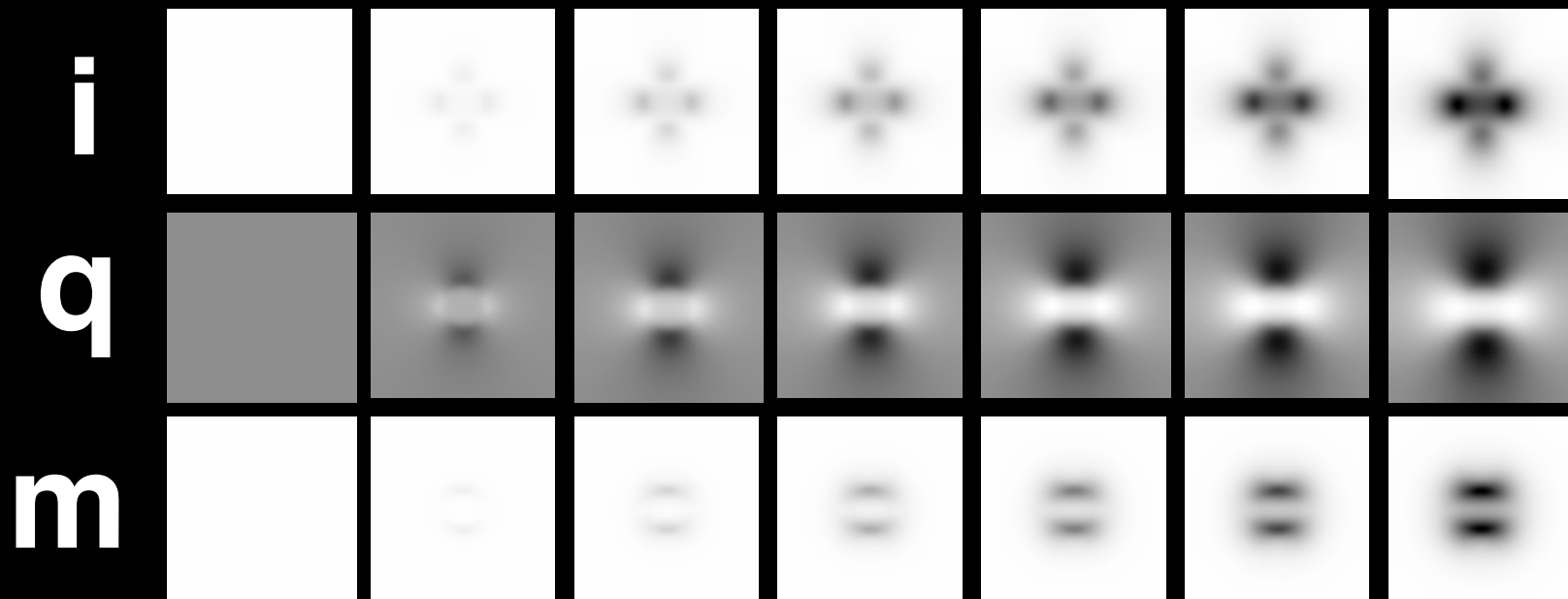
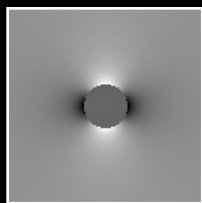

Spin-Echo

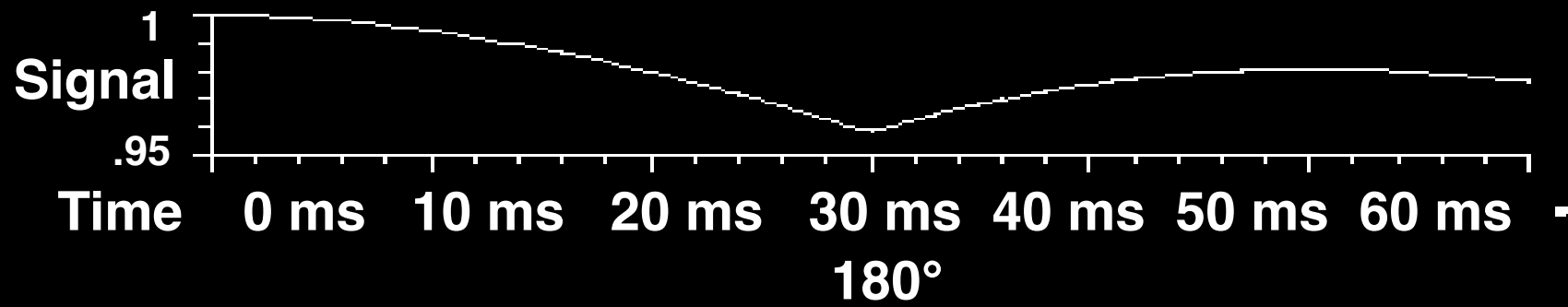

$x (TE/dt)$

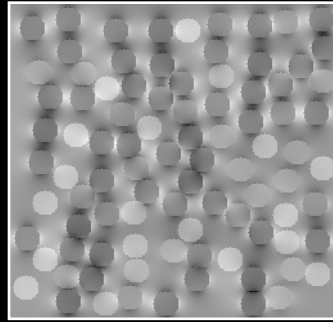

$\Delta\omega$ map

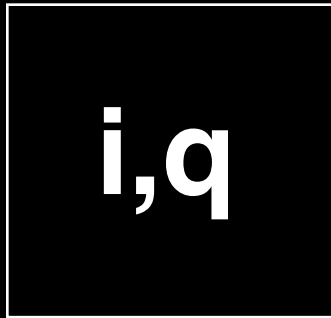

magnetization

$$\mathbf{x} \begin{vmatrix} \cos(\Delta\omega dt) & \sin(\Delta\omega dt) \\ -\sin(\Delta\omega dt) & \cos(\Delta\omega dt) \end{vmatrix} *$$

rotation matrix

"phase rotate"

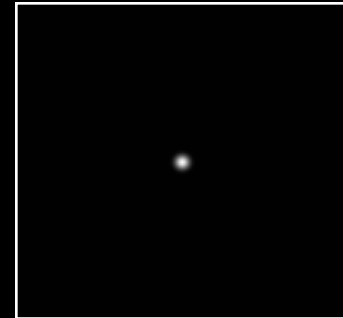

smoothing function

"smooth"

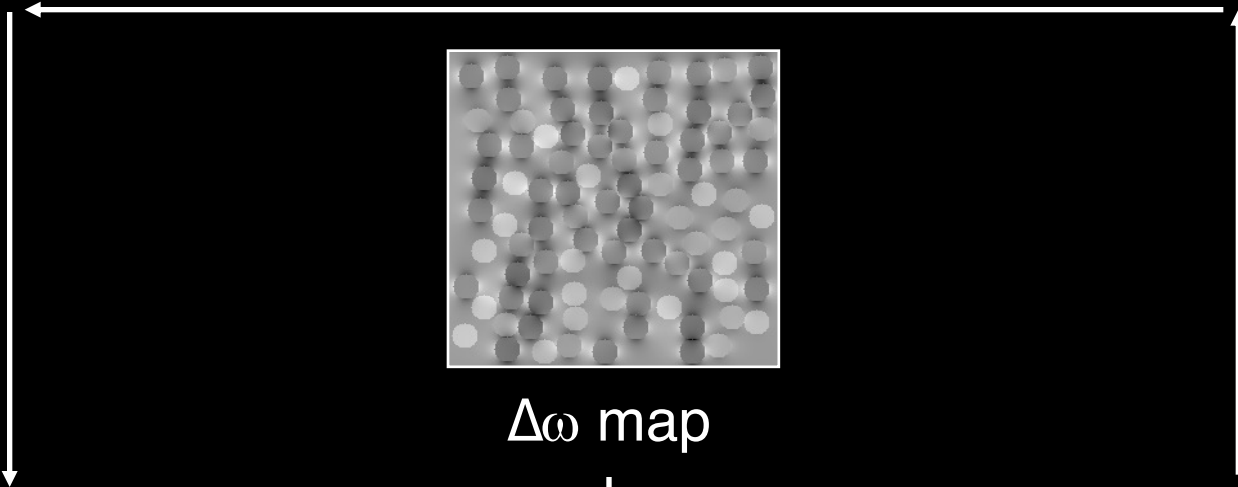

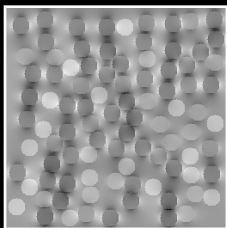

Spin-Echo

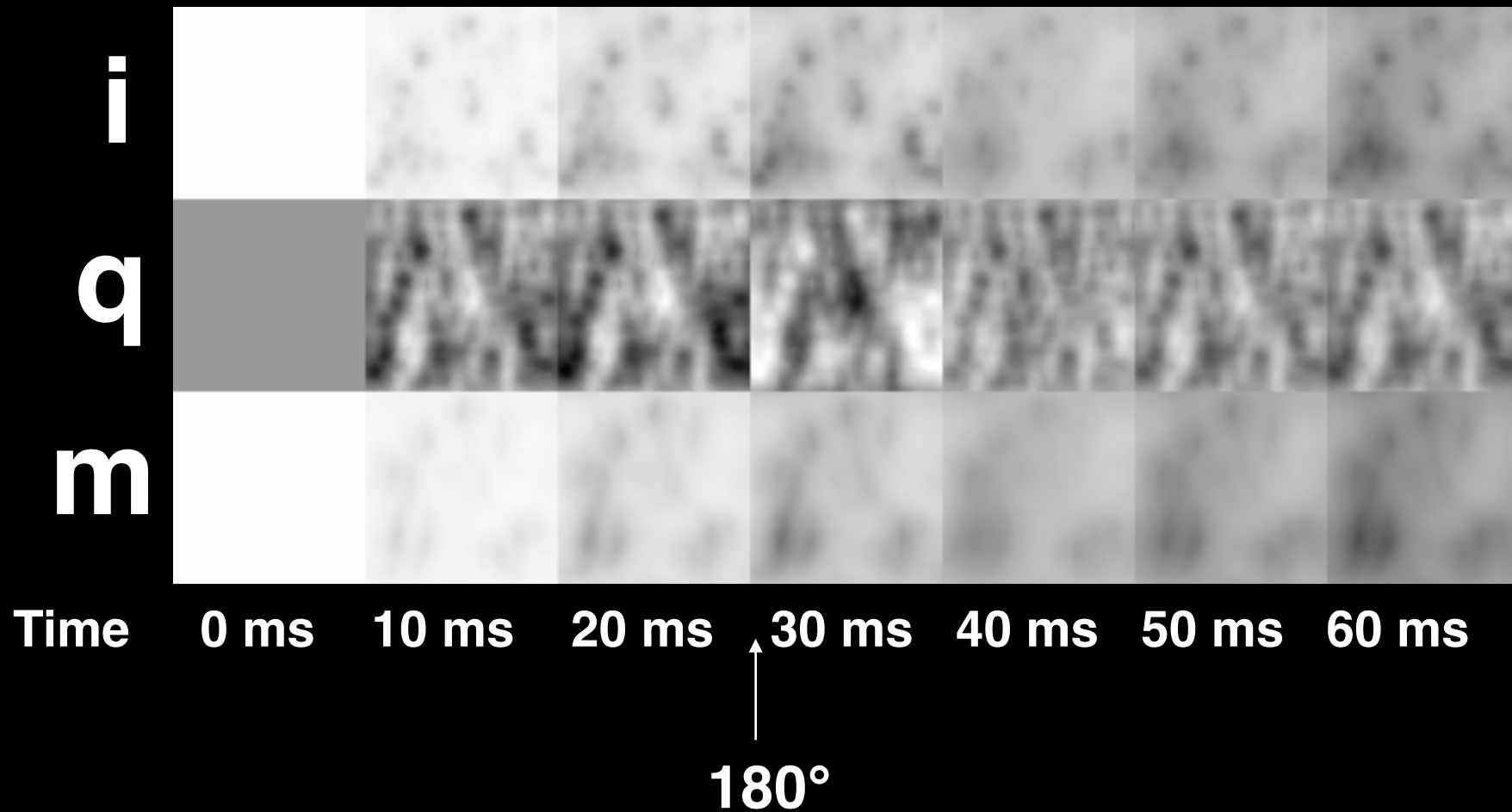

GE

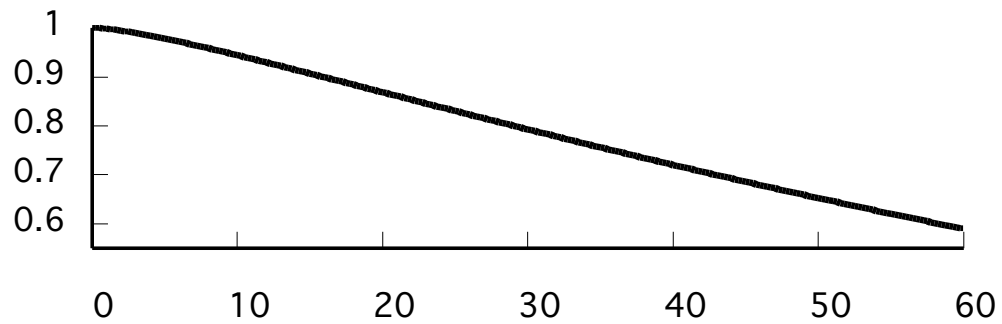

SE

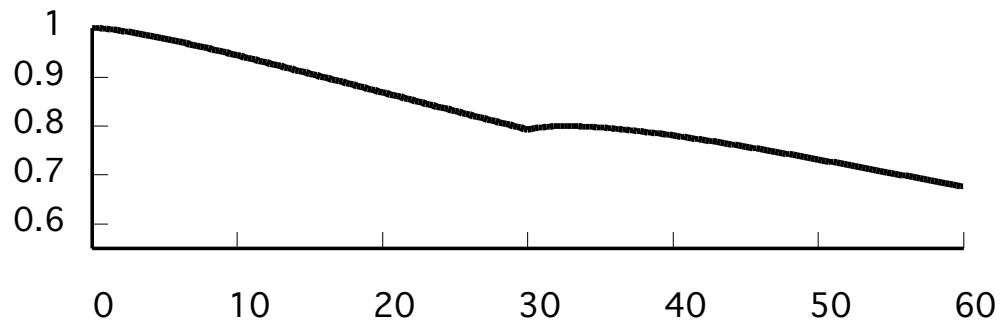

Comparison #1

- Wright et al. JMRI, 1: 275-228, 1991
- **Hct = 44**
- **Field Strength = 1.5 T**
- **5 echo measurement**
- **inter-180 time (τ) from 1.5 ms to 48 ms.**
- **T₂ set to 250 ms.**
- **%HbO₂ varied from 30% to 100%**

Simulated Multi - Echo Collection

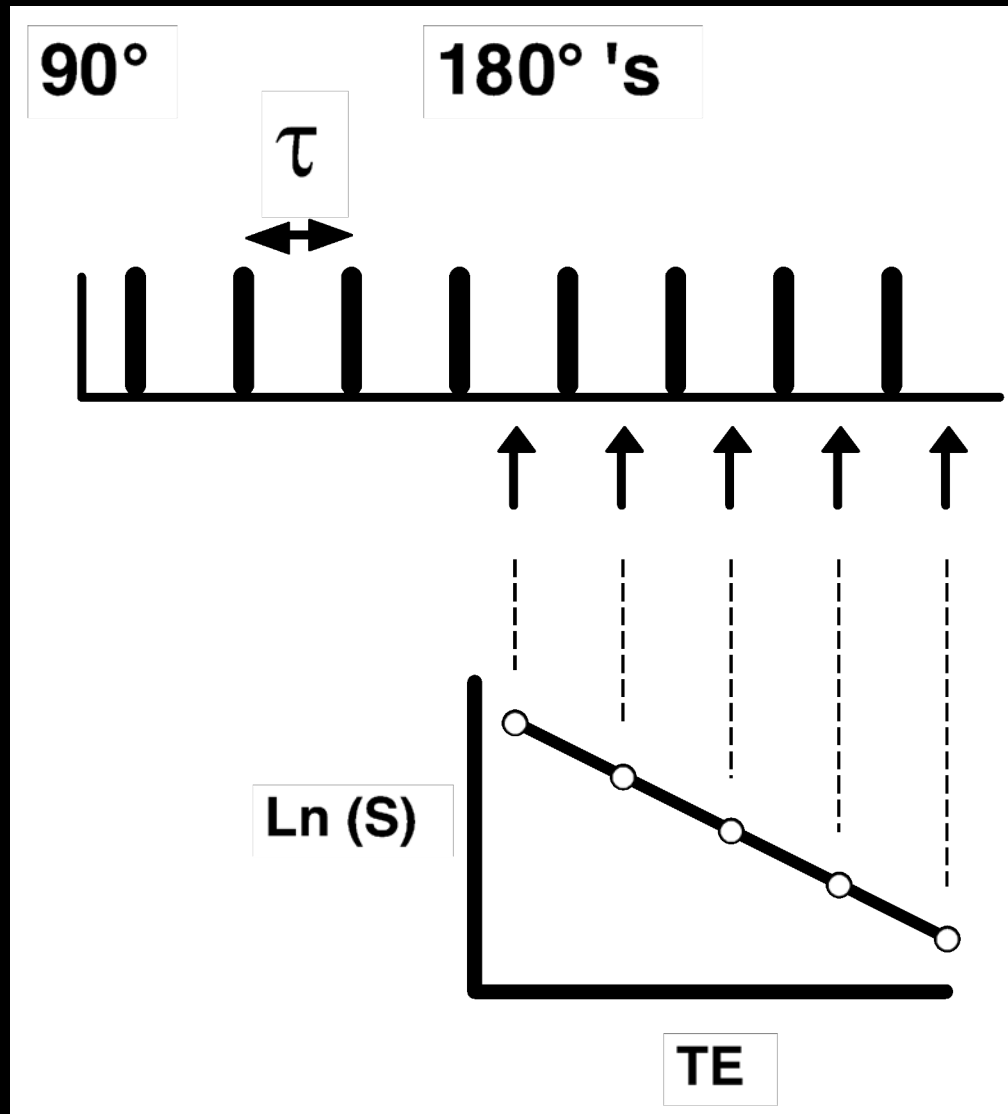

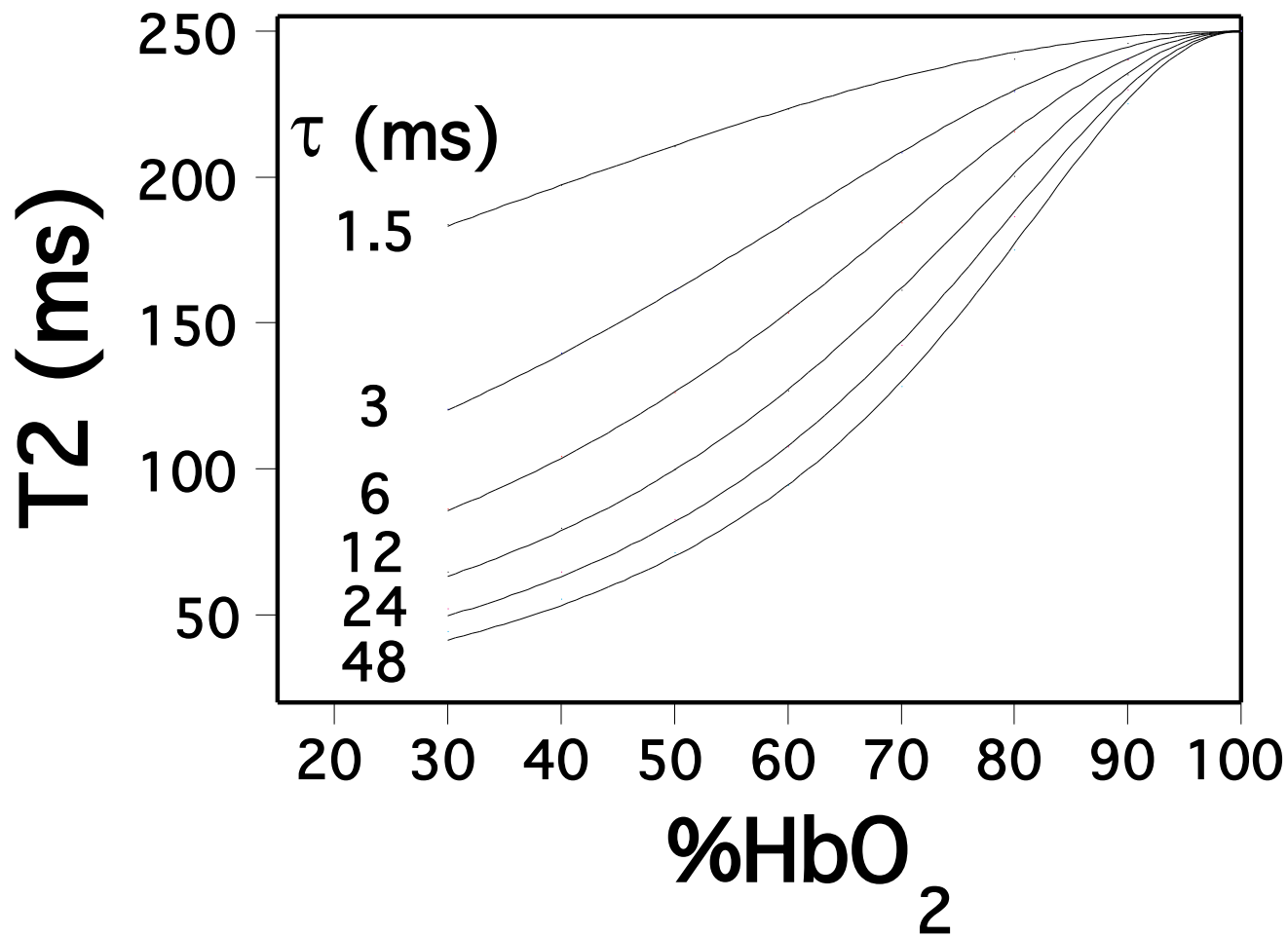

$$D = 1.8 \mu\text{m}^2 / \text{ms}$$

D = 1 $\mu\text{m}^2 / \text{ms}$ \rightarrow 2.5 $\mu\text{m}^2 / \text{ms}$

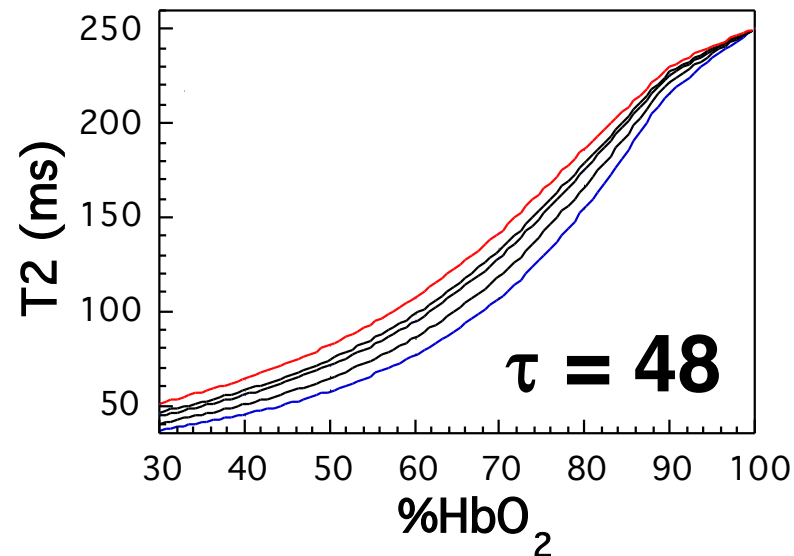
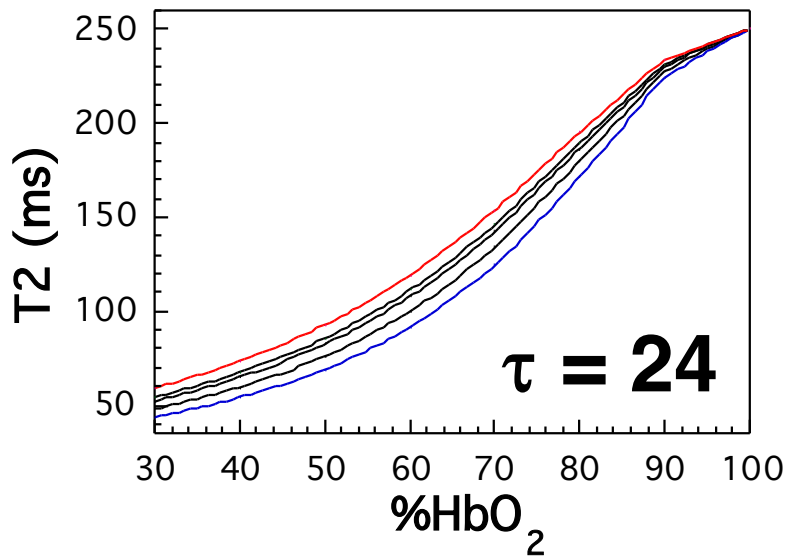
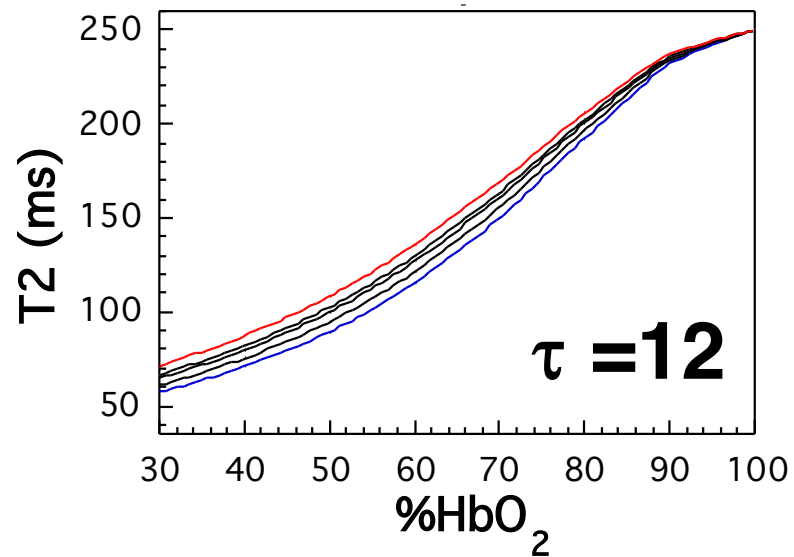
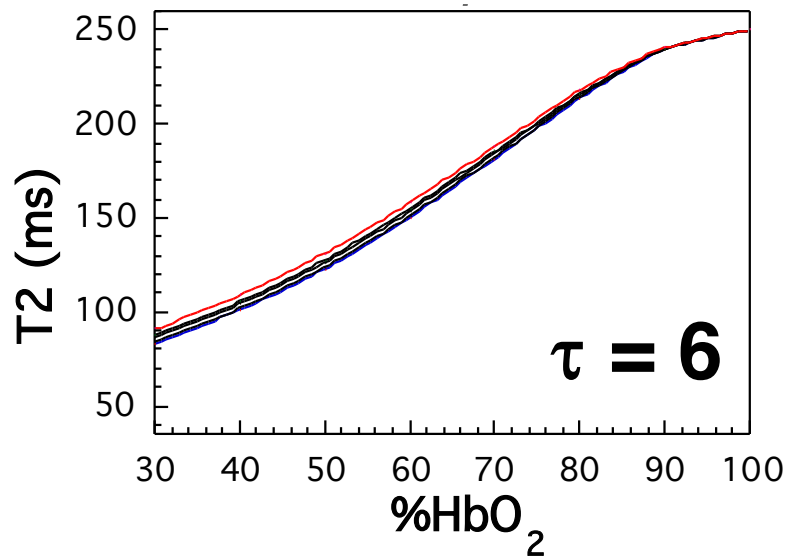

Comparison #2

• Hoppel et al. MRM, 30: 715-723, 1993

- **Hct = 44**
- **Field Strength = 1.5 T**
- **Determine $\Delta R2^*/\Delta R2$**
- **5 echo measurement**
- **Spin-echo: $\tau = 48$ ms.**
- **Gradient-echo: center echo TE = 48 ms.**
- **$\Delta R2^*$ and $\Delta R2$ relating
to %HbO₂ change from 60% to 70%.**

- Large vessel effect not removed by spin-echo.
- FMRI signal change magnitude (for SE and GE) is likely to be most strongly weighted by blood volume in each voxel

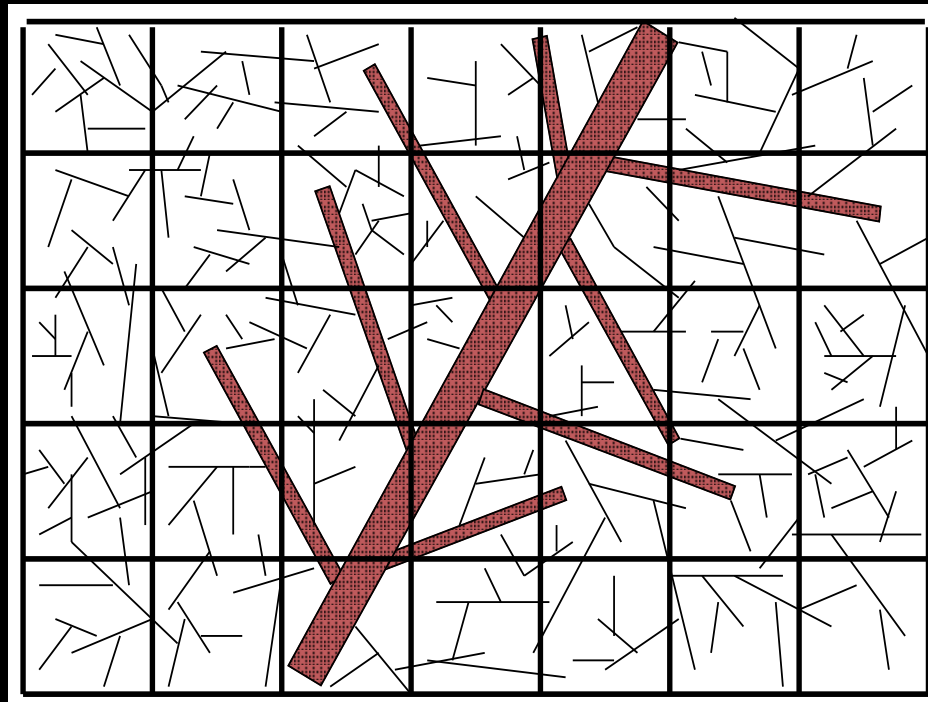

Hct = 44, %HbO₂ = 60, tau = 48 ms

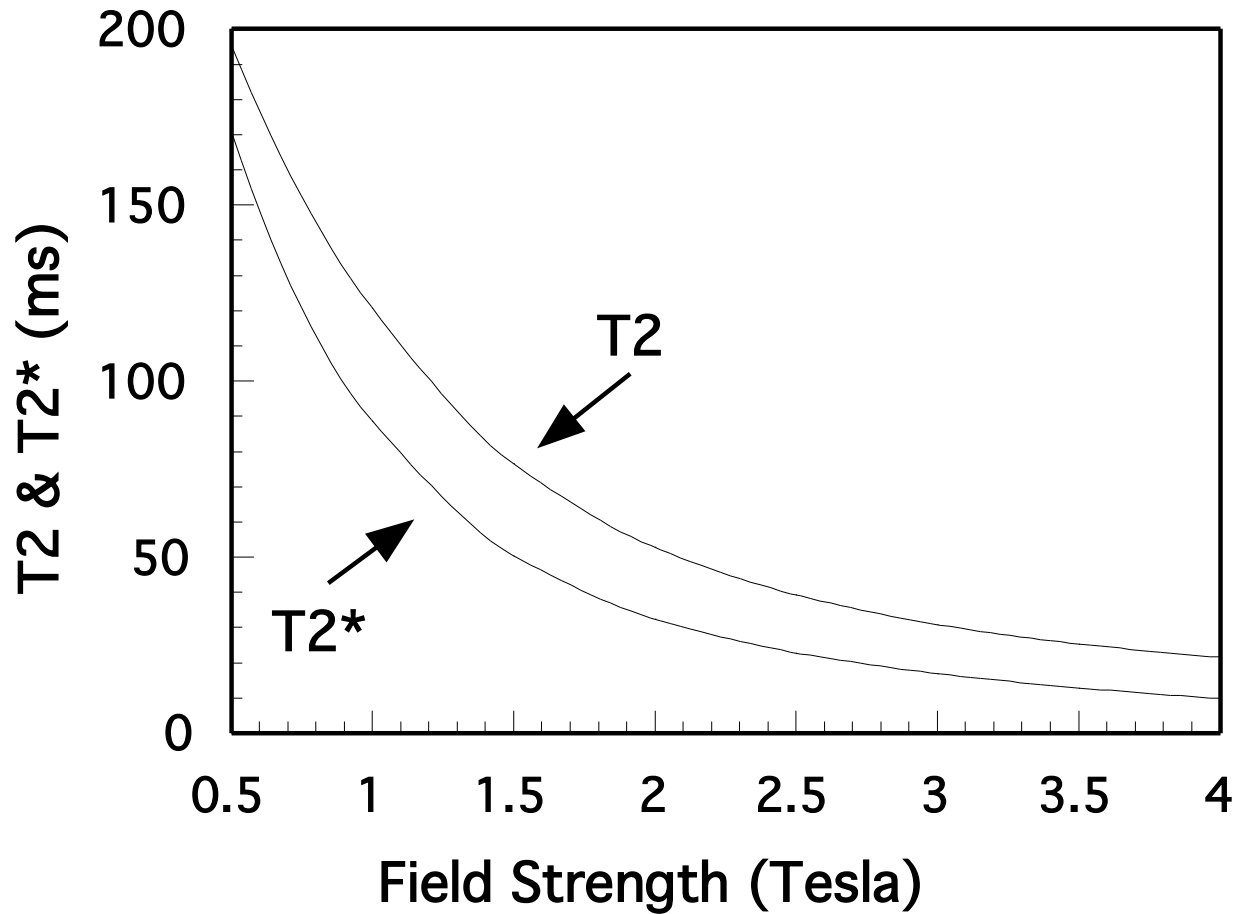

Conclusions

- 1. Intravascular T2* and T2 effects are simulated with a deterministic diffusion model.**
 - simplified geometry and proton dynamics.
 - simplified dephasing mechanism:
(diffusion in, through, and around red blood cells)
- 2. Results show general agreement with literature at $D = 1.8 \mu\text{m}^2 / \text{ms}$ and radius = $2.5 \mu\text{m}$.**
- 3. Because of intravascular effects, spin-echo sequences do not remove large vessel effects.**
- 4. T2* of blood is significant when considering field strength fMRI dependence.**

Red Blood Cell

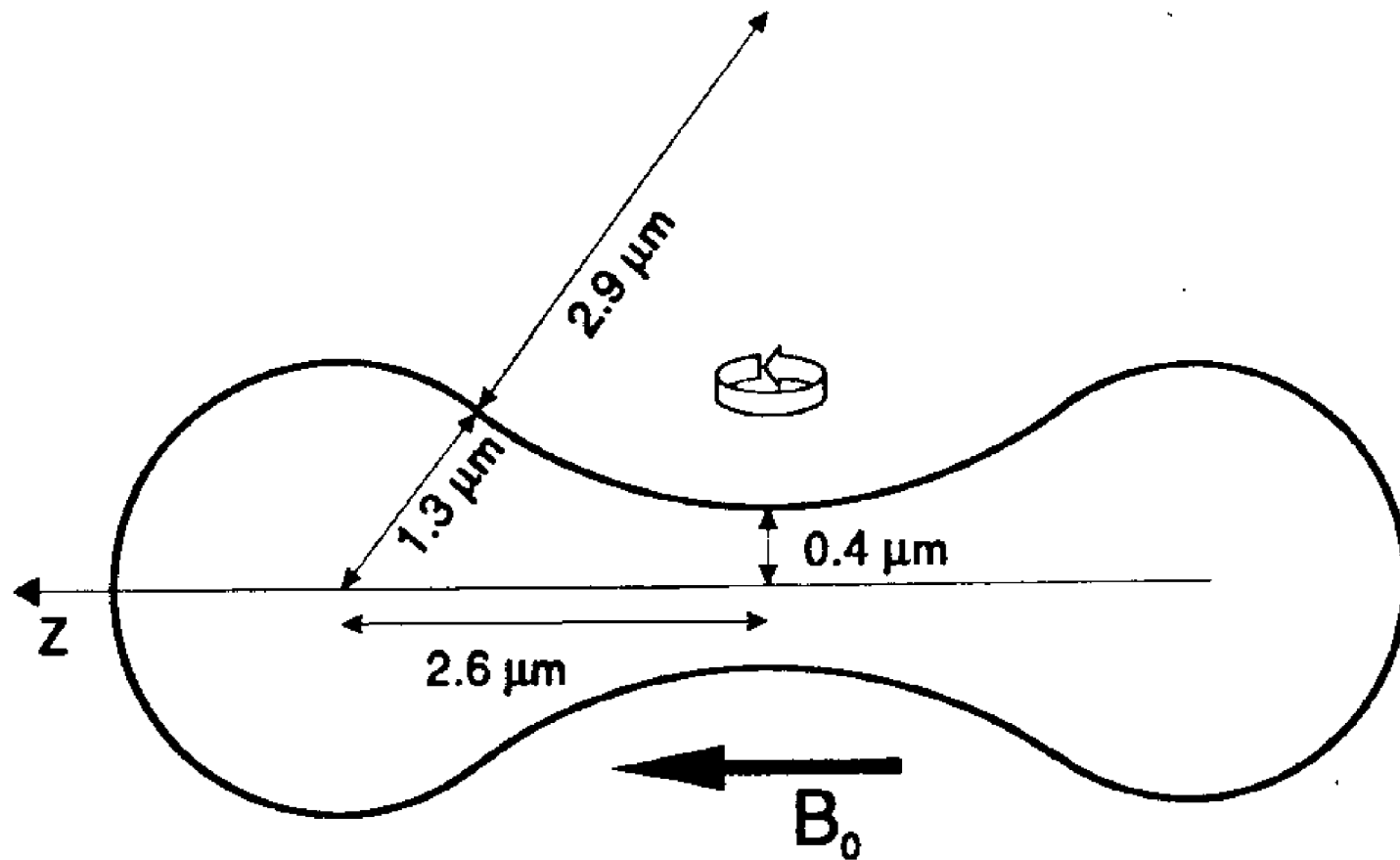

Gilles et al. MRM 33: 93-100, 1995

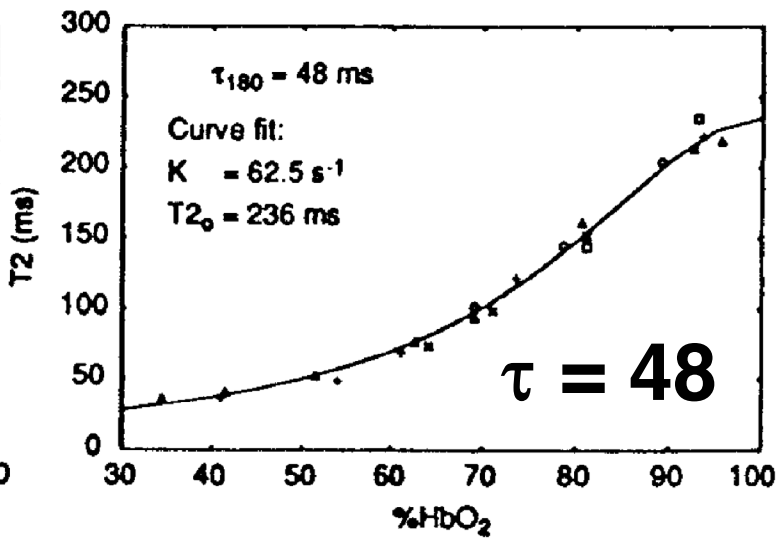
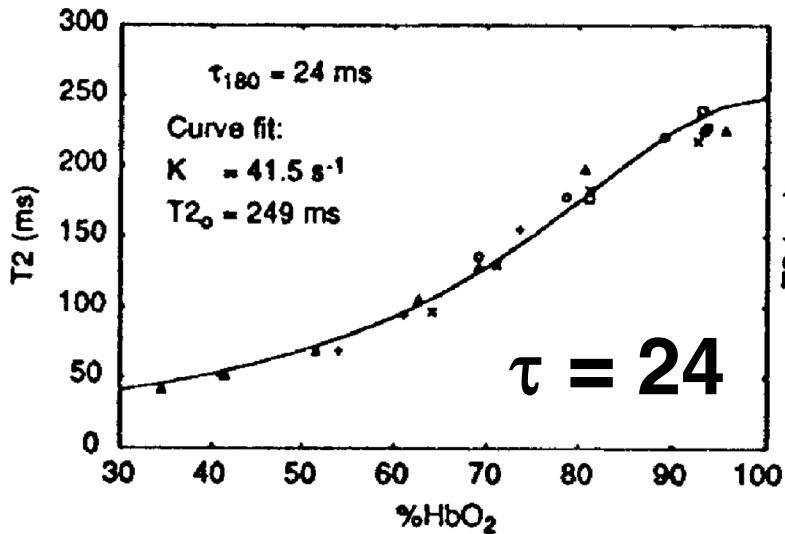
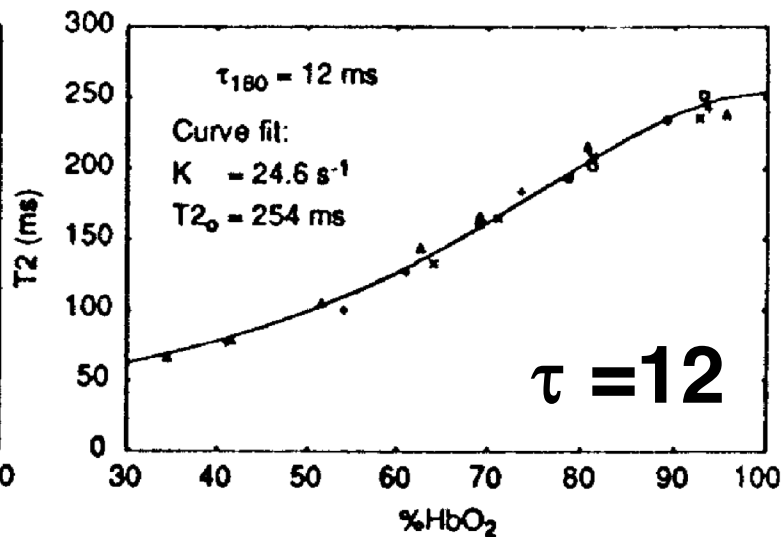
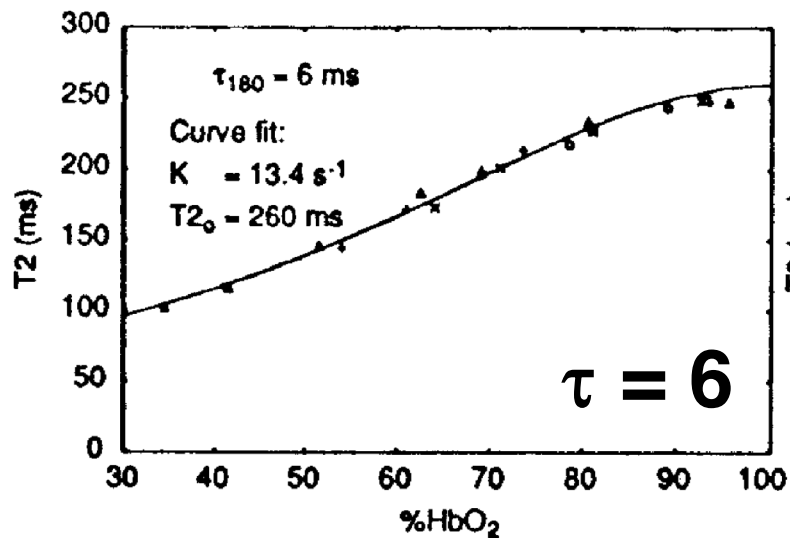

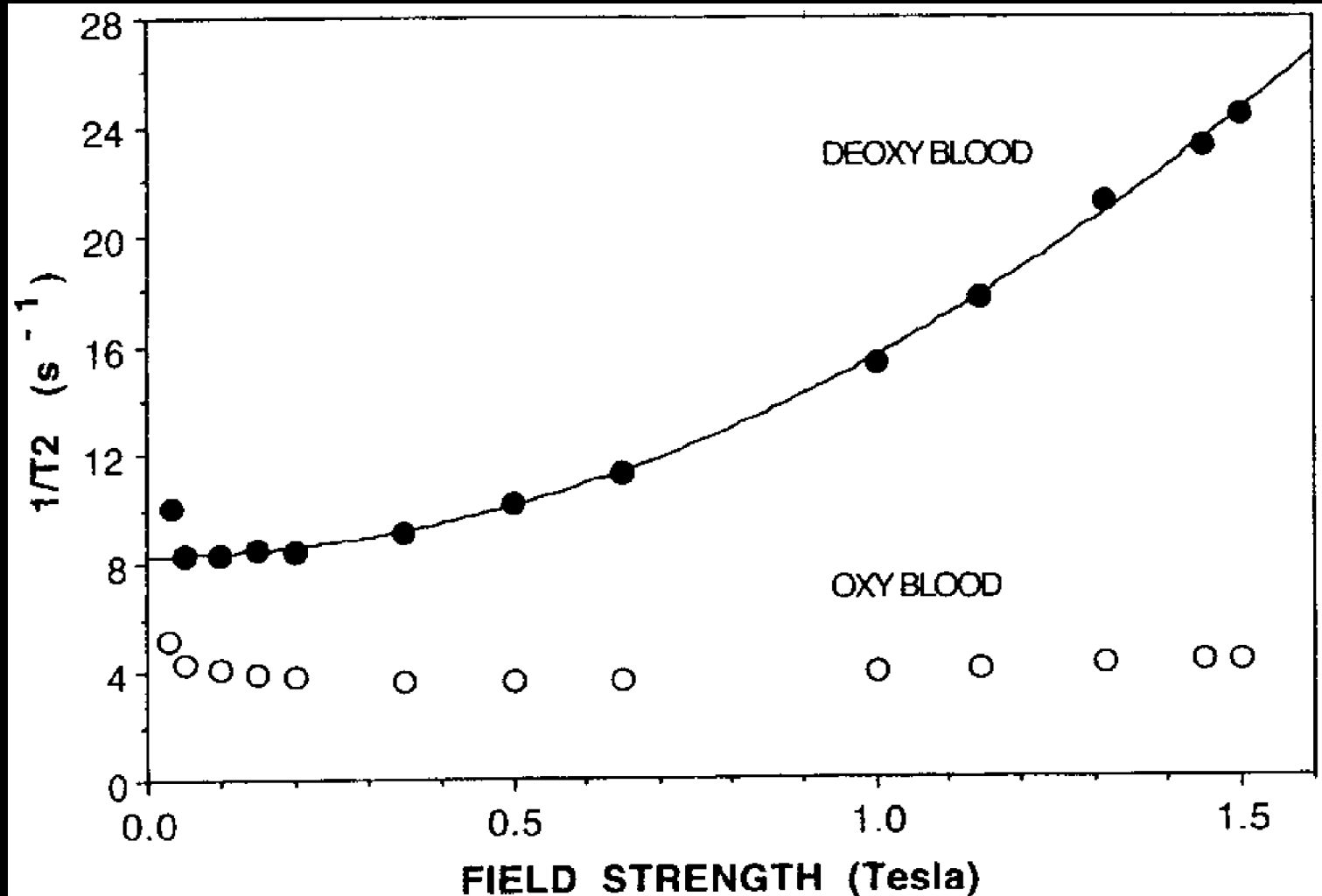

Brooks et al. JMRI 4: 446-450, 1995

Future Work

- **Model the relative intravascular and extravascular effects using the deterministic diffusion model.**
- **Characterize the differences between exchange and diffusion mechanisms.**

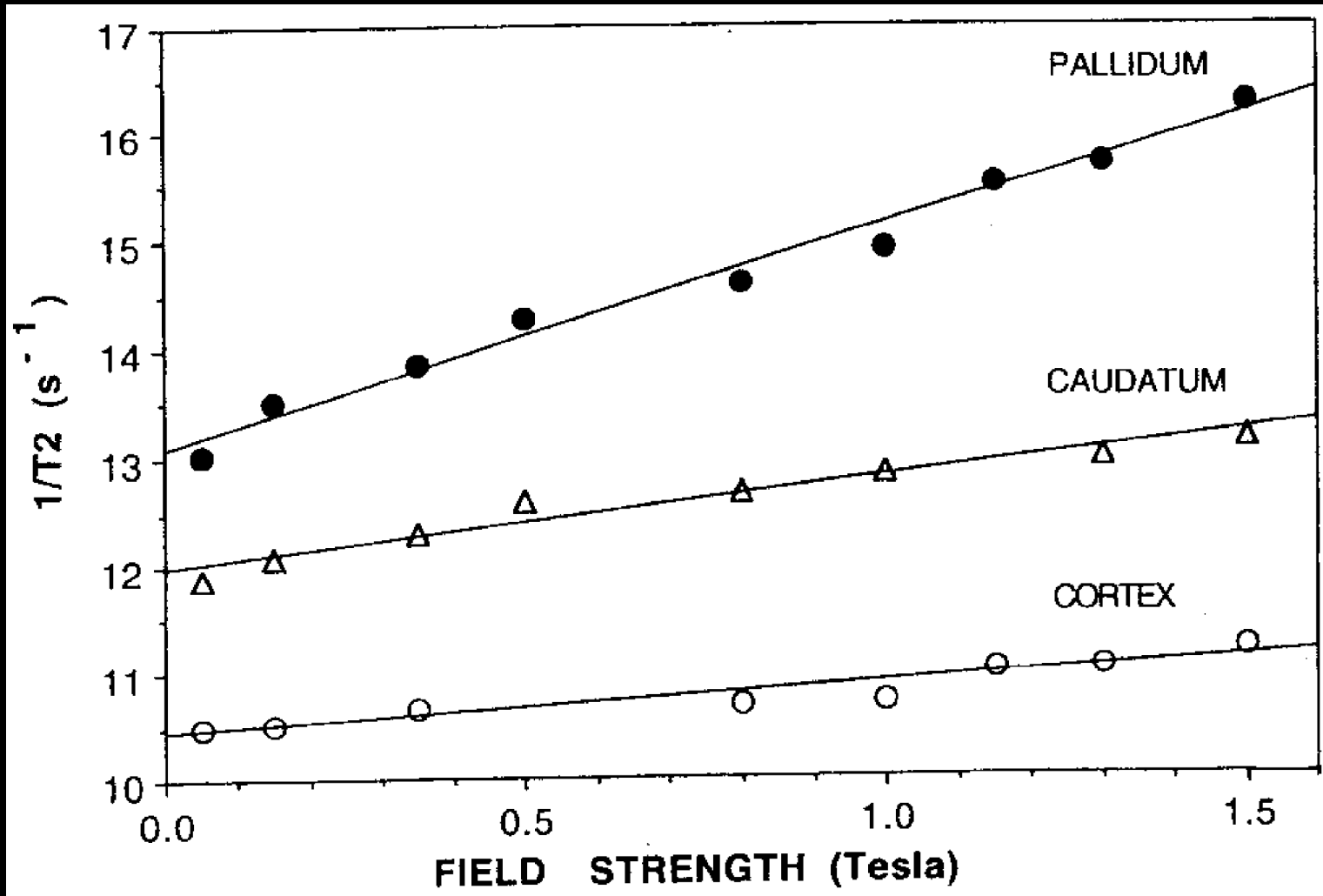

Brooks et al. JMRI 4: 446-450,1995

Red Blood Cell

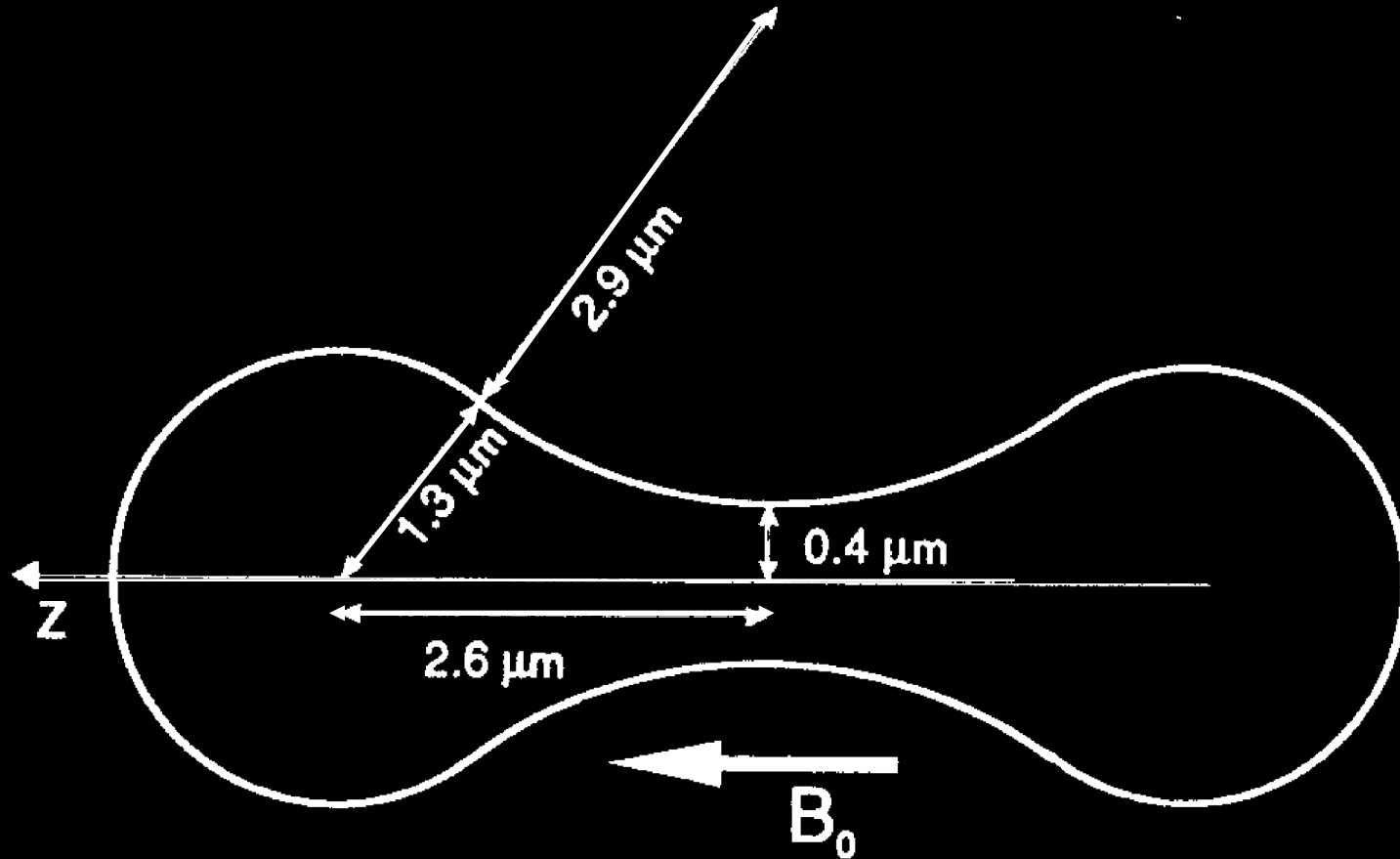

Gilles et al. MRM 33: 93-100, 1995

$$\frac{1}{T2_b} = \frac{1}{T2_o} + K(\tau_{180}, \omega_0) \left(1 - \frac{\%HbO_2}{100\%} \right)^2$$

Luz - Meiboom Model

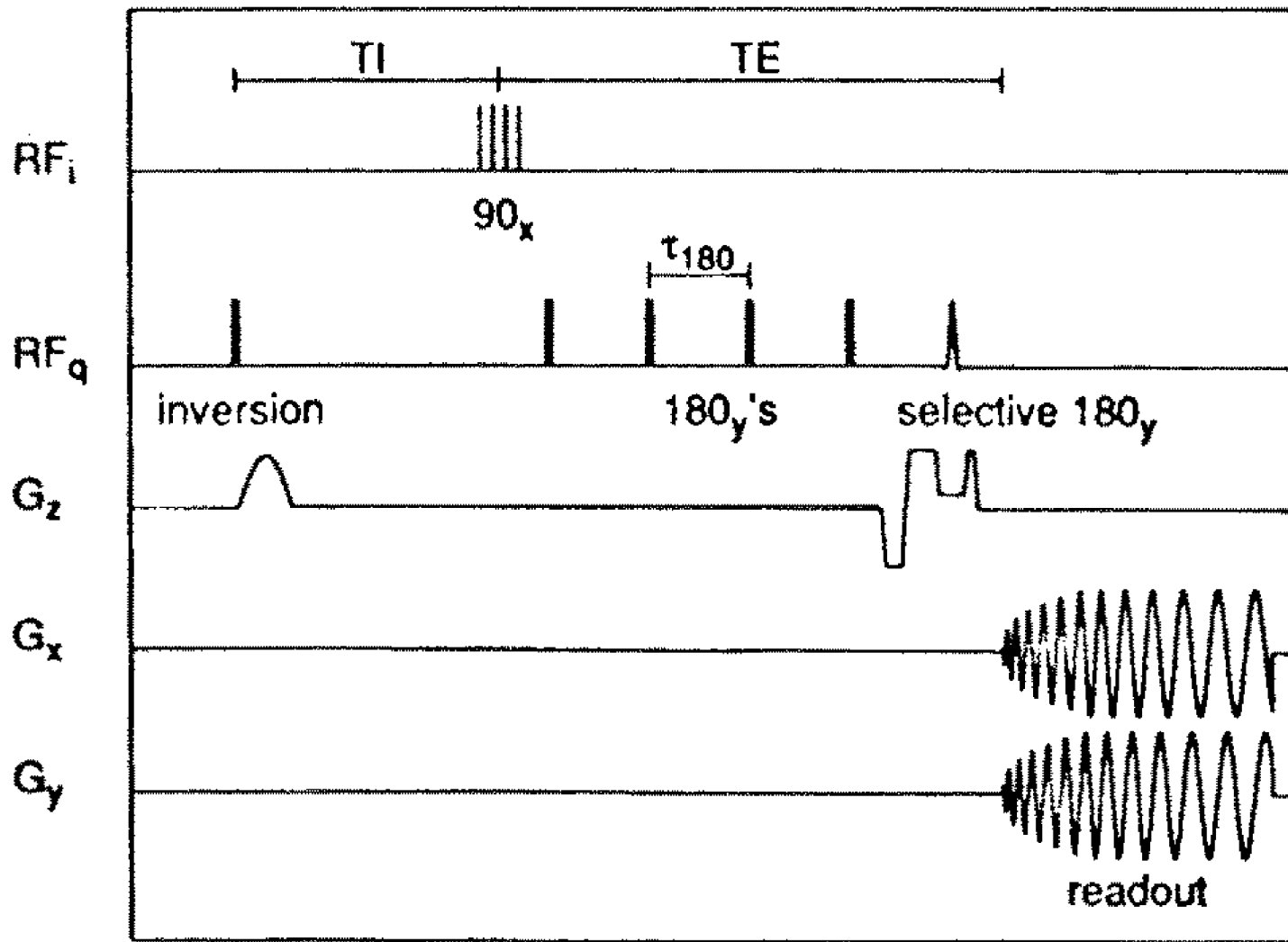

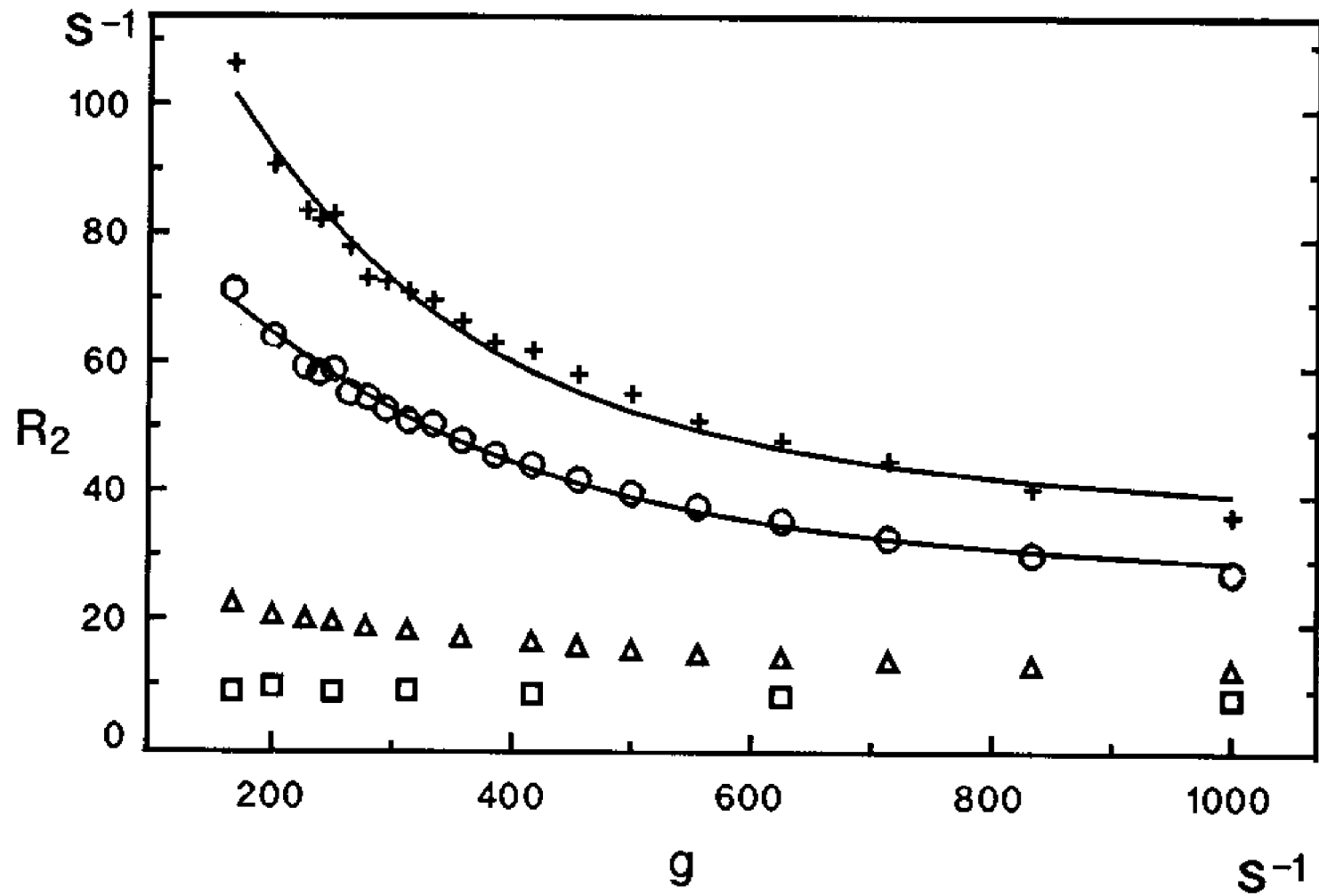

Meyer et al. MRM 34: 234-241, 1995

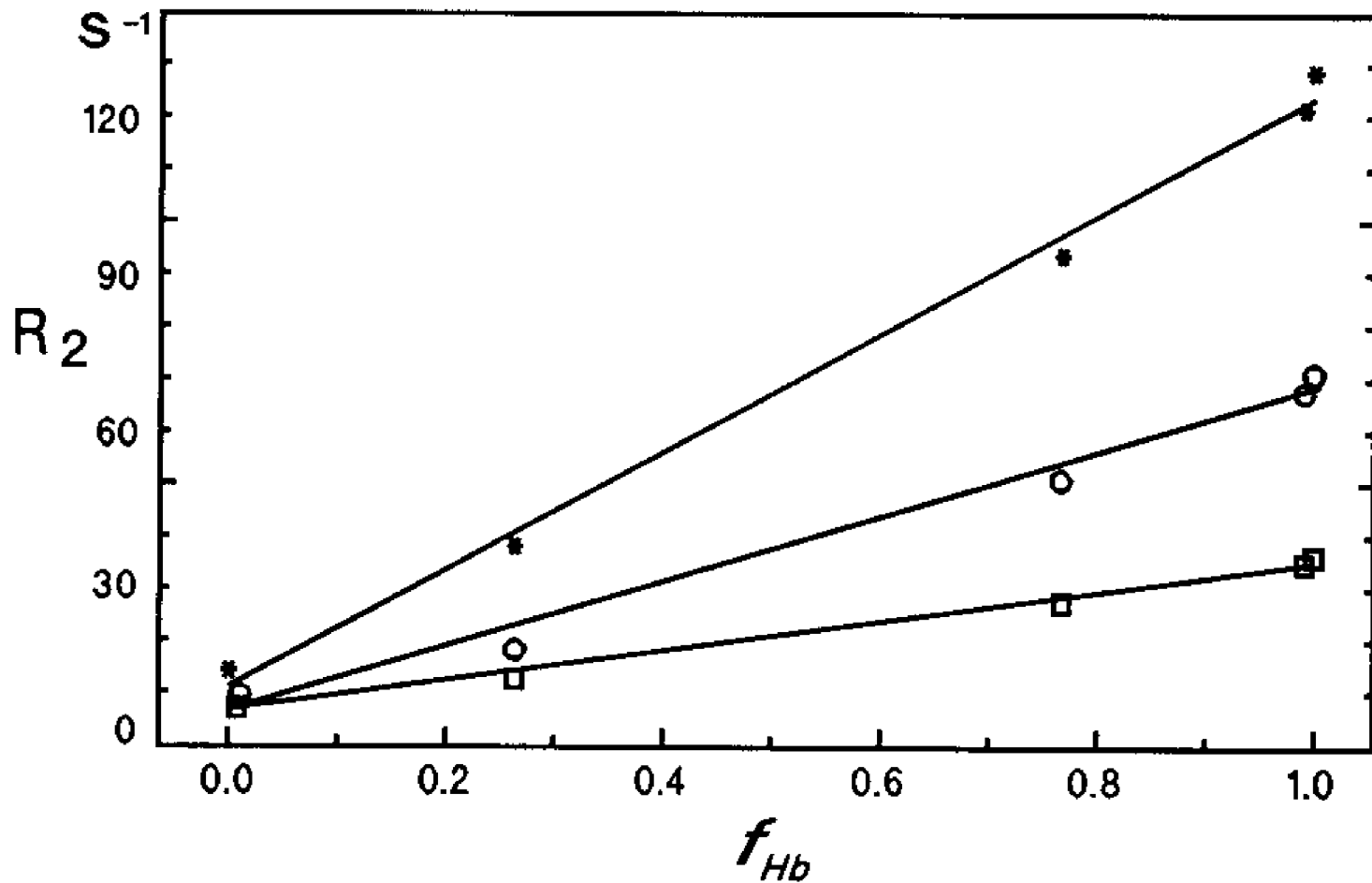

Meyer et al. MRM 34: 234-241, 1995

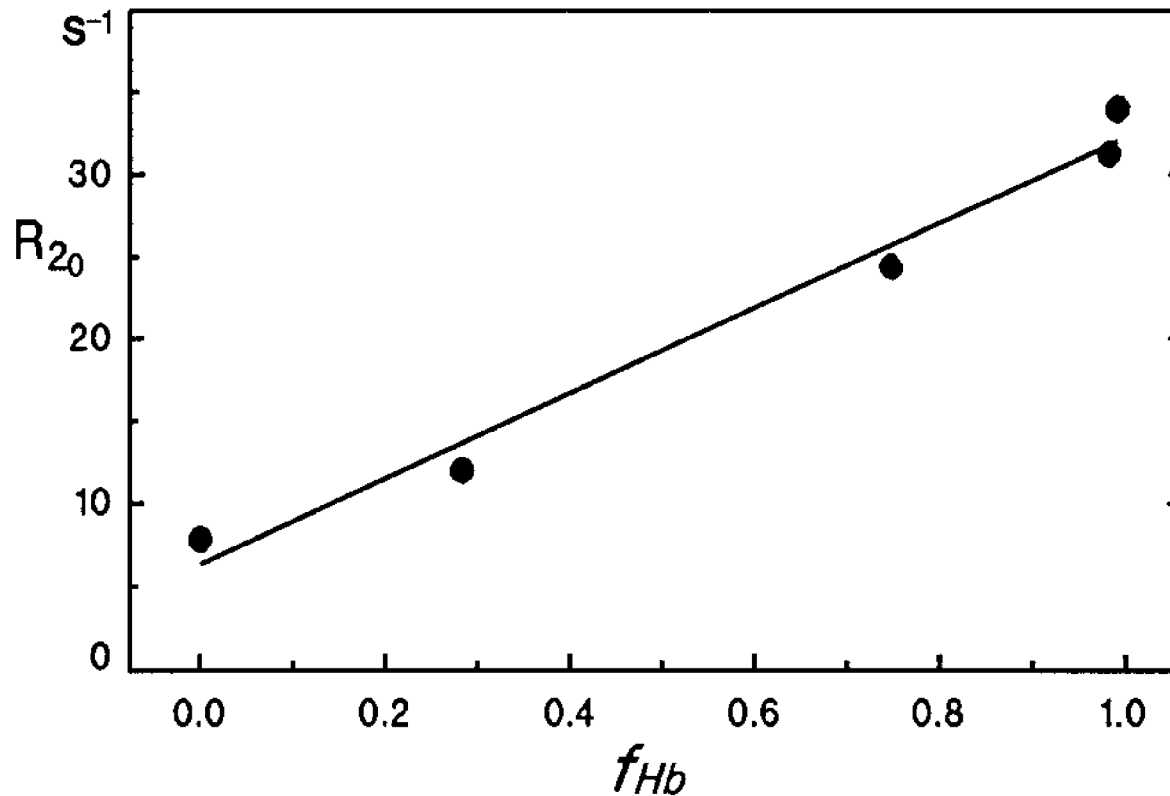
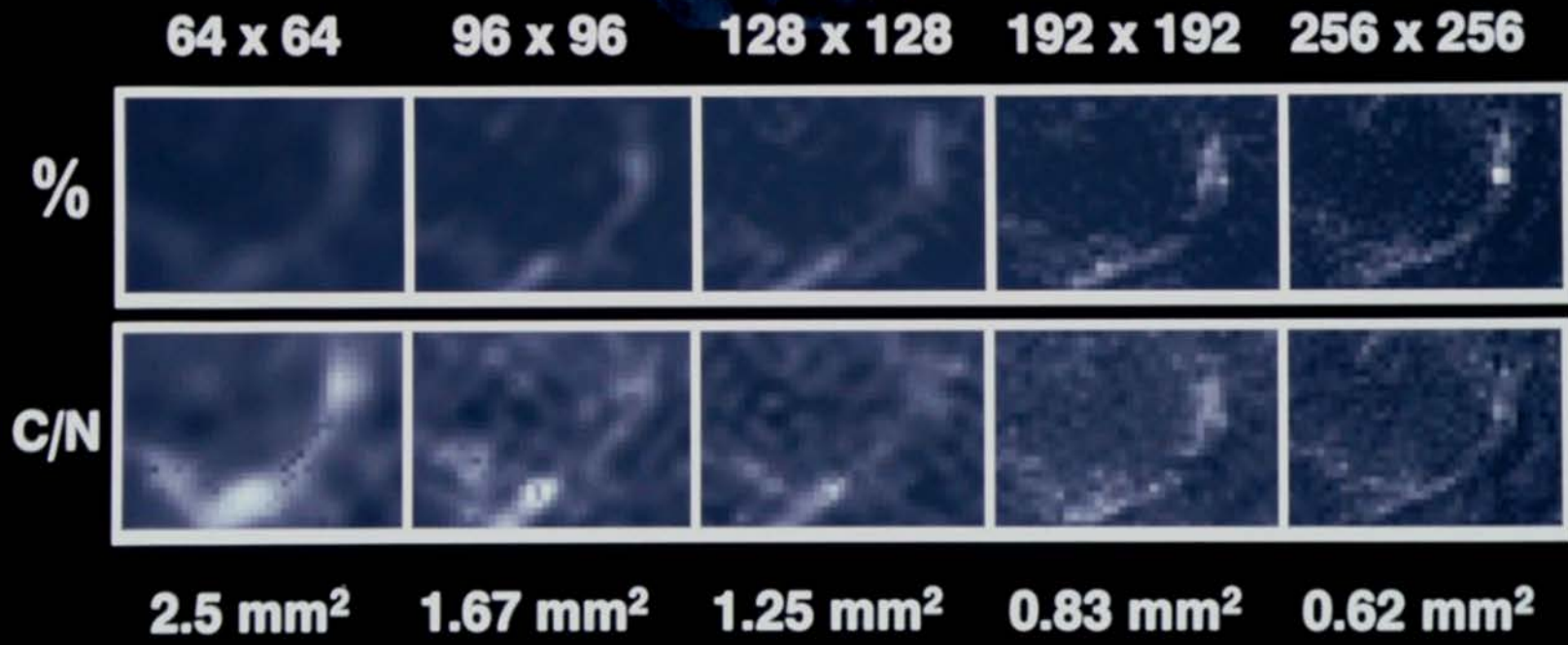

FIG. 4. Dependence of the relaxation rate in the absence of exchange ($A = R_{20}$, in Eq. [3]) on the fraction of deoxyhemoglobin in whole blood (f_{Hb}). The linear regression of this plot is $R_{20} = (26 \pm 2.13) f_{Hb} + (6.28 \pm 1.84)$; $r^2 = 0.98$.



Fractional Signal Change

2.5 mm²

1.25 mm²

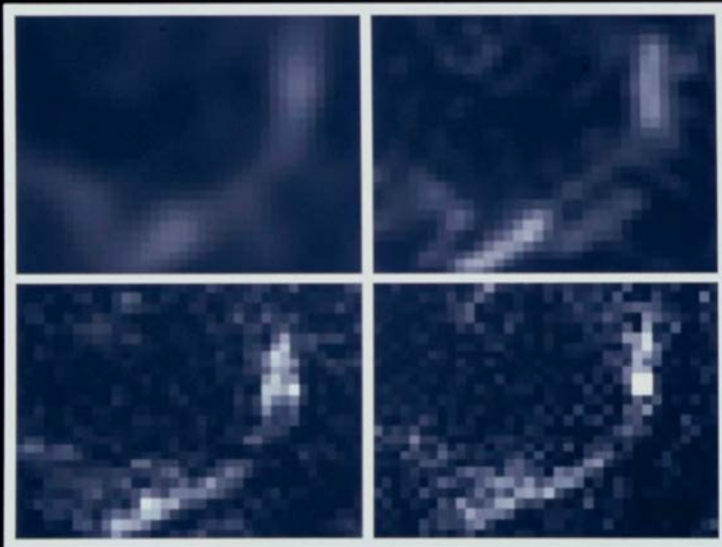

0.83 mm²

0.62 mm²

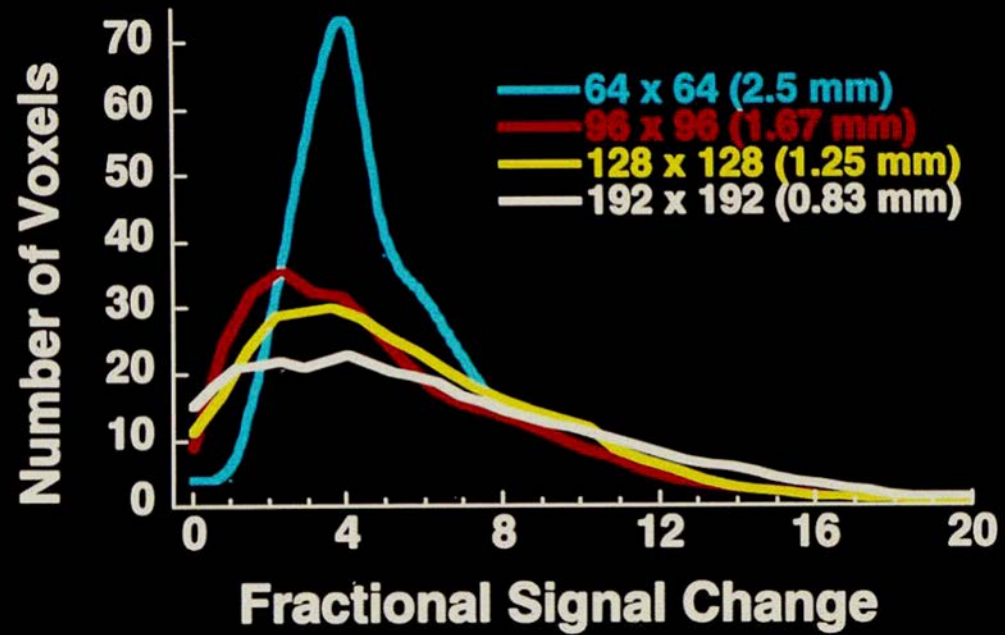

????????????????????????????????

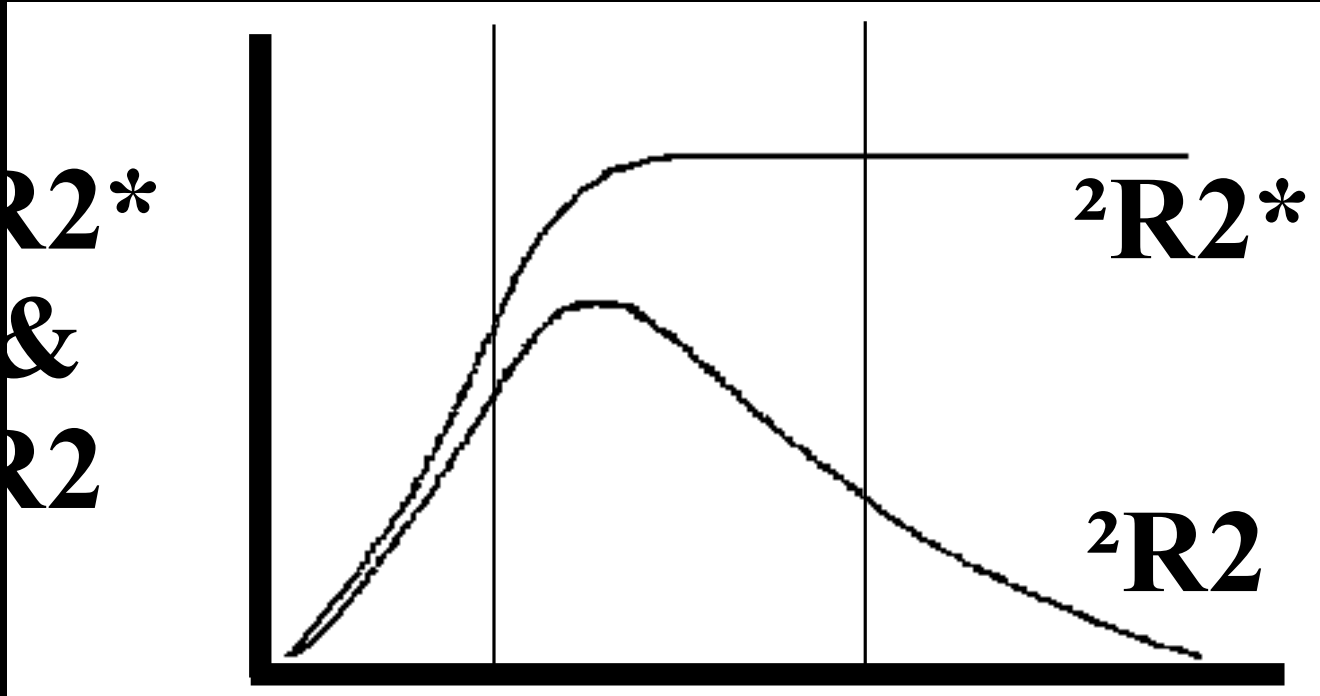

????????????????

????????????????

??????

??

$$\Delta R2^* / \Delta R2$$

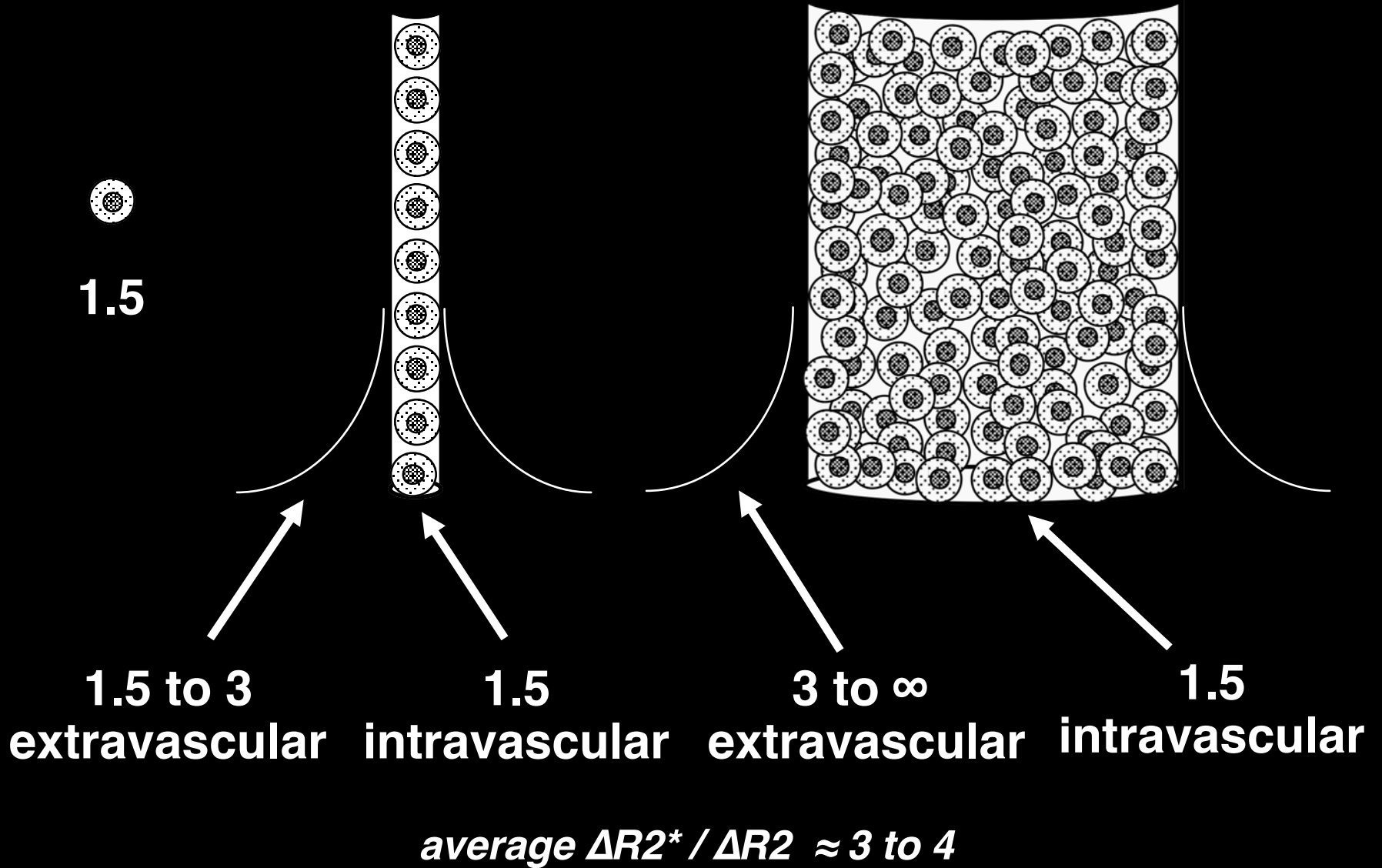

$b = 0$

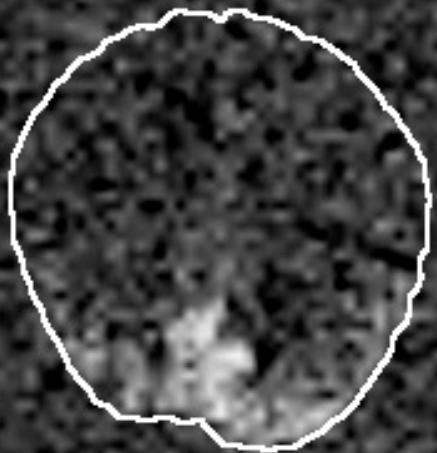

$b = 10$

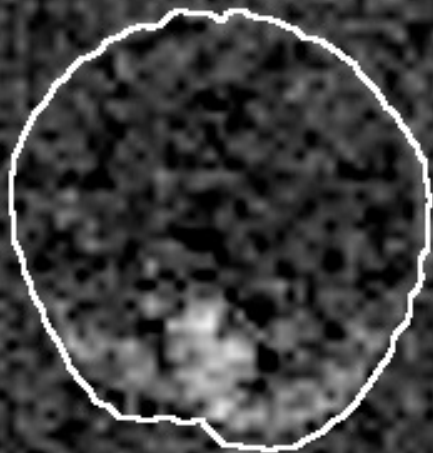

$b = 50$

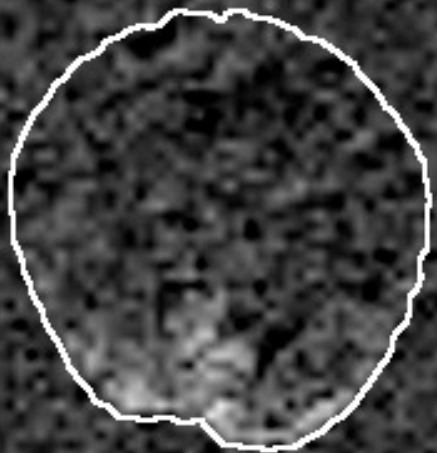

$b = 160$



Summary of Diffusion-Weighted fMRI Data

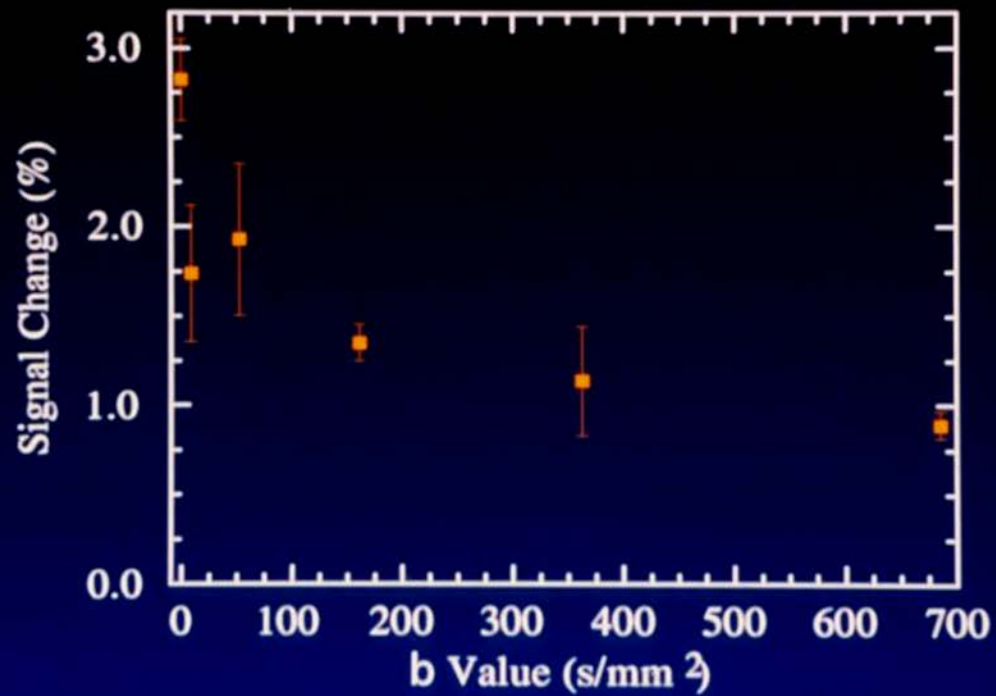

Anatomy



BOLD



Perfusion



Simultaneous Flow and BOLD

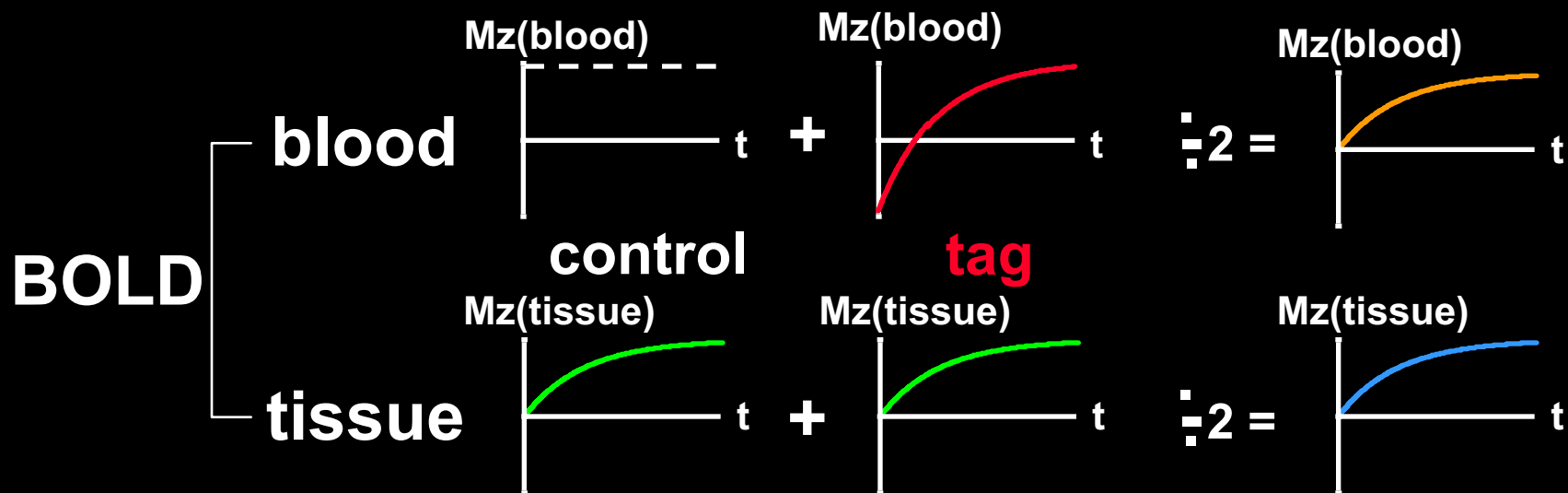
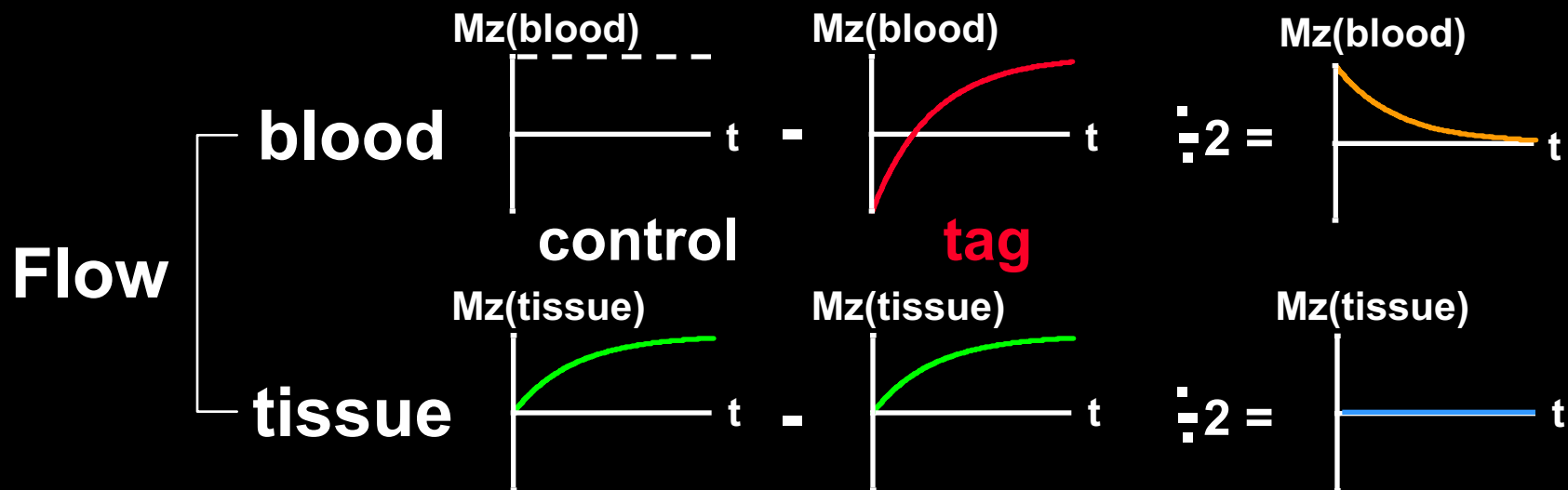

Simultaneous BOLD and Perfusion

perfusion

BOLD

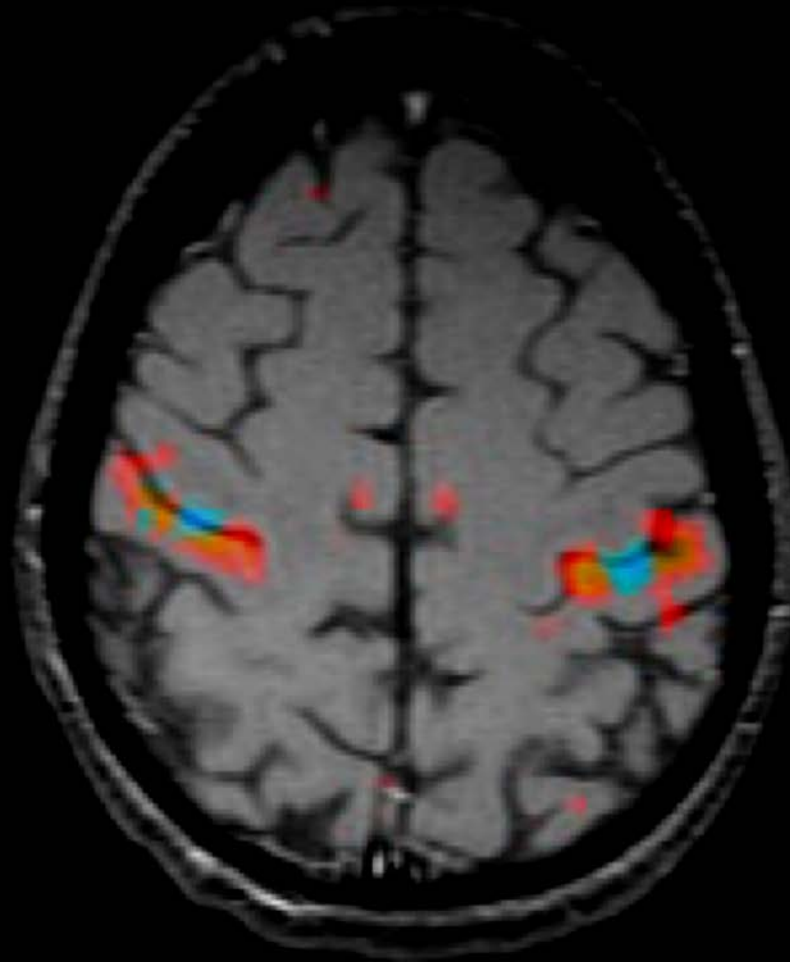

Angiogram
Perfusion
BOLD

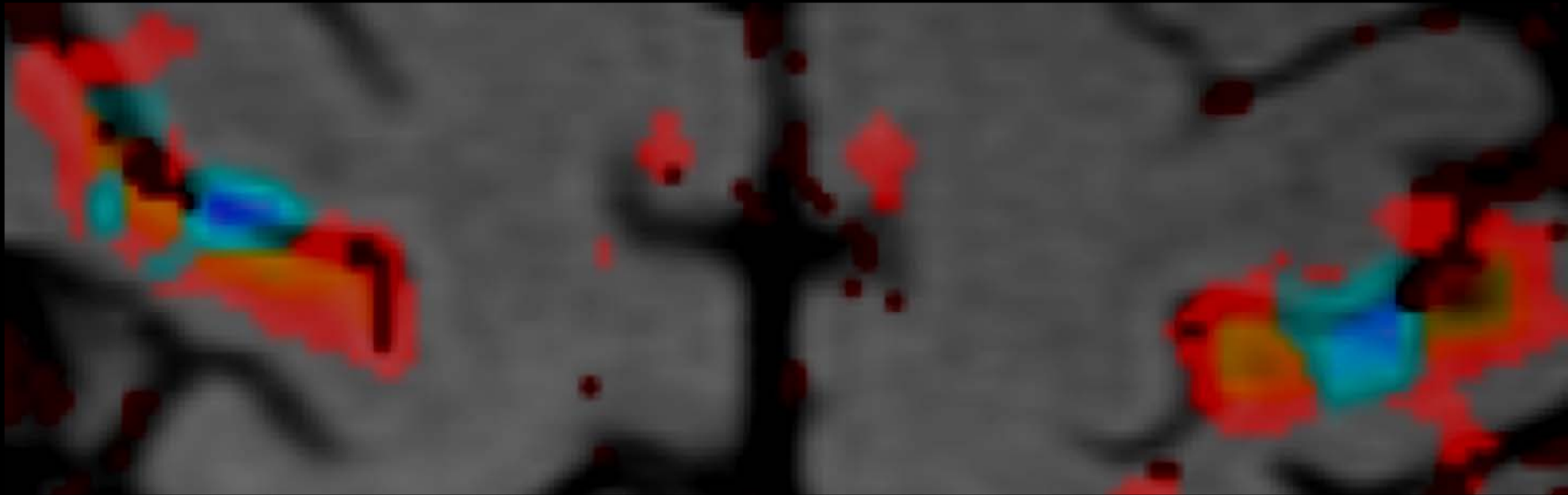

T1 - weighted

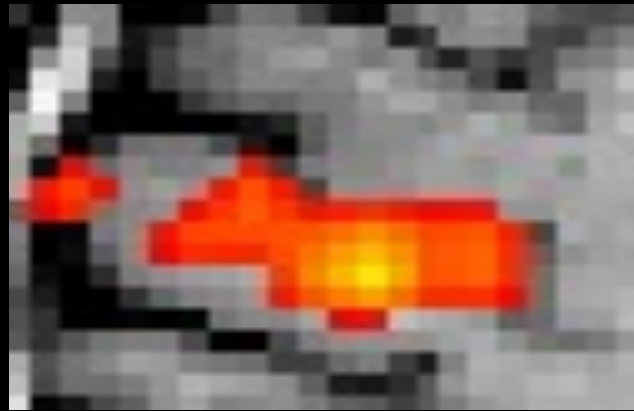

T2* weighted



**T1 and T2*
weighted**



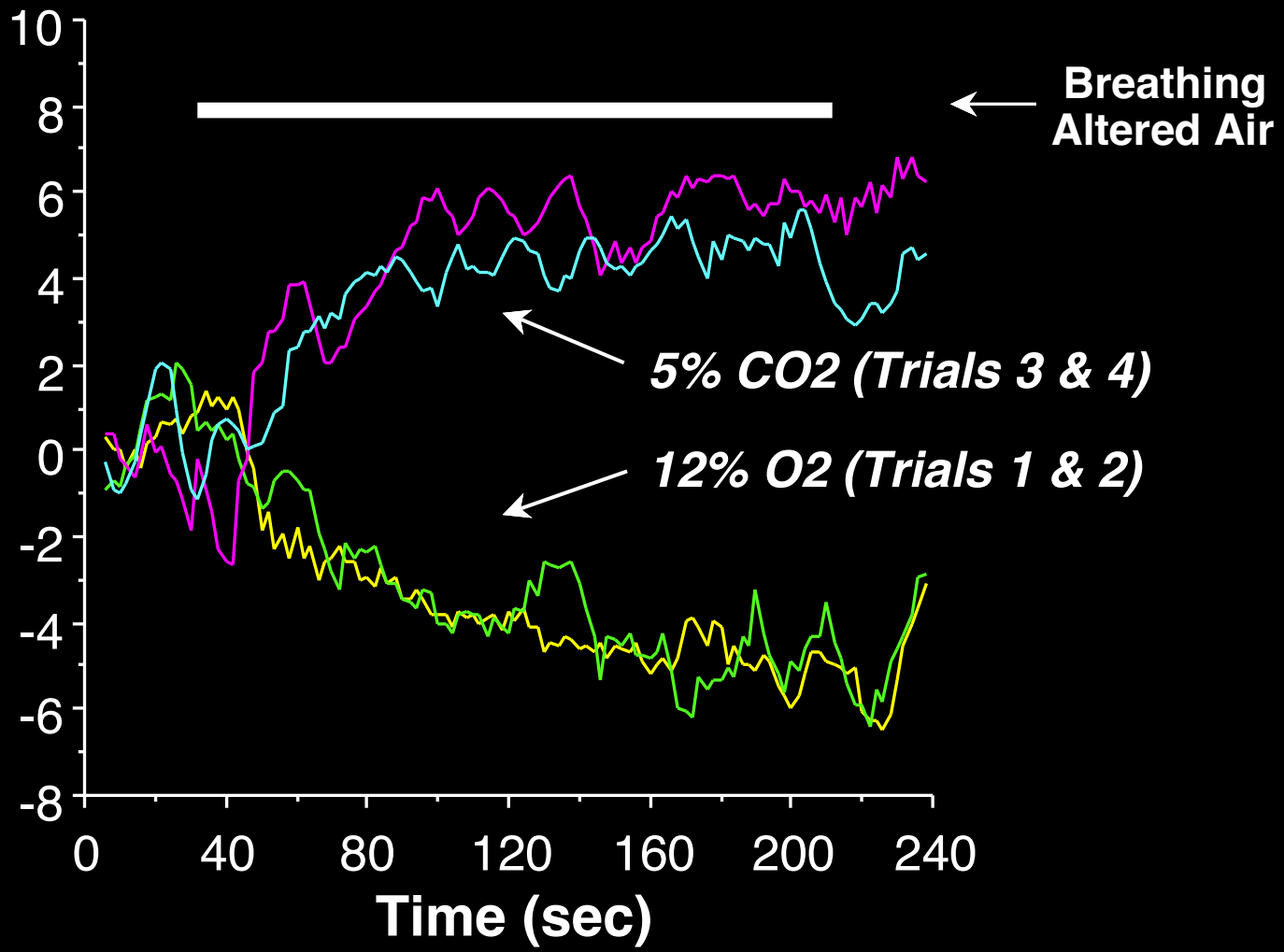

,

Anatomical

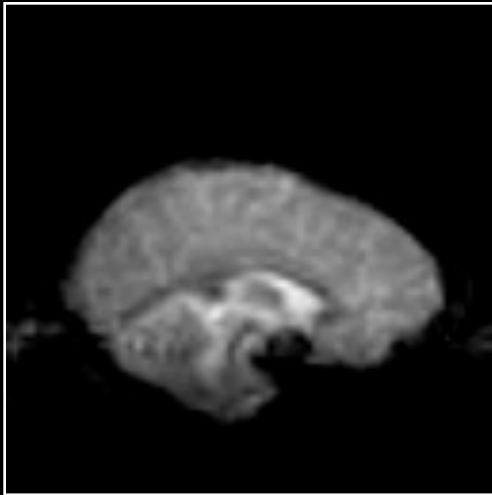

**Finger
Movement**



12% O2

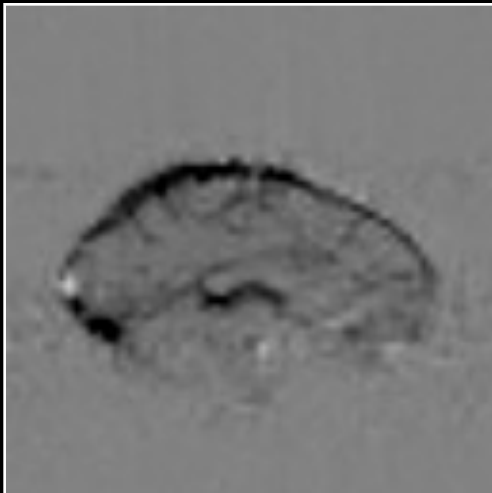

5% CO2

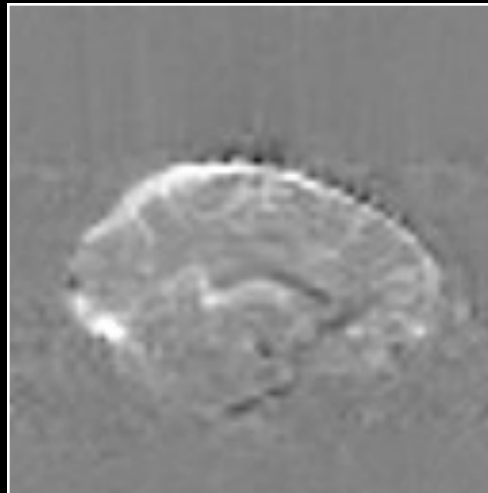

Resting State Blood Volume Weighting

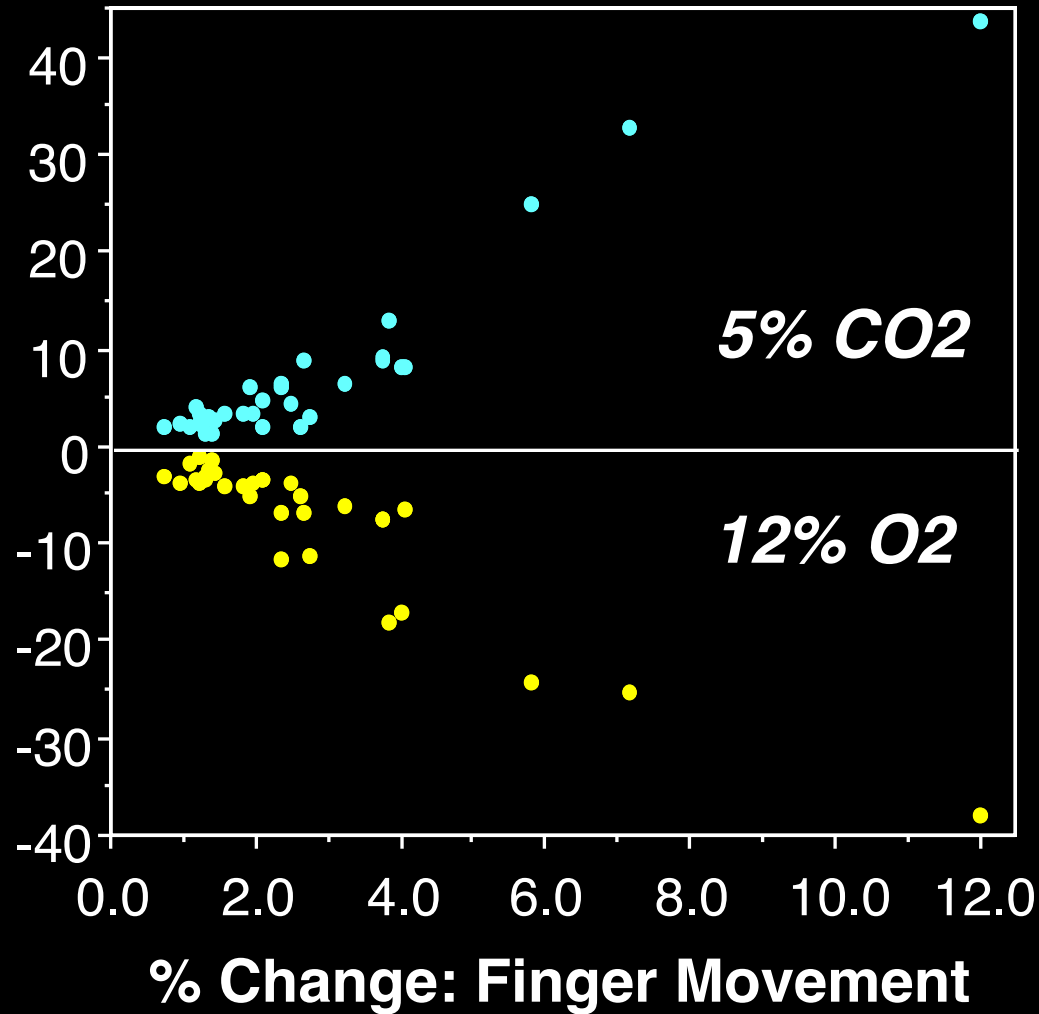

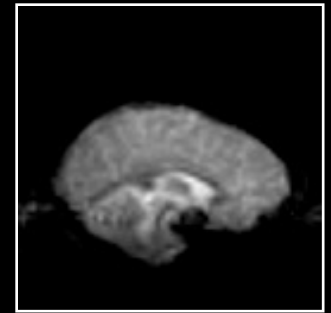

· · · · · Capillaries
——— Veins



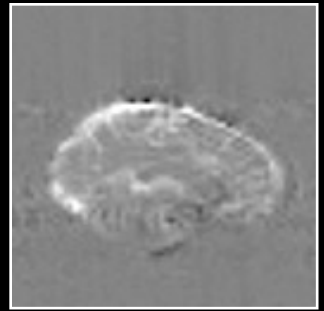



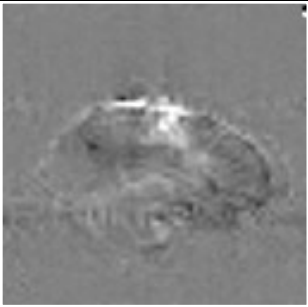

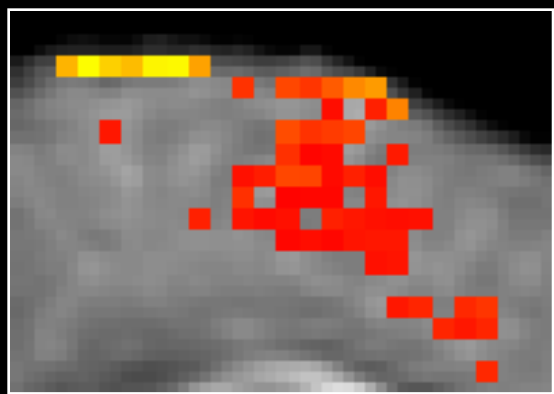

?

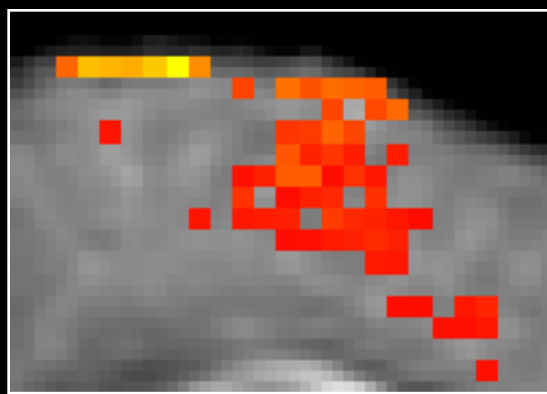

?

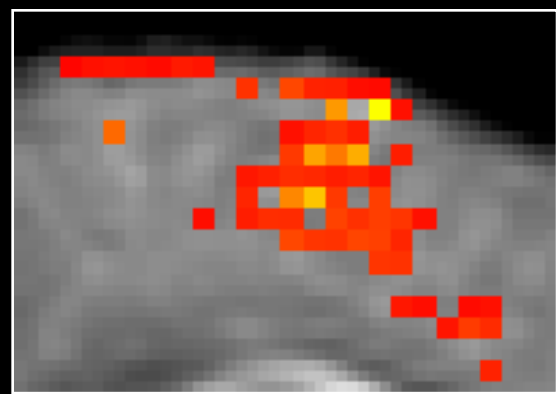

Latency

Magnitude

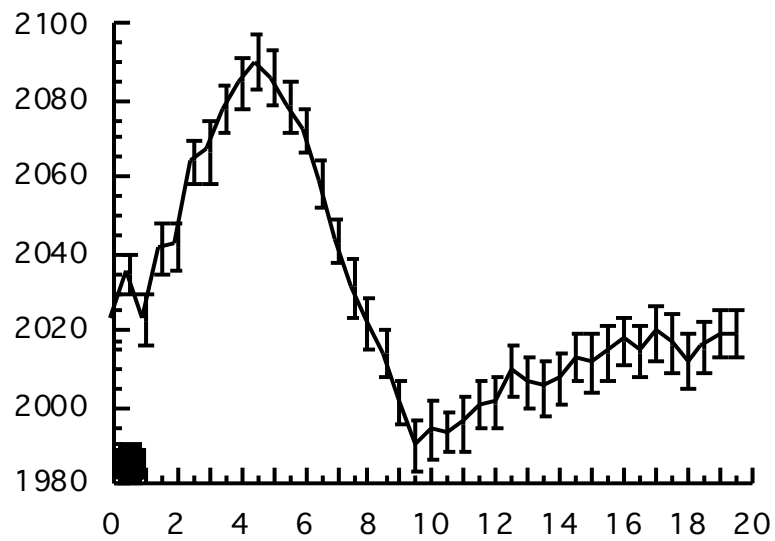
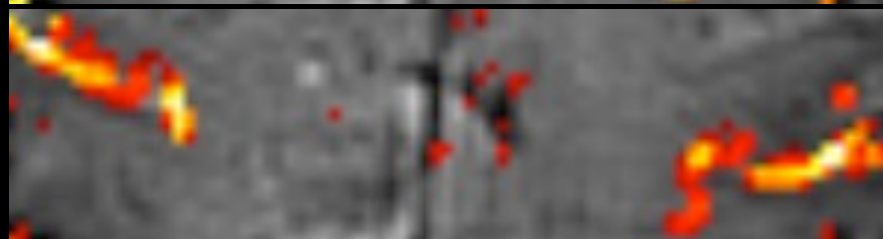
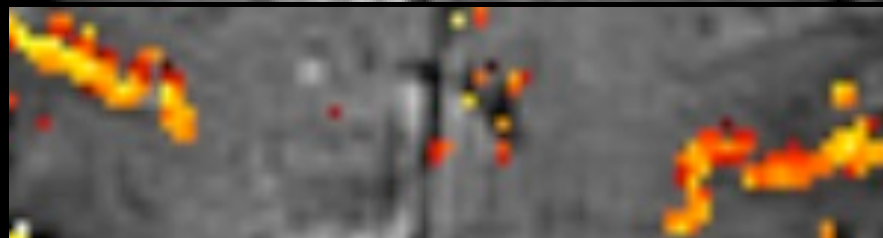

Time (sec)

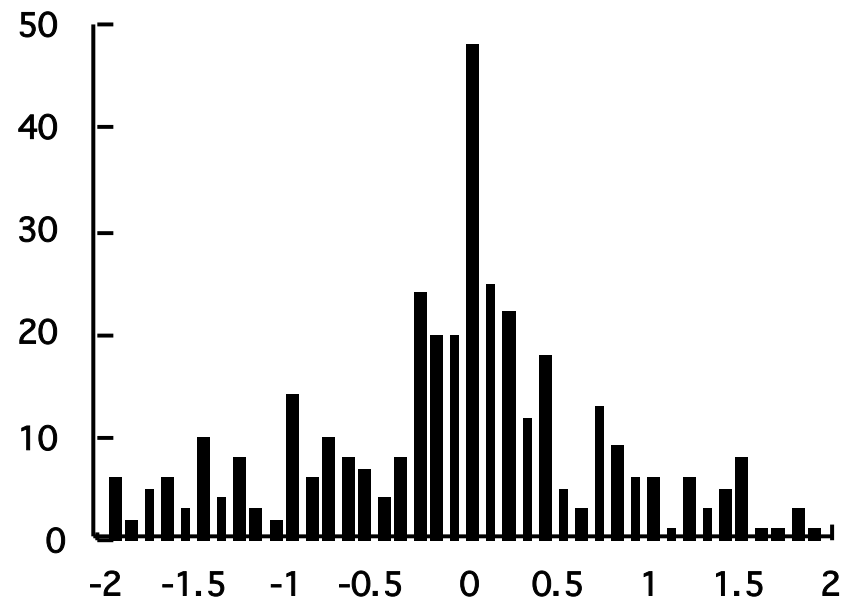

Delay (sec)

1991-1992



1992-1999



GE
TE = 30 ms

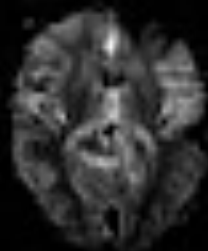

SE
TE = 110 ms



BOLD

BALD

GE
TE=30 ms

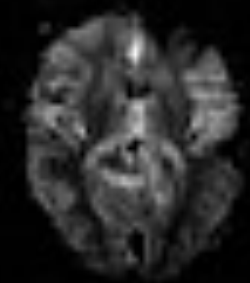

SE
TE=110 ms



GE
TE = 30 ms



SE
TE = 110 ms

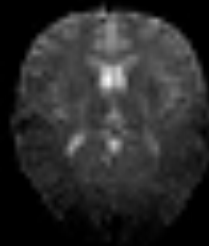

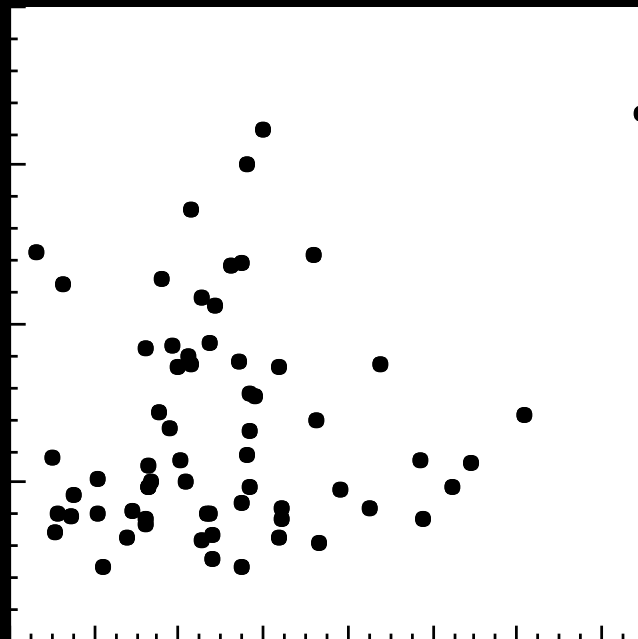
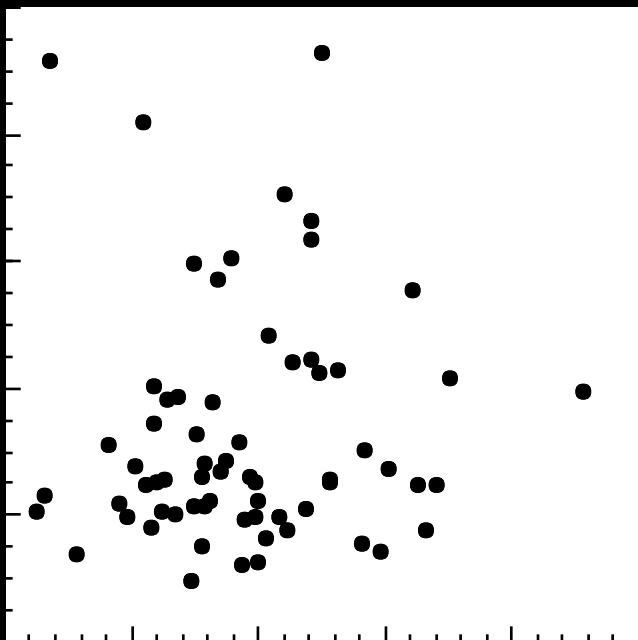

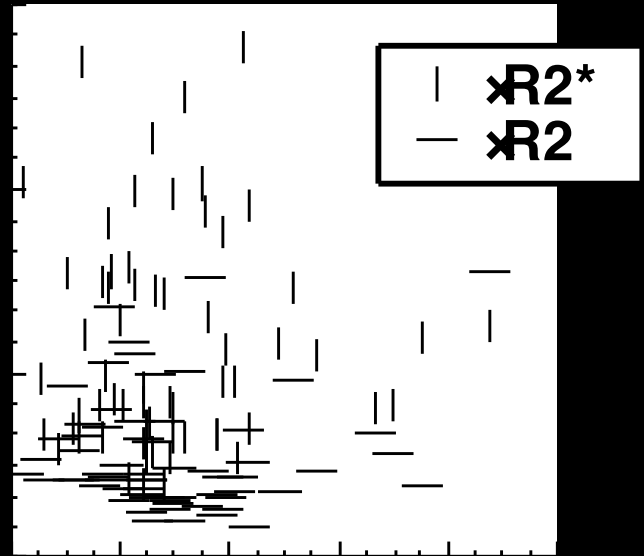
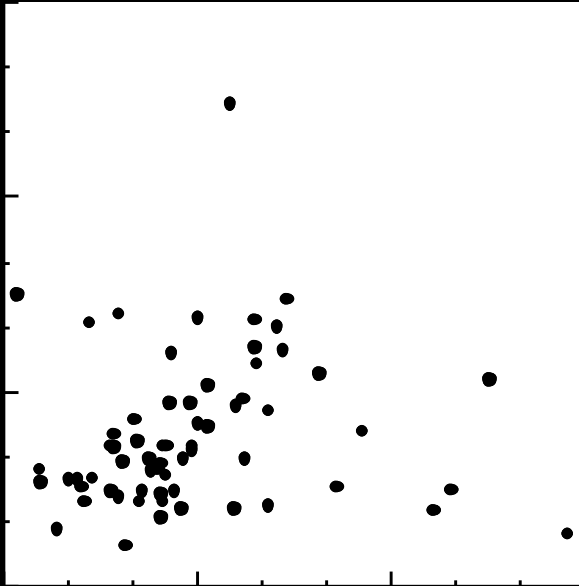

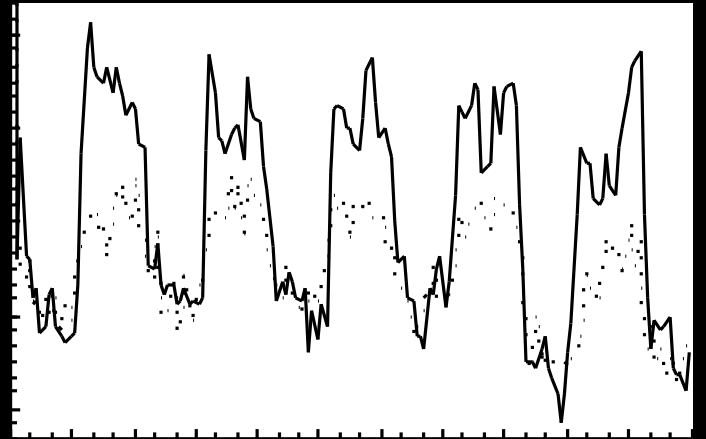
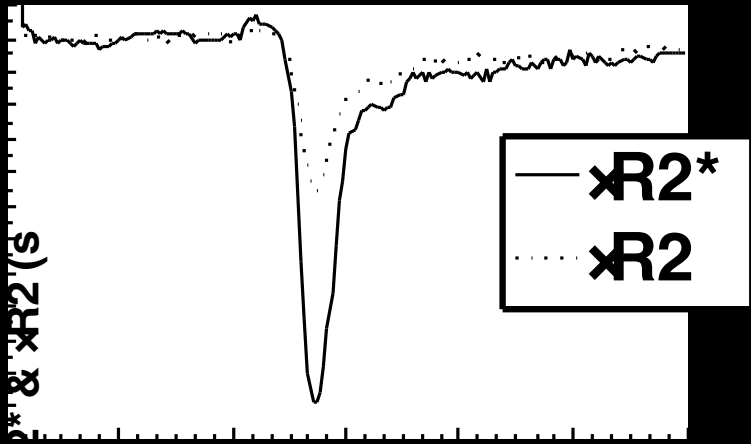

GE
(TE = 30 ms)

SE
(TE = 110 ms)

Subject 1

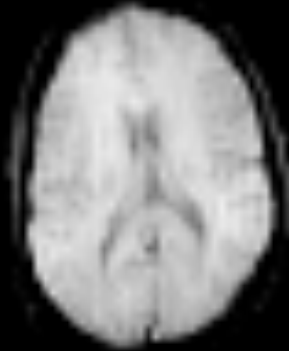

Subject 2

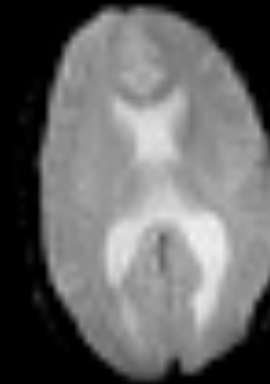

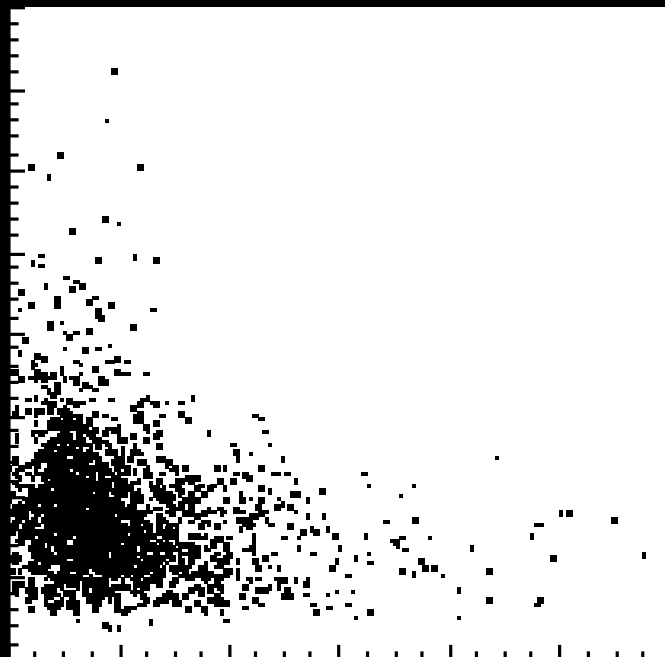
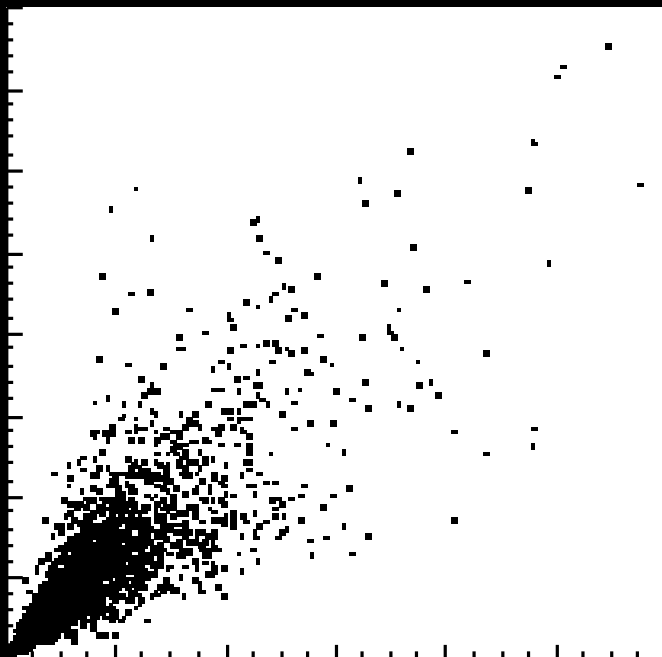

S2

Gradient - Echo

Spin - Echo

**During
Activation
Increase**



**Post
Activation
Undershoot**



Gradient - Echo

Spin - Echo

**During
Activation
Increase**

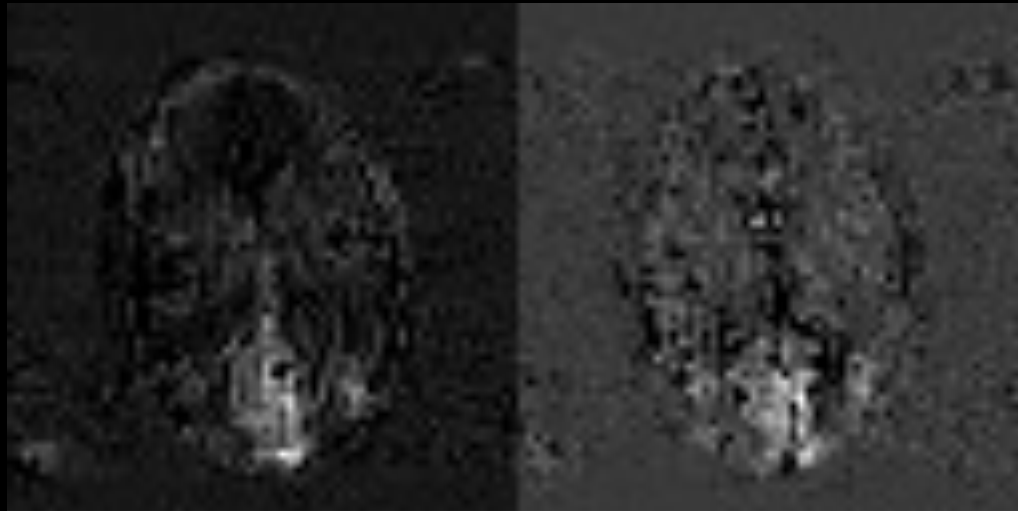

**Post
Activation
Undershoot**

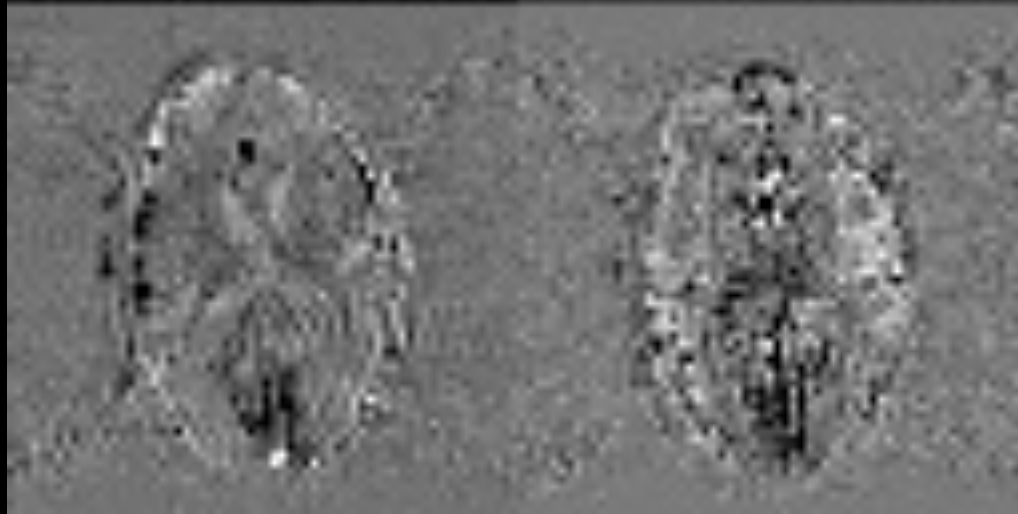

??

????????

Visual task

Motor task

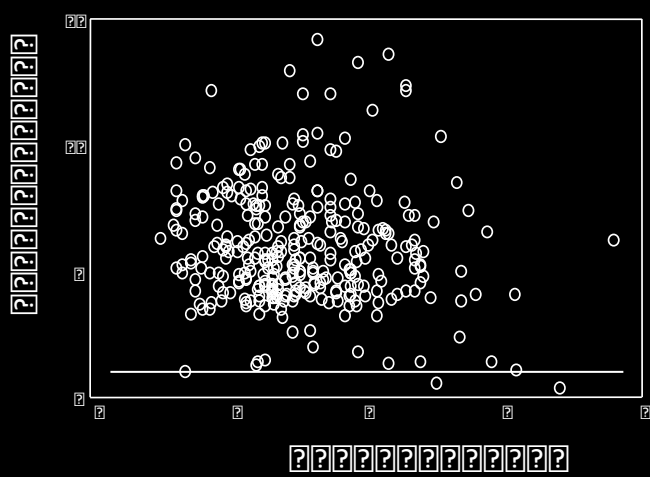
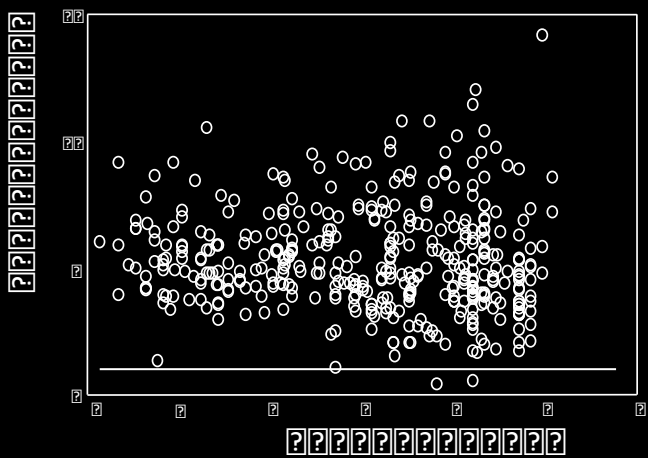
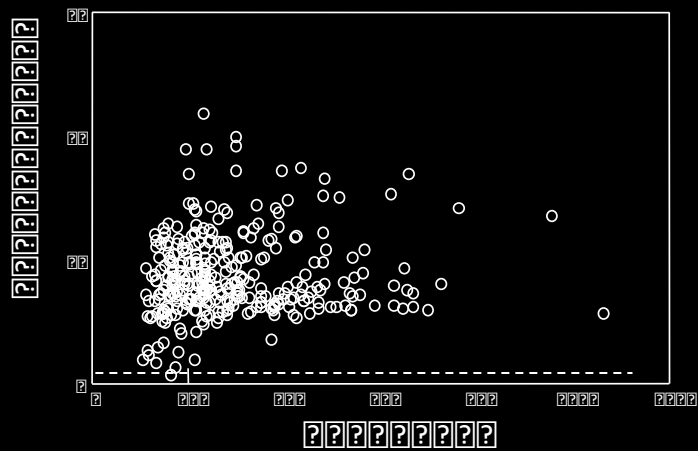
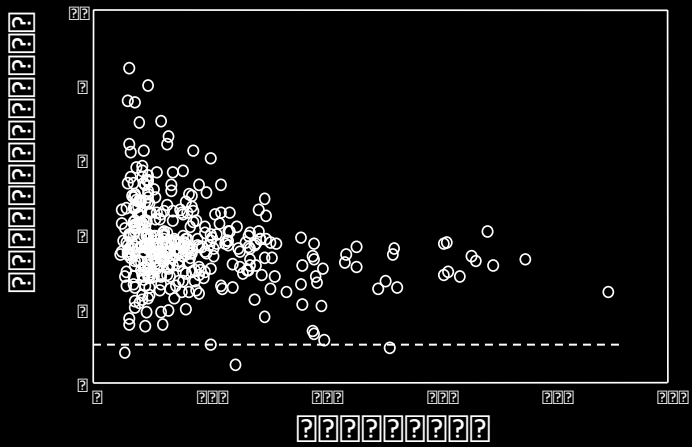

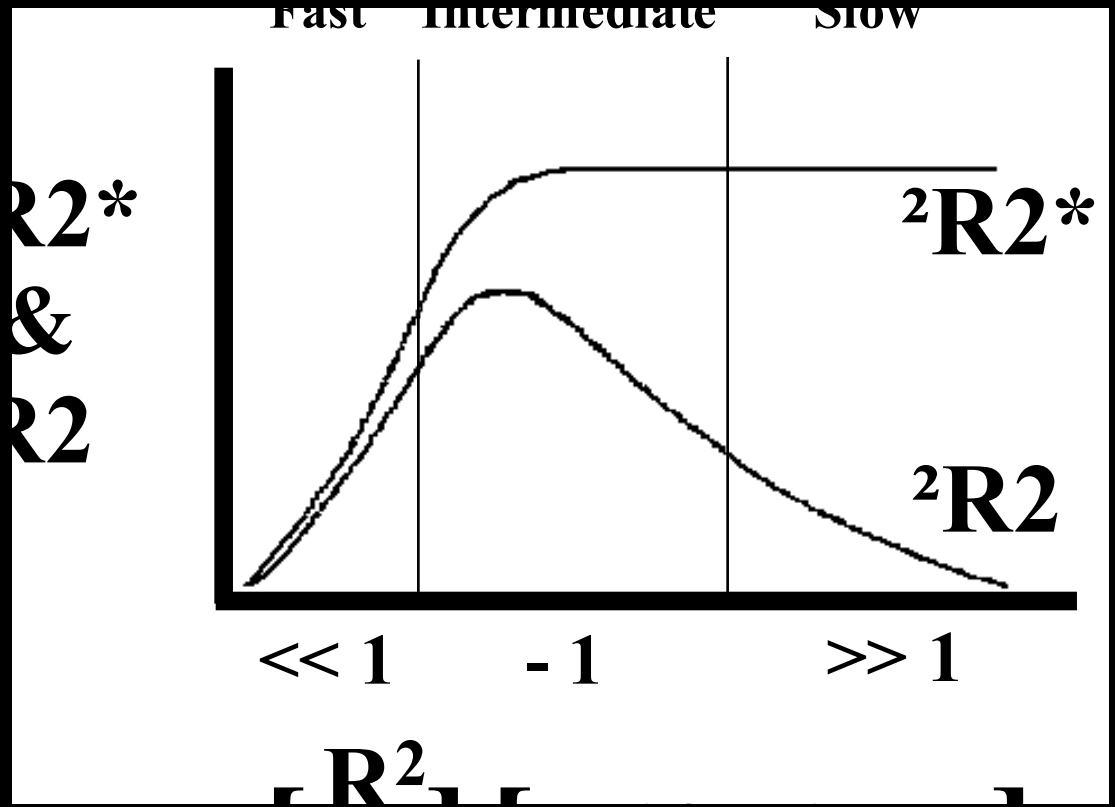

no diffusion weighting

diffusion weighting

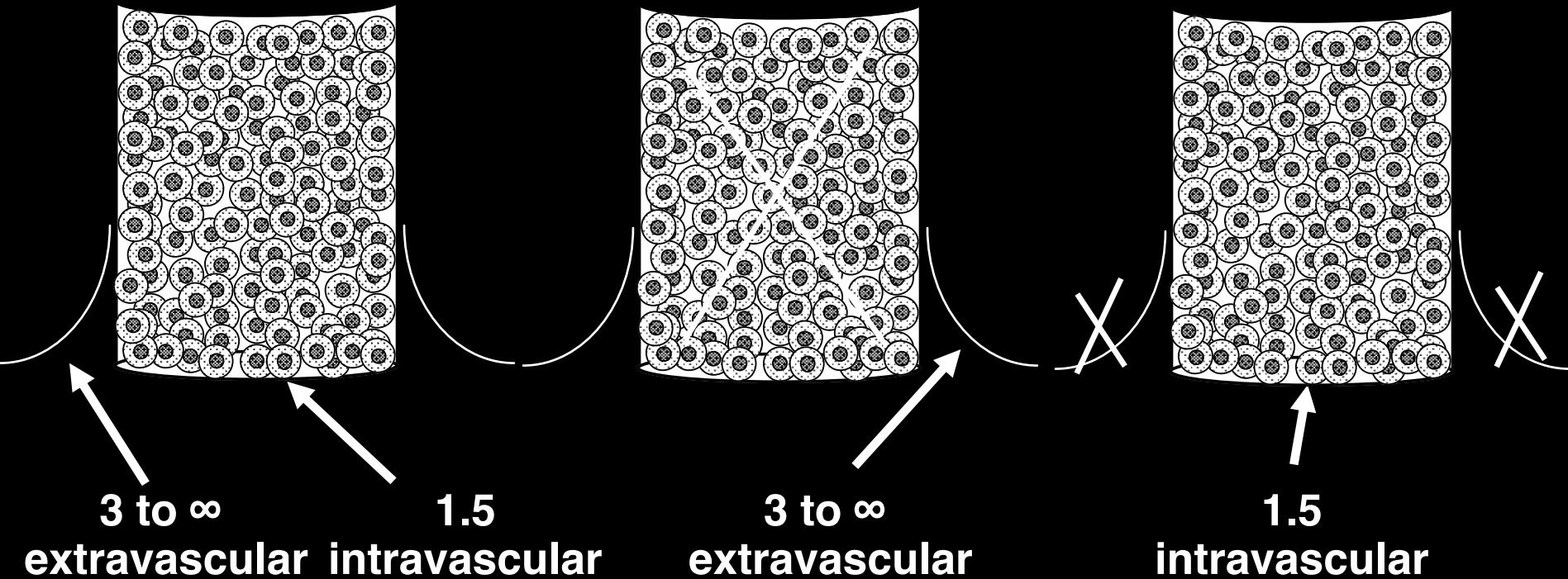

$\Delta R2^* / \Delta R2:$	$\Delta R2^* / \Delta R2$ increase	$\Delta R2^* / \Delta R2$ decrease
= IV and EV	= EV only	= IV only

BOLD

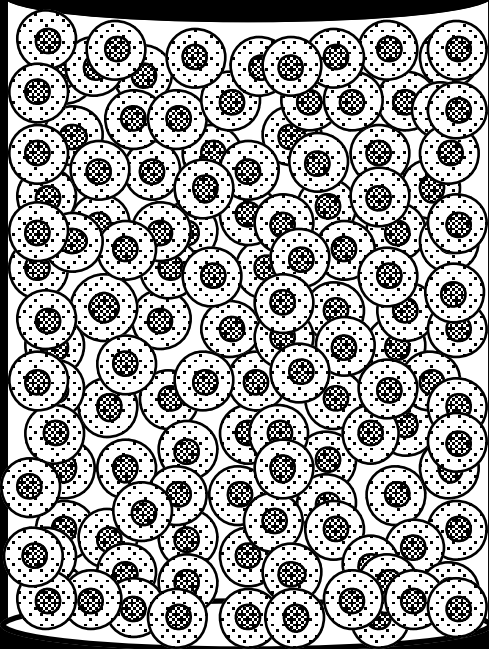

plasma $\chi < \text{rbc } \chi$

BALD

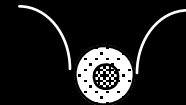
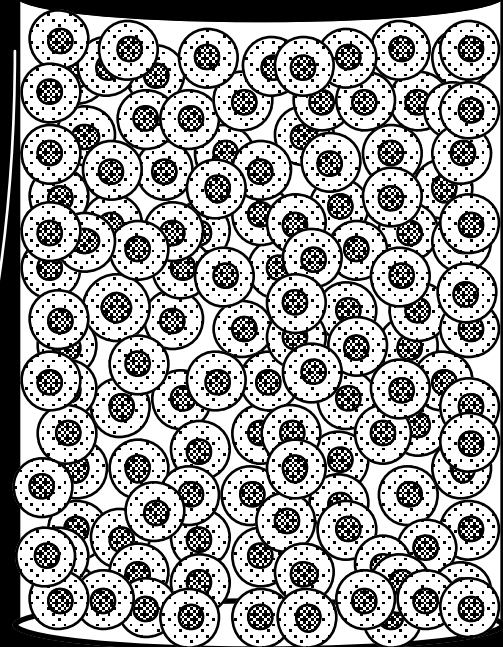

plasma $\chi > \text{rbc } \chi$

GE
visual

SE
visual

GE
motor

SE
motor

subject 1

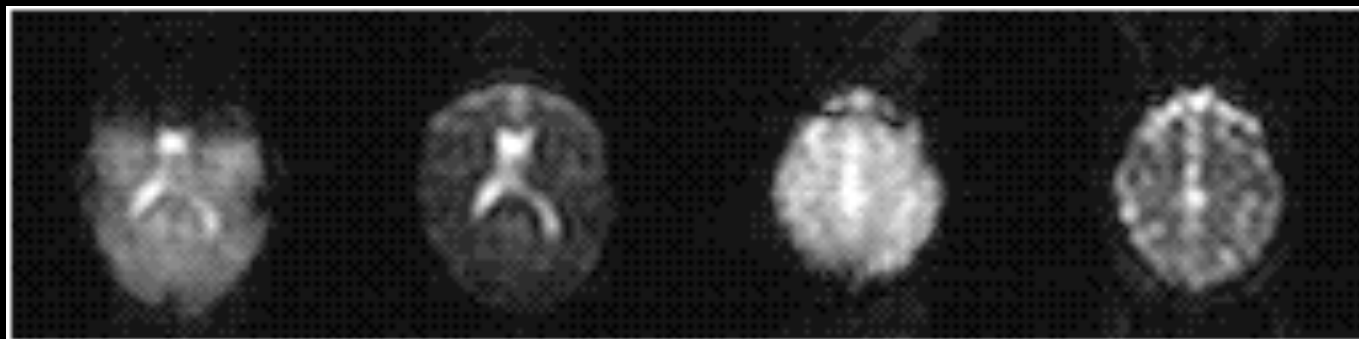

b = 0

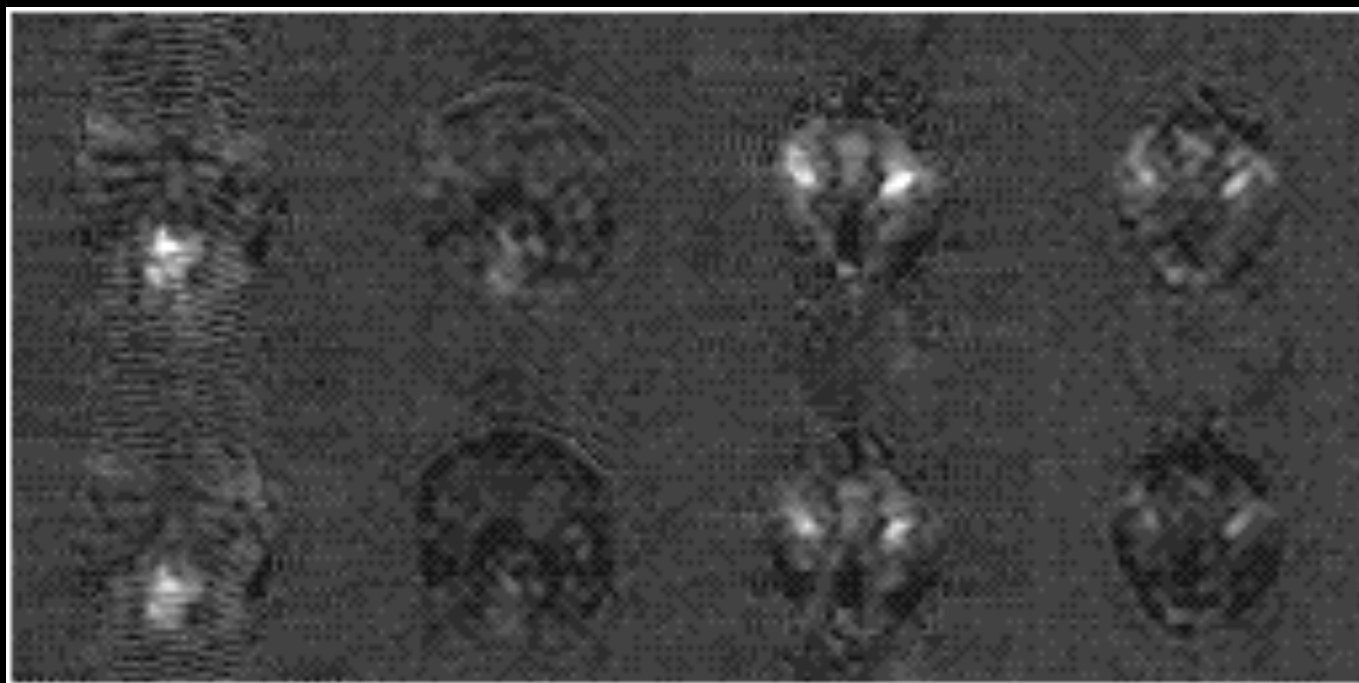

b = 22

**GE
visual**

**SE
visual**

**GE
motor**

**SE
motor**

subject 2

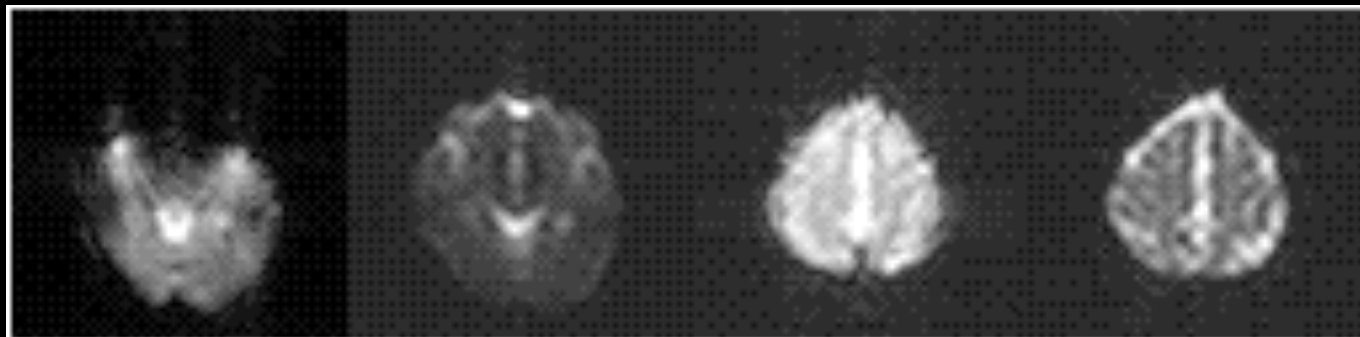

b = 0

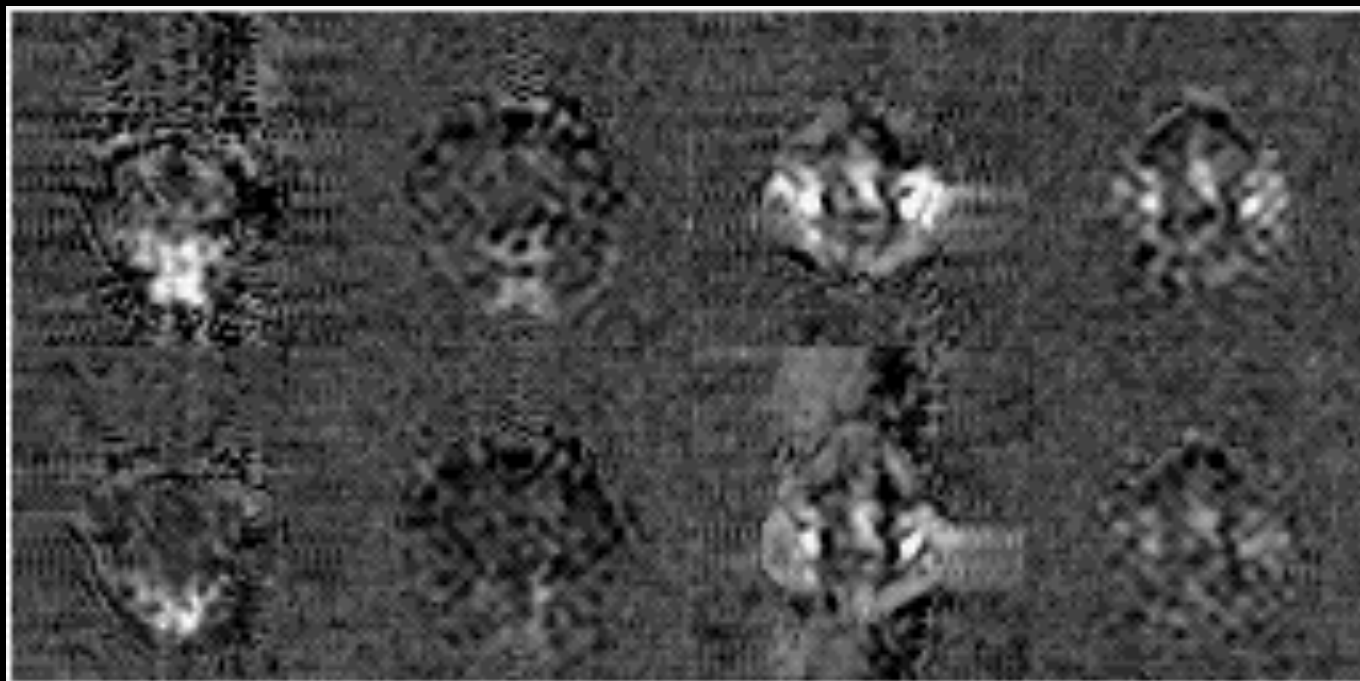

b = 22

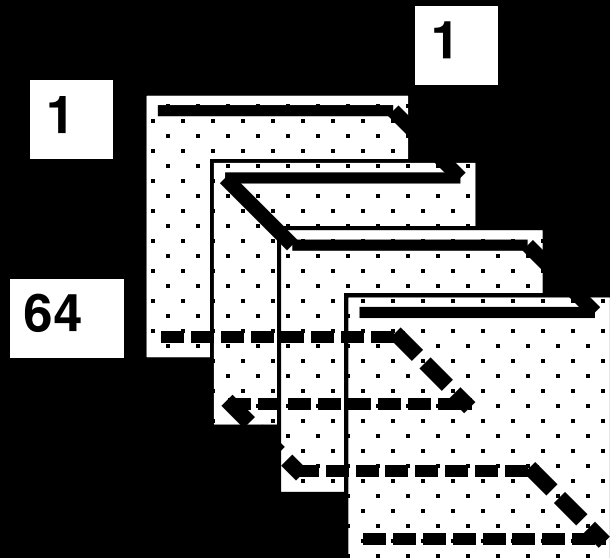

TE = 5.0

64

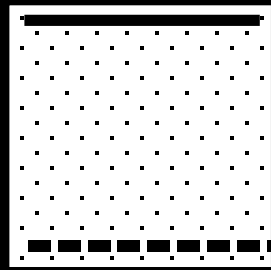

TE = 44.3

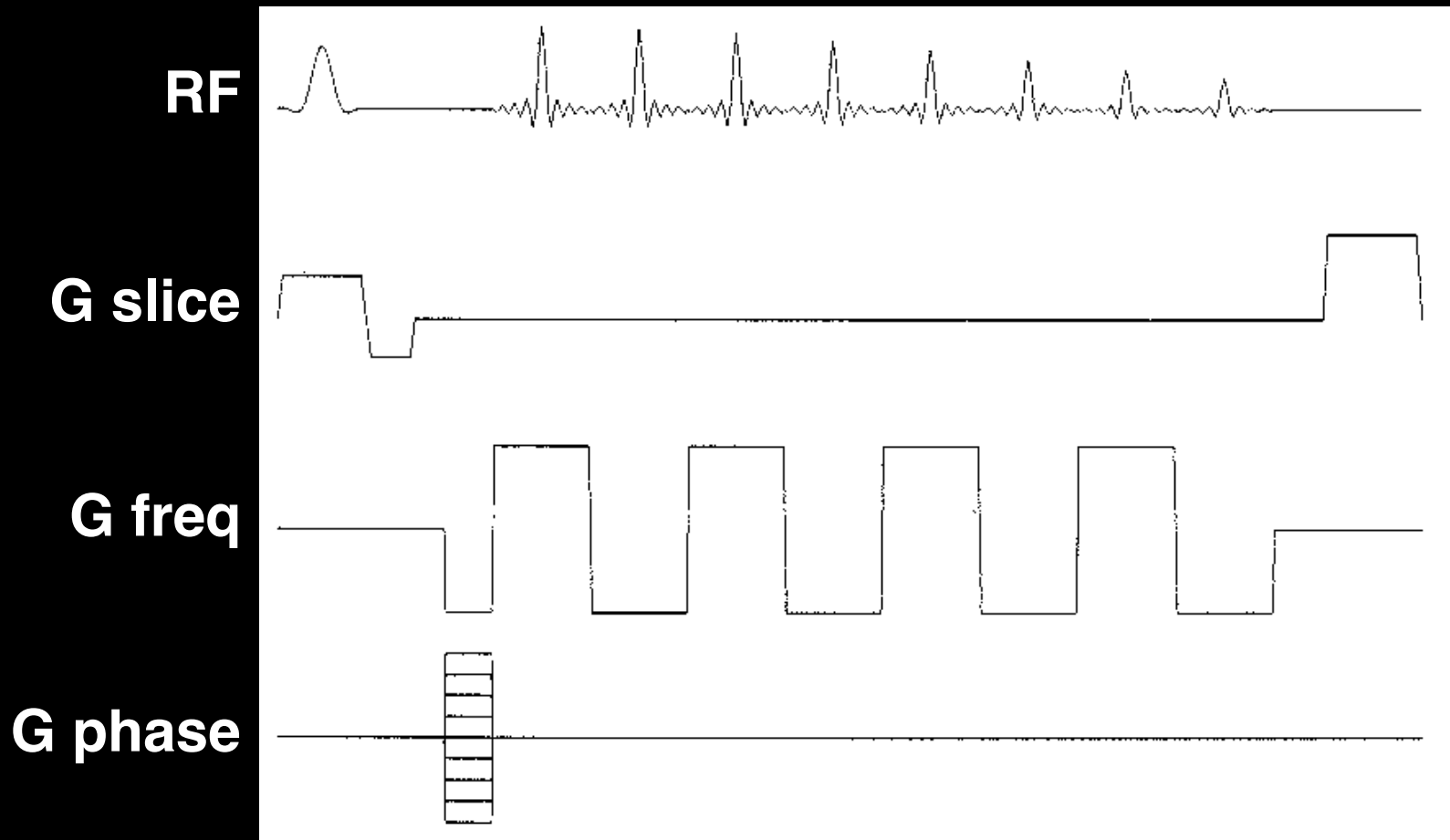

BOLD

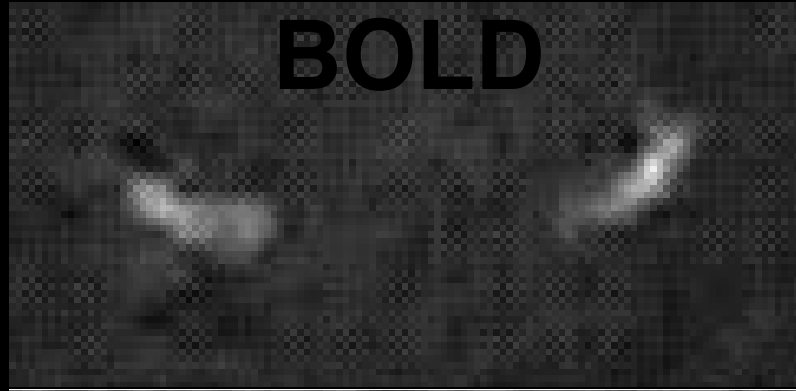

Flow

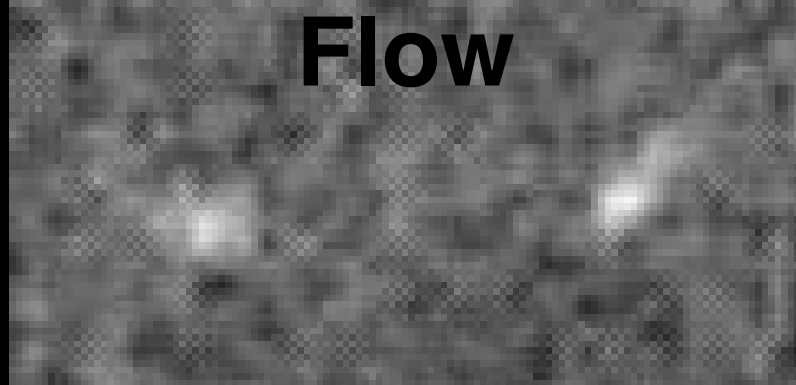

M_0

$T2^*$

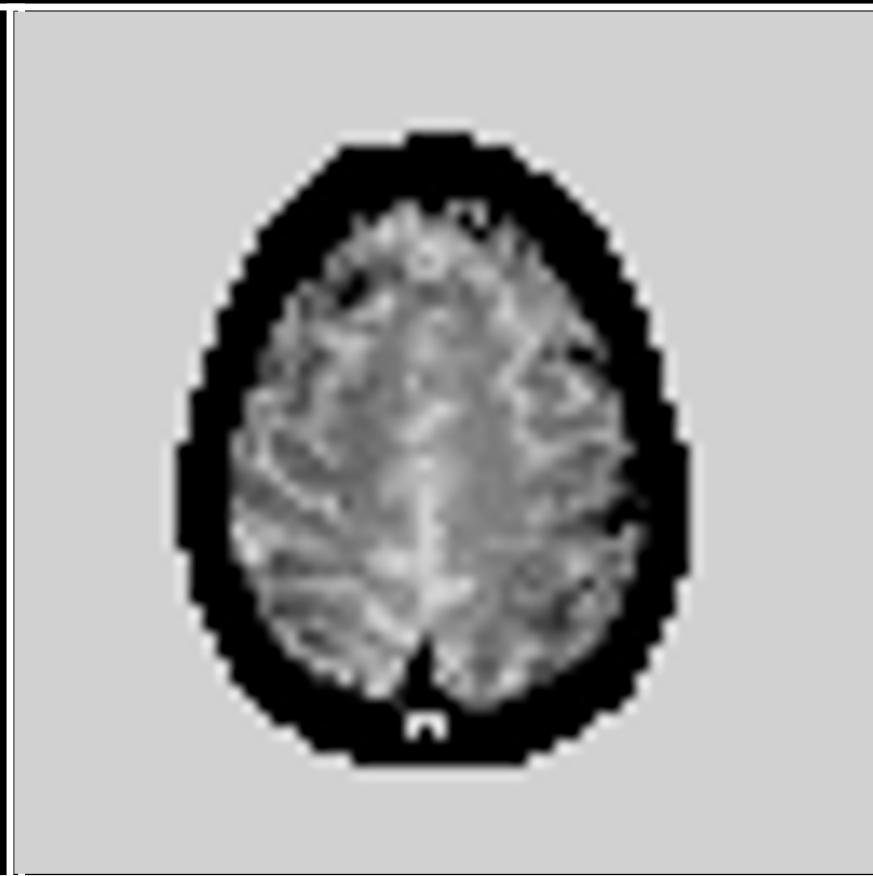
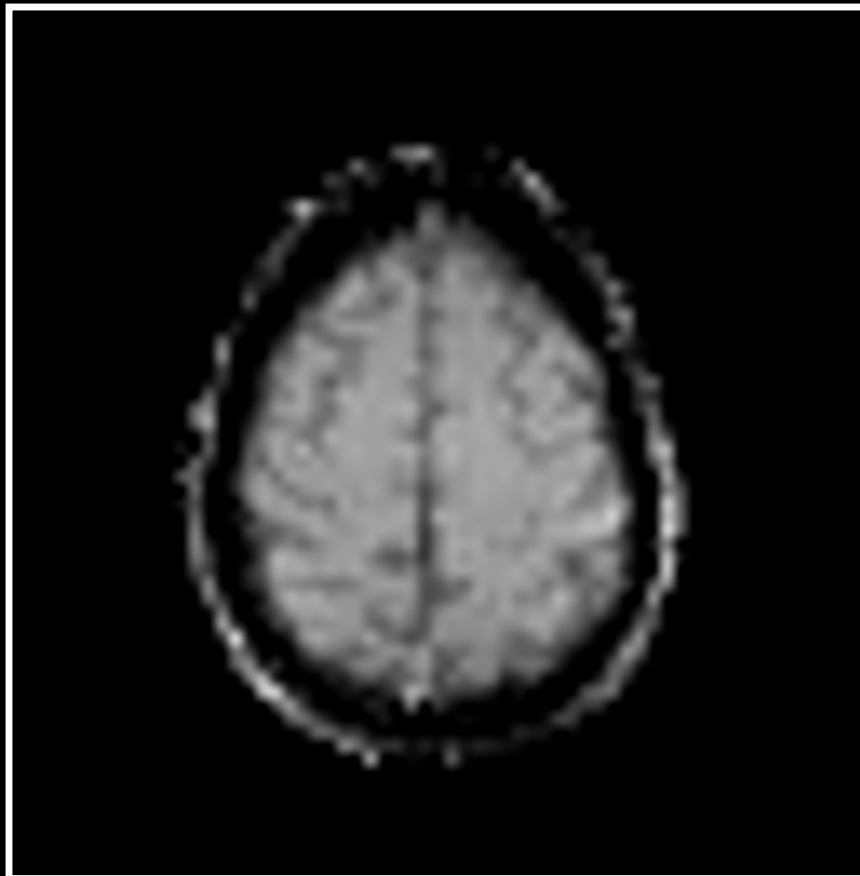

Percent Change

Difference

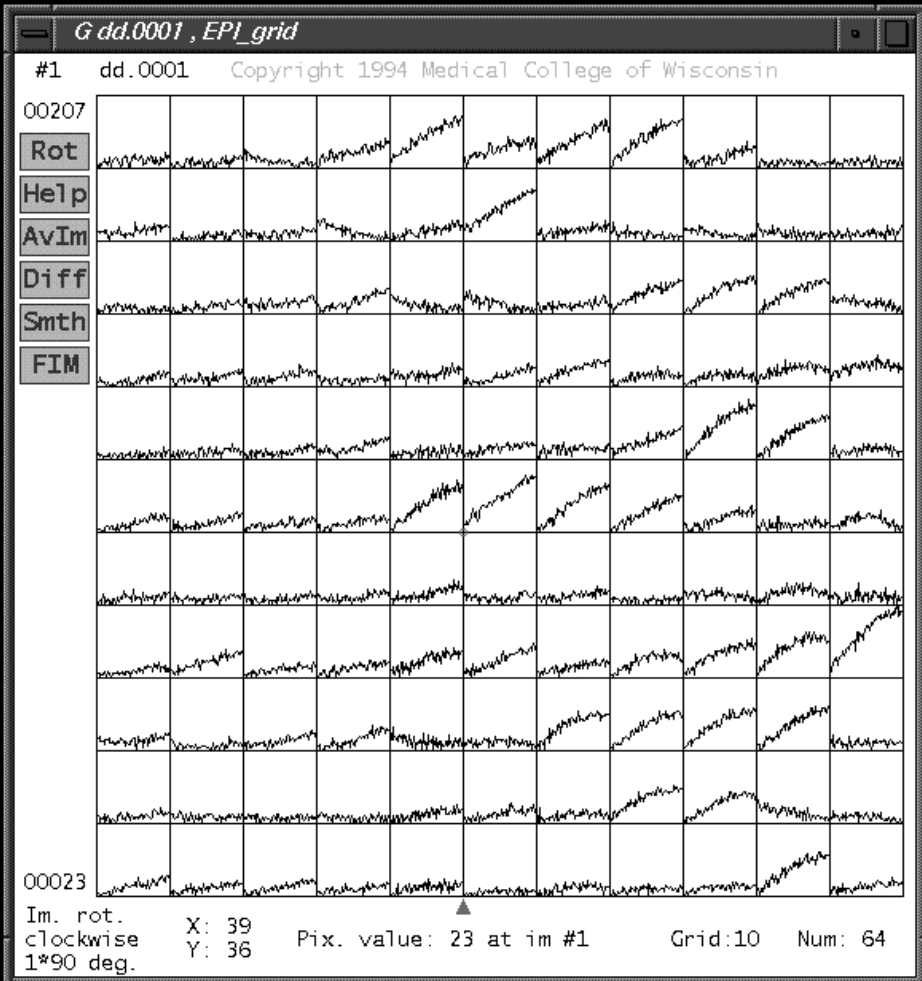
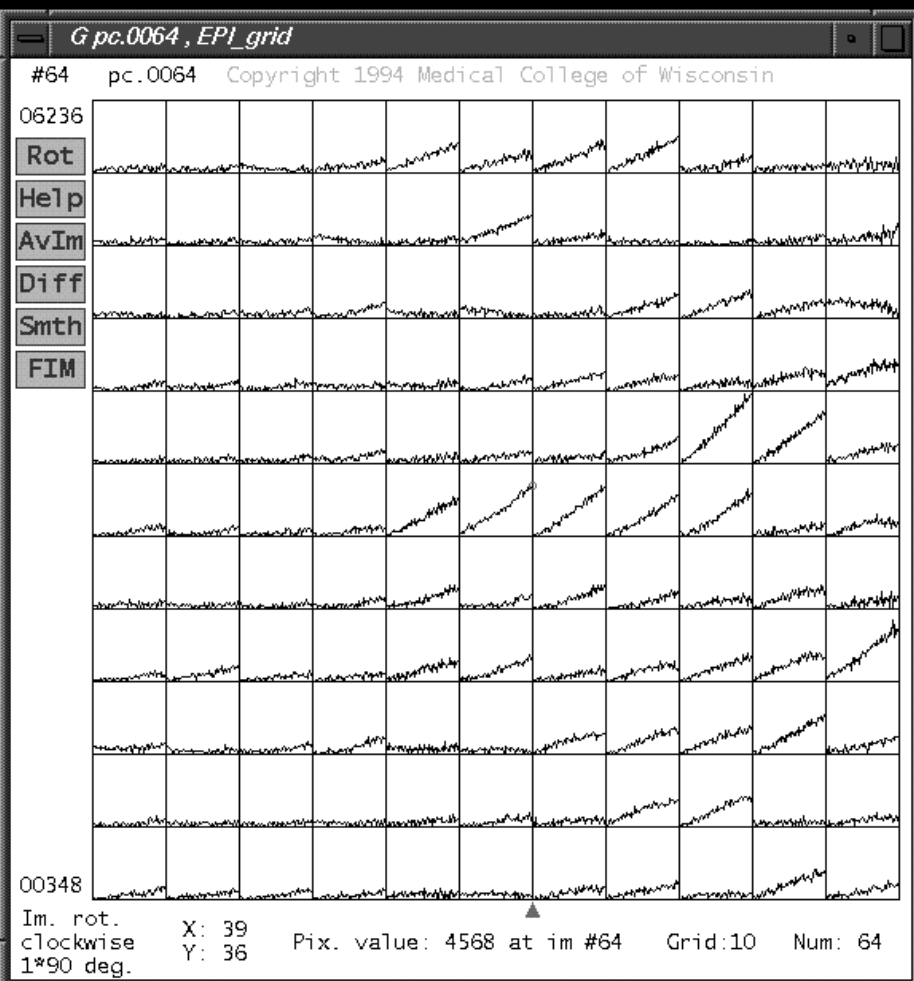

TE (5 to 44 ms)

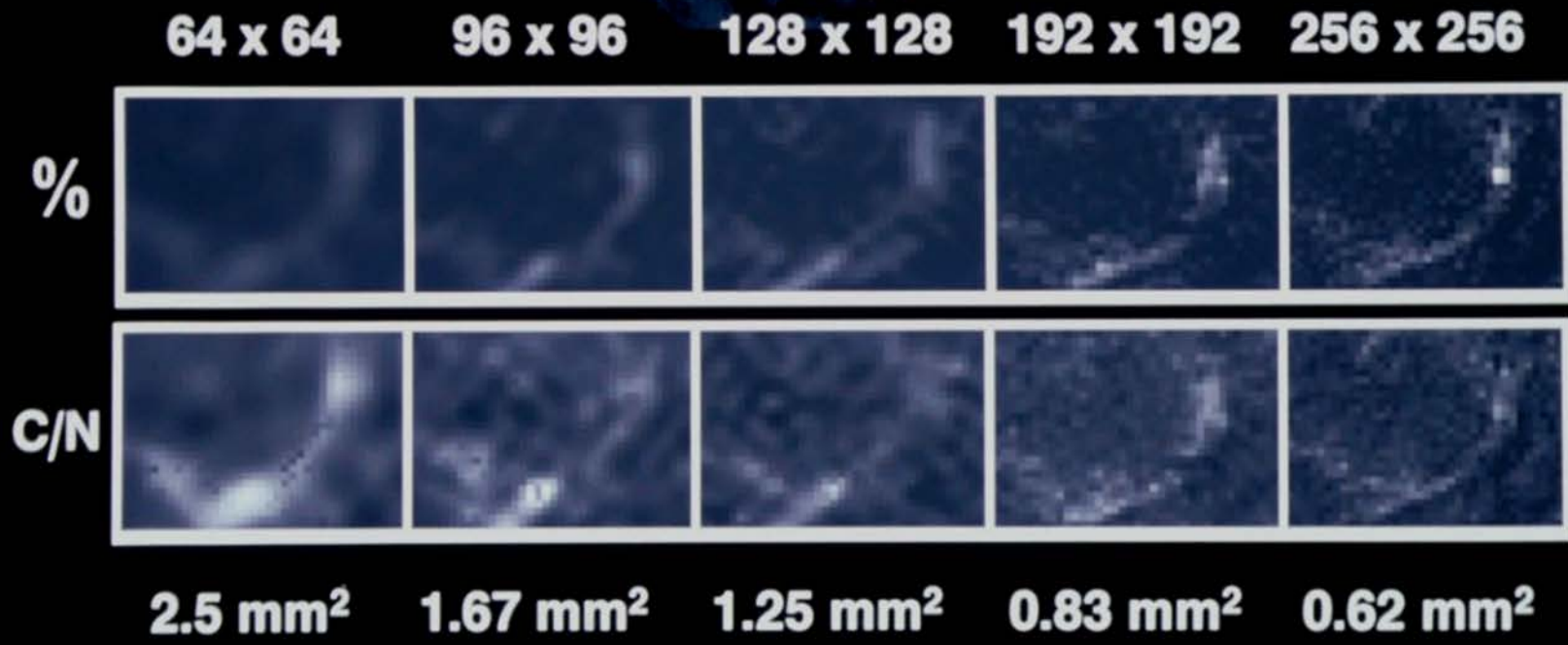

Fractional Signal Change

2.5 mm²

1.25 mm²

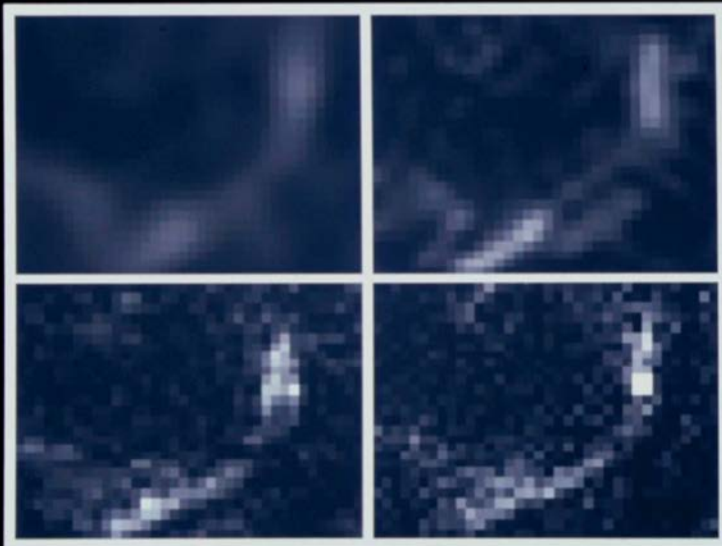

0.83 mm²

0.62 mm²

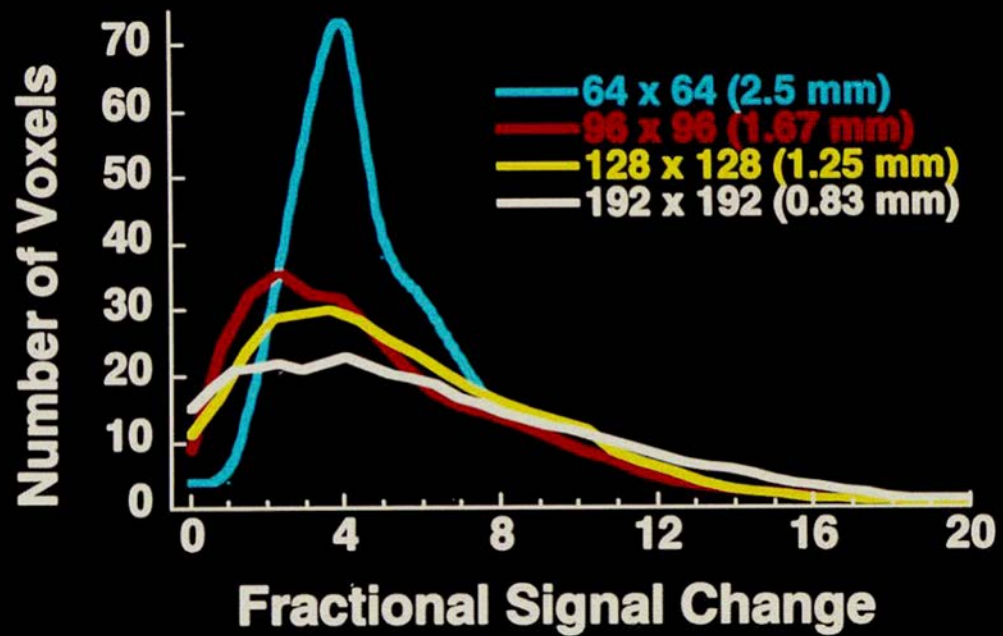

$$\Delta R2^* / \Delta R2$$

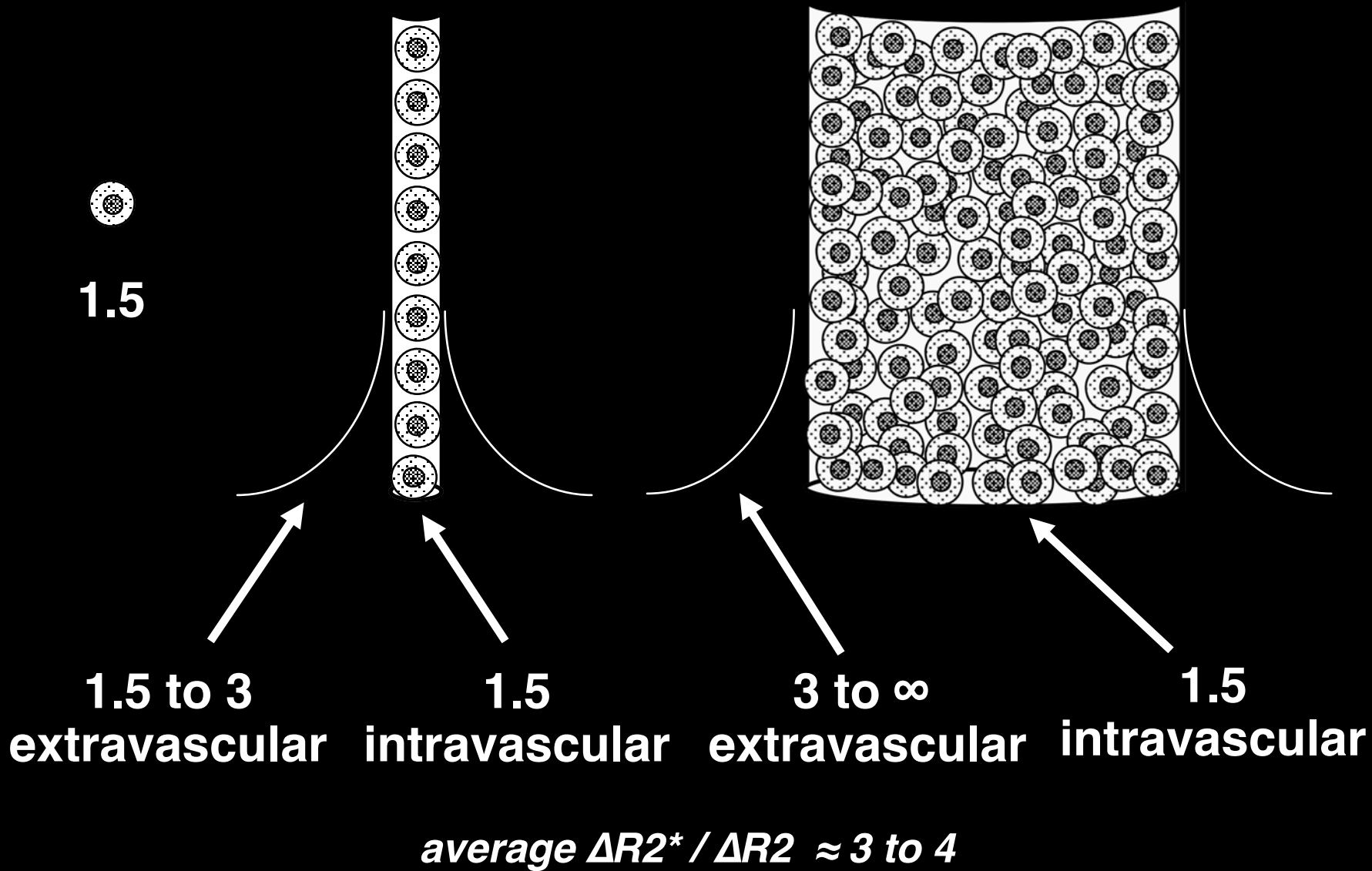

3T

Spin-Echo
TE = 105 ms
TR = ∞

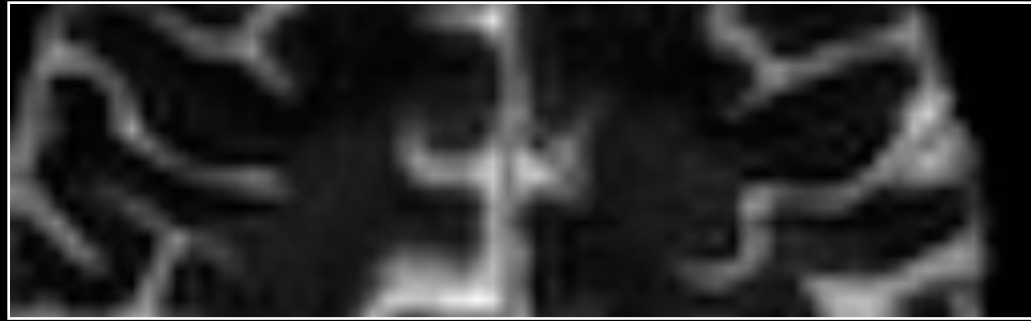

Gradient-Echo
TE = 50 ms



Gradient-Echo
functional
TE = 50 ms

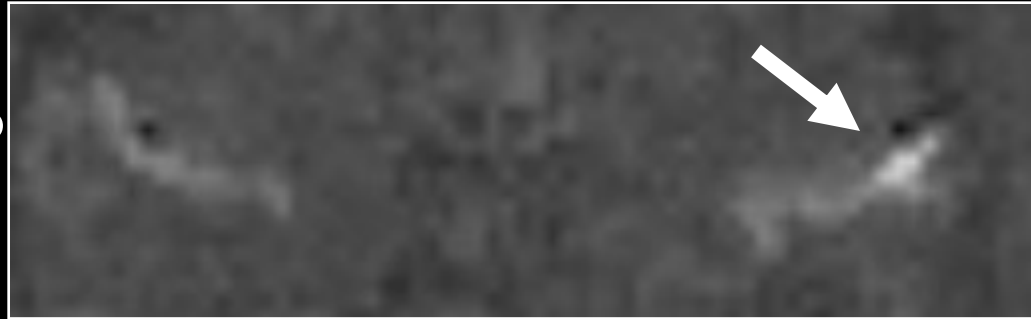

Spin-Echo
functional
TE = 105 ms



$b = 0$

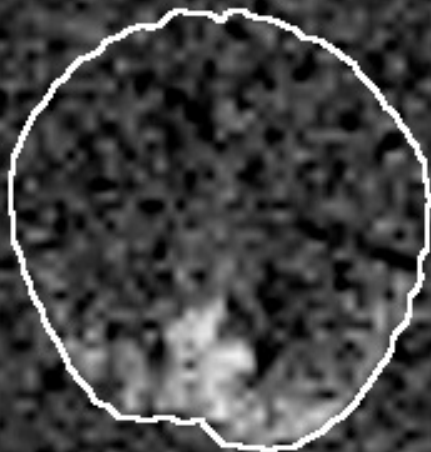

$b = 10$



$b = 50$

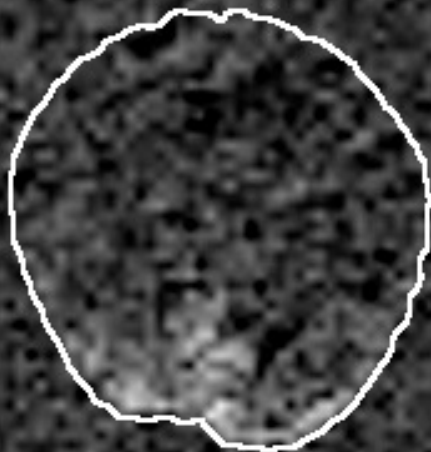

$b = 160$



Summary of Diffusion-Weighted fMRI Data

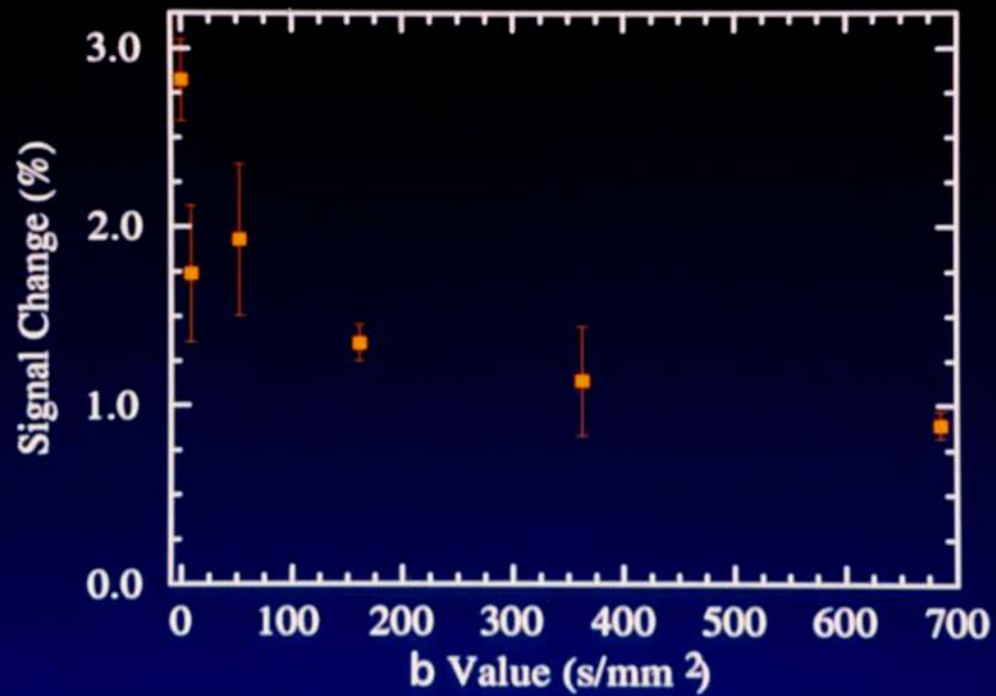

Anatomy



BOLD



Perfusion



Simultaneous Flow and BOLD

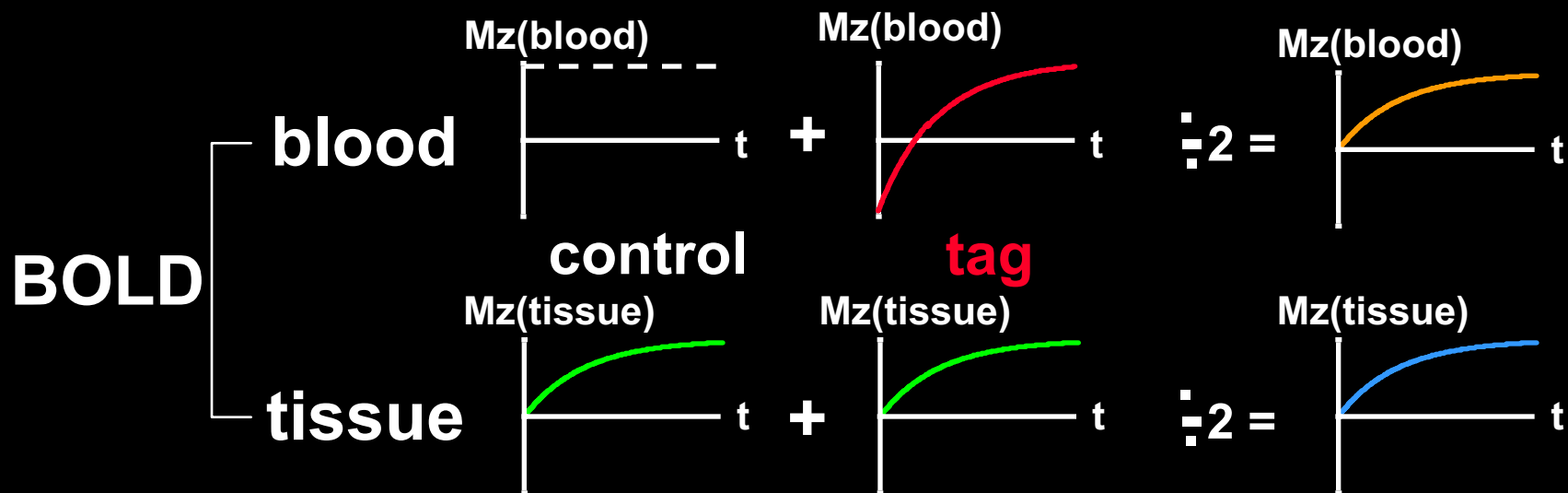
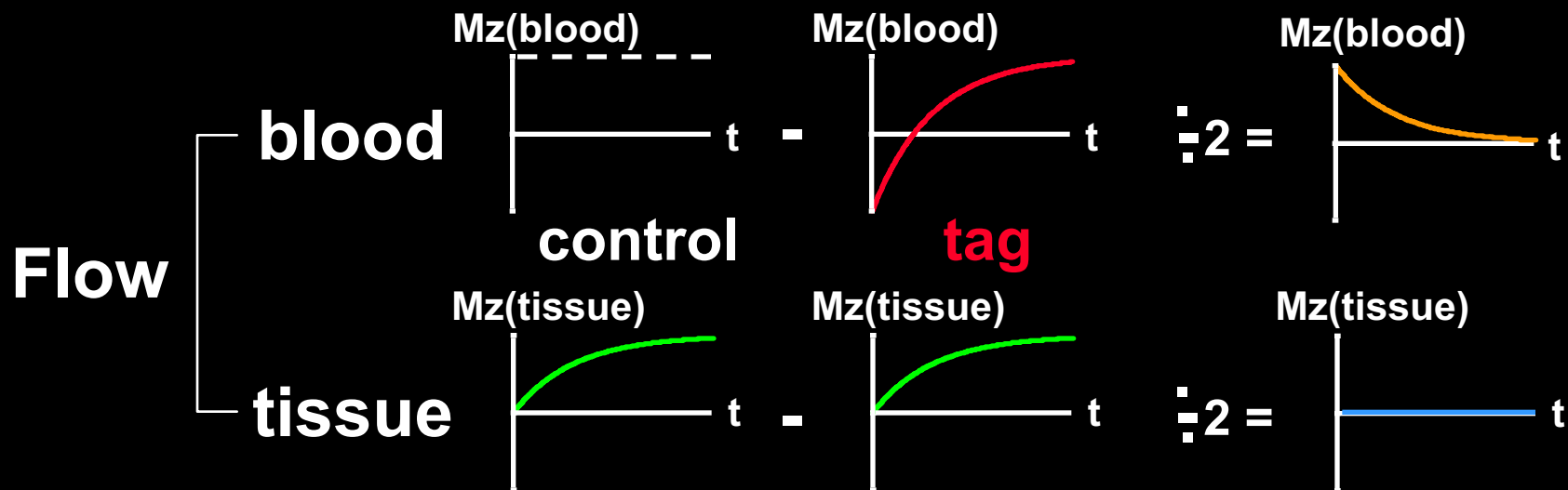

Simultaneous BOLD and Perfusion

perfusion

BOLD

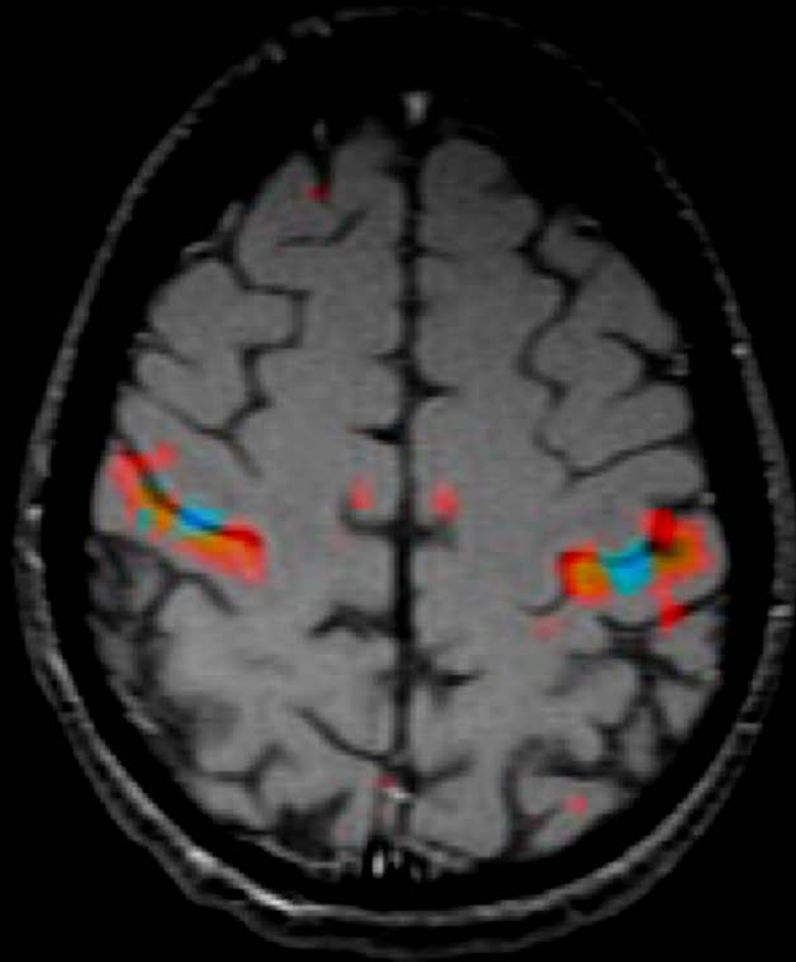

Angiogram
Perfusion
BOLD

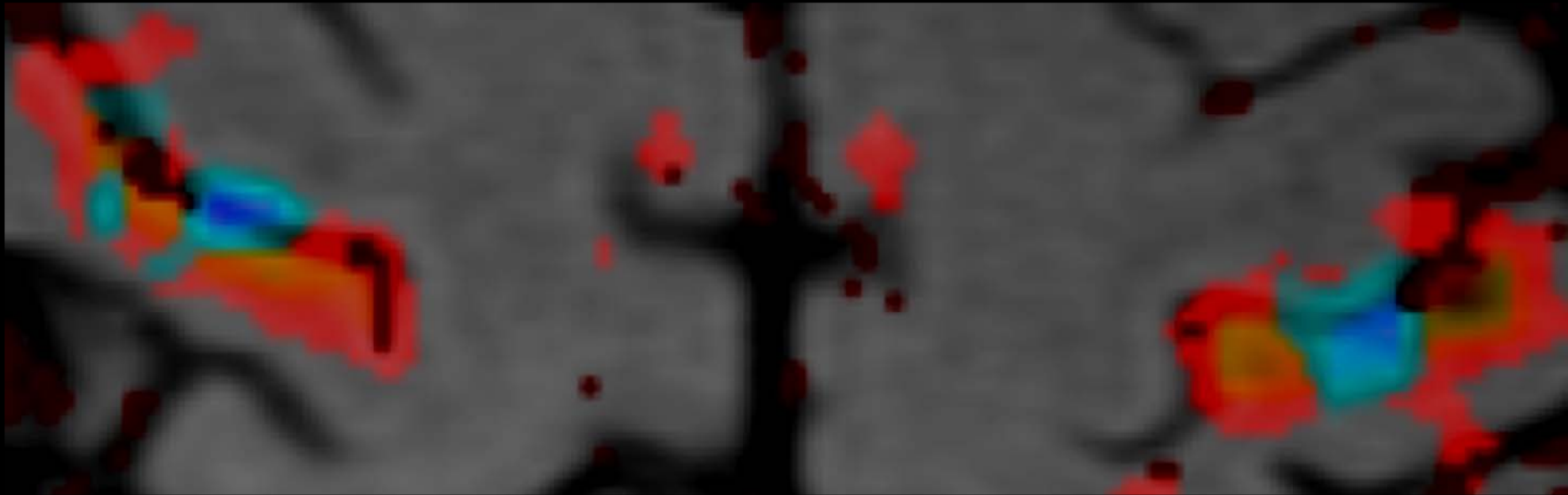

T1 - weighted



T2* weighted



**T1 and T2*
weighted**



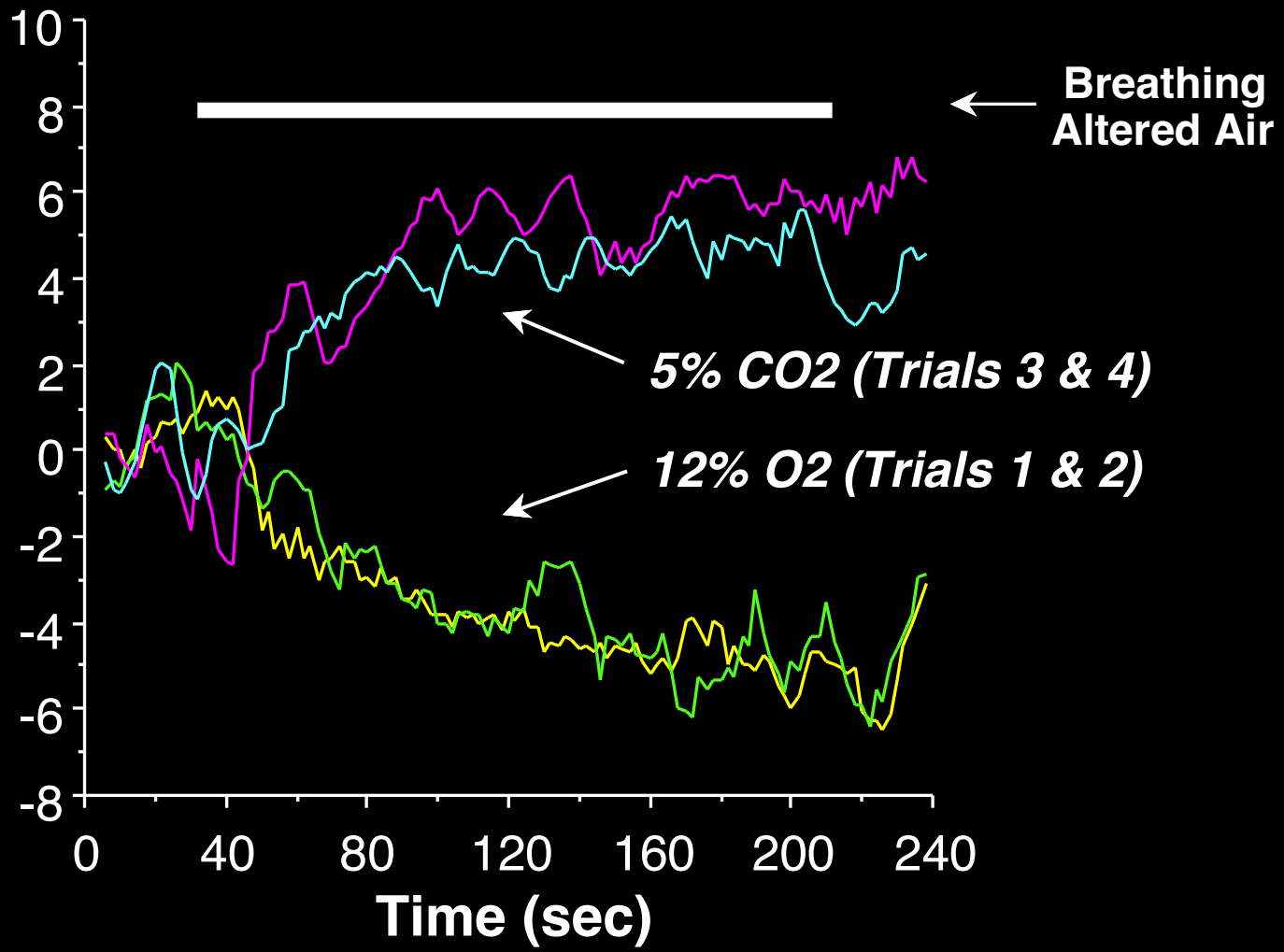

,

Anatomical

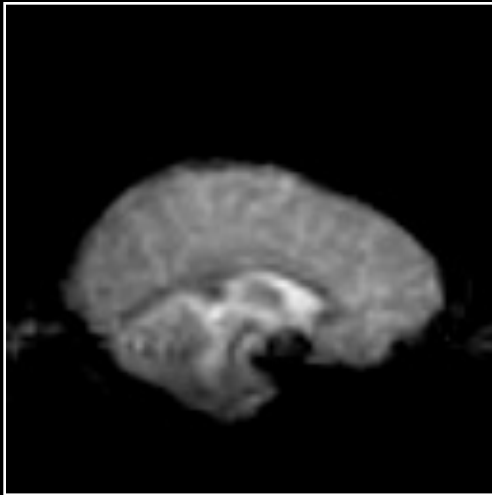

**Finger
Movement**



12% O2

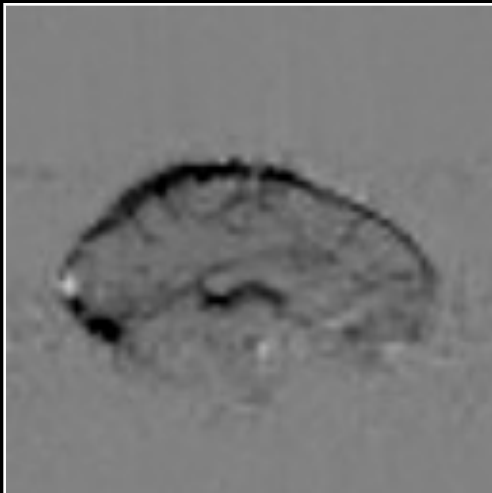

5% CO2

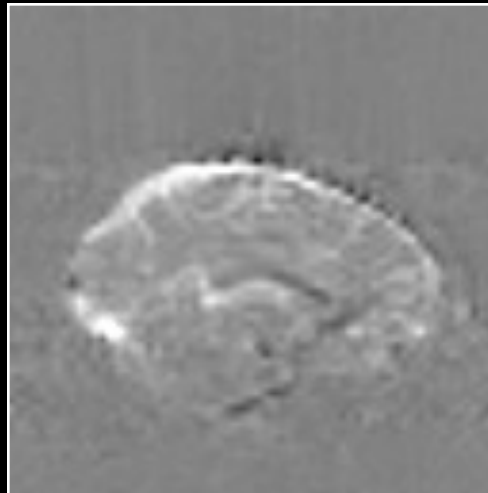

Resting State Blood Volume Weighting

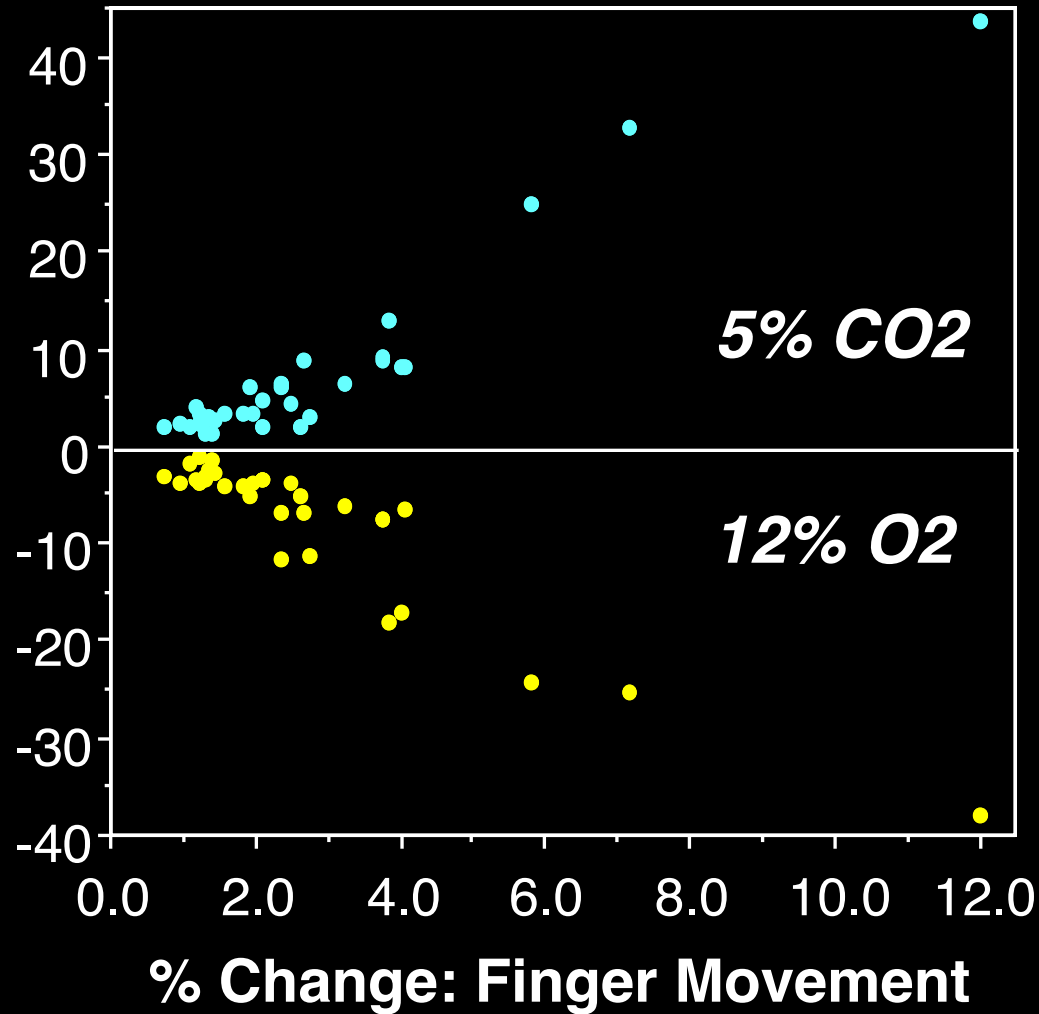

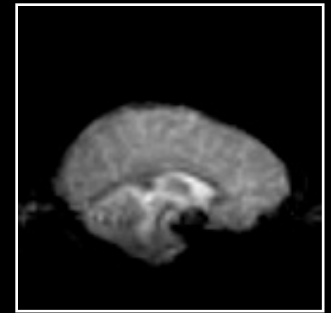

· · · · · Capillaries
——— Veins



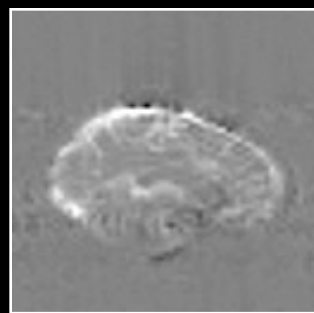

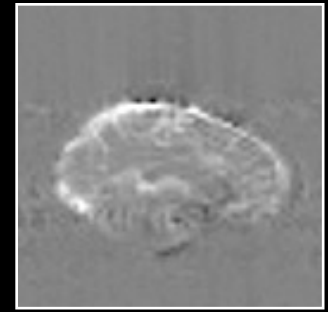

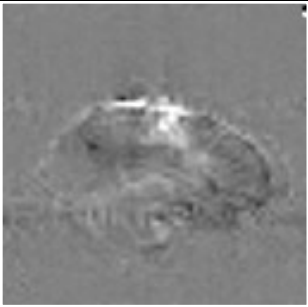

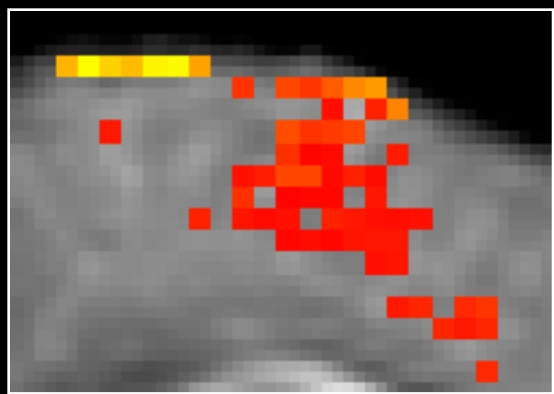

?

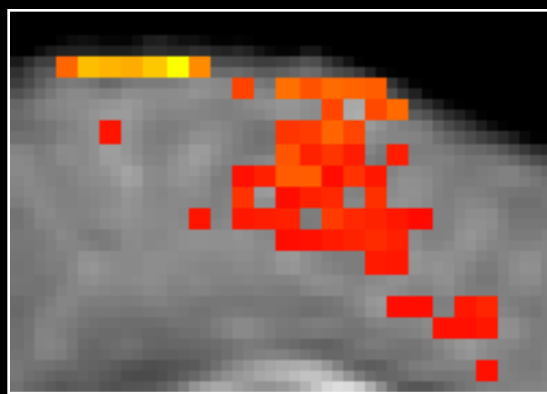

?

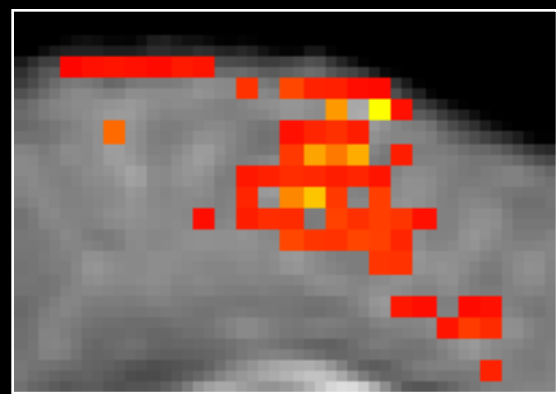

Latency

Magnitude

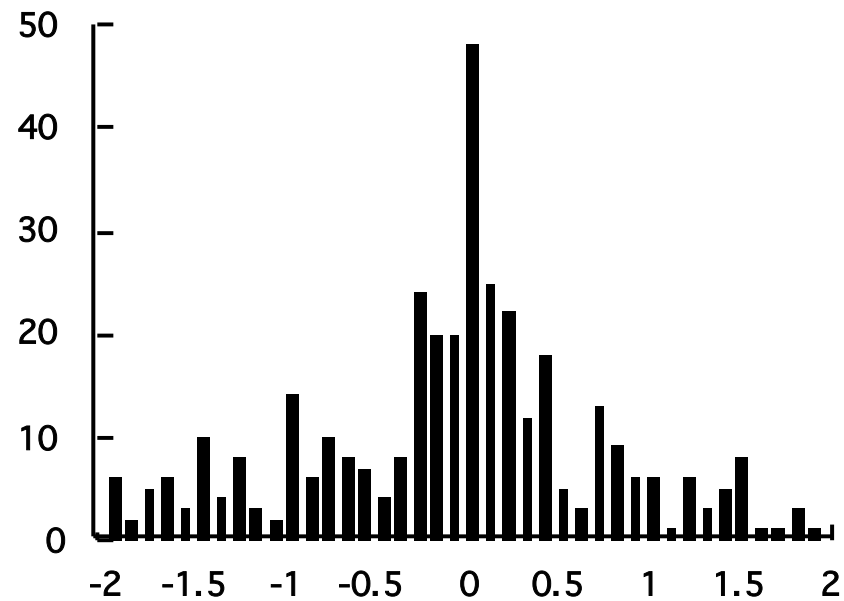
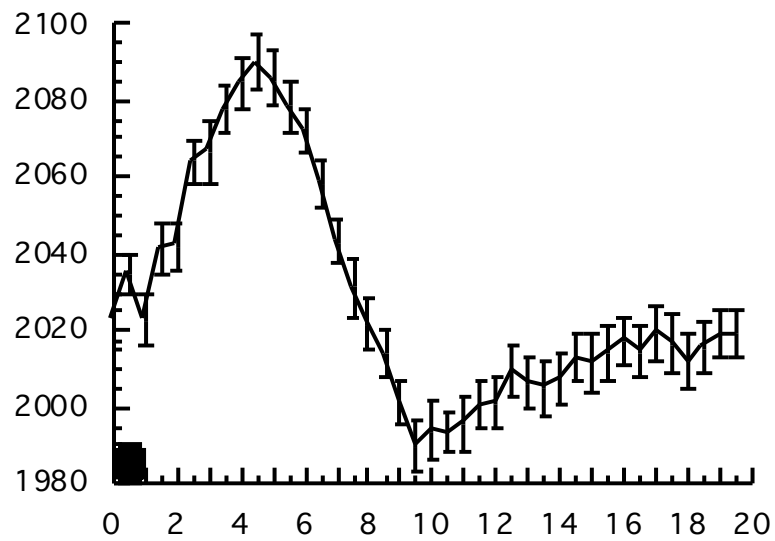
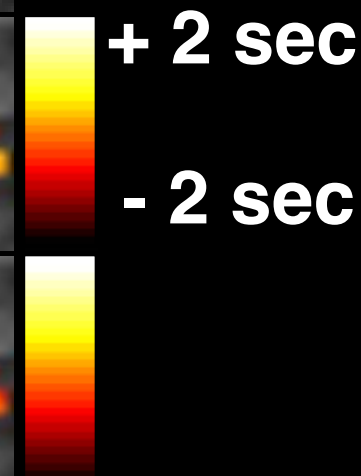
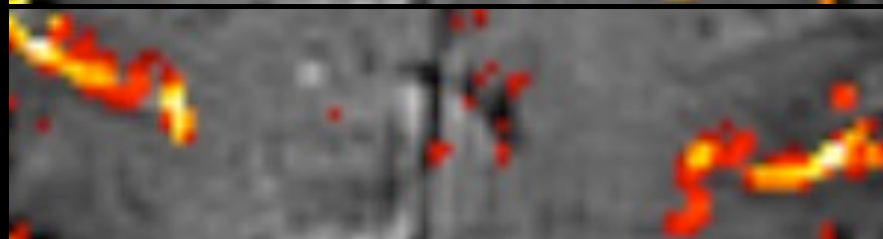
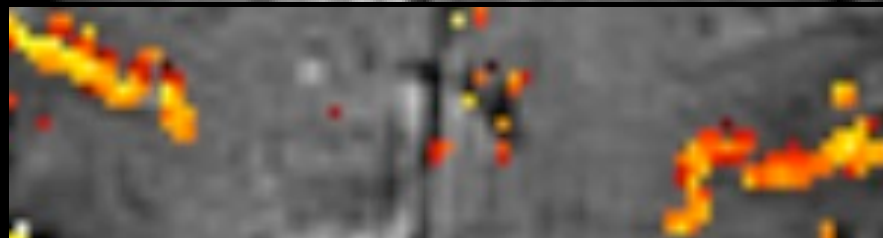

Time (sec)

Delay (sec)

1991-1992



1992-1999



????????????????????

Neuronal Activity



Hemodynamics



Measured fMRI signal

- Δ Blood Flow (CBF)
- Δ Blood Volume (CBV)
- Δ Oxygen Consumption (CMRO₂)

????????????????

Blood Oxygenation Level Dependent (BOLD) signal changes

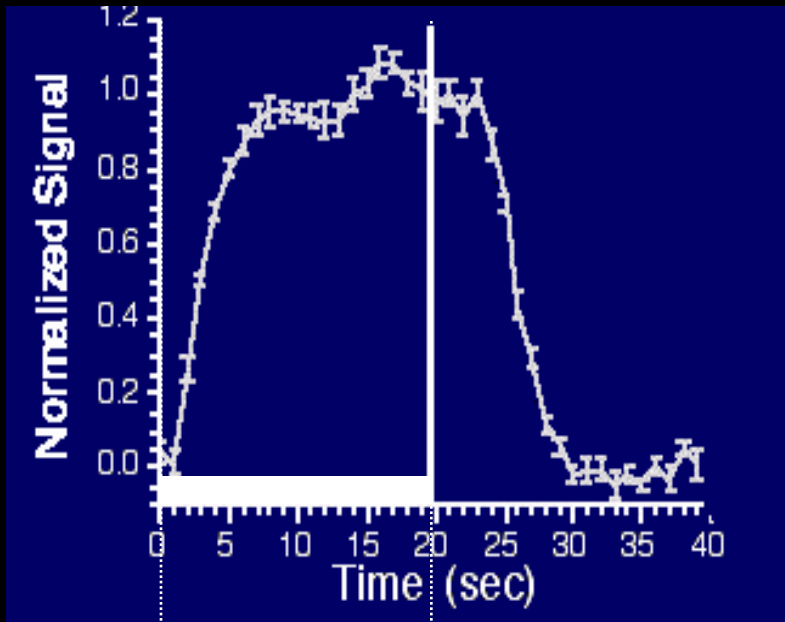

task

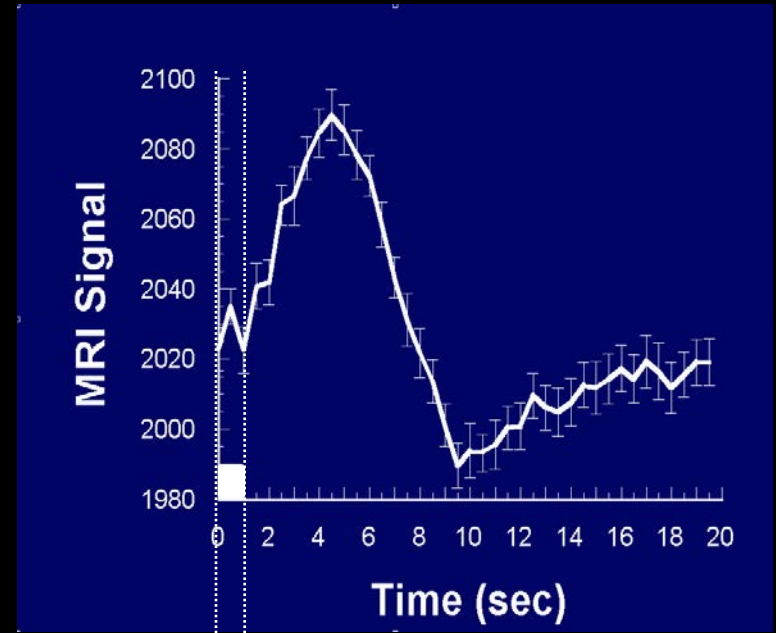

task

??????

Stimulus Duration (SD)



16 s



20 s

??????

?????

SD = 250 ms

SD = 500 ms

SD = 500 ms

SD = 1000 ms

SD = 1000 ms

SD = 2000 ms

SD = 2000 ms

SD = 4000 ms

Blocked Trial

??

Observed response

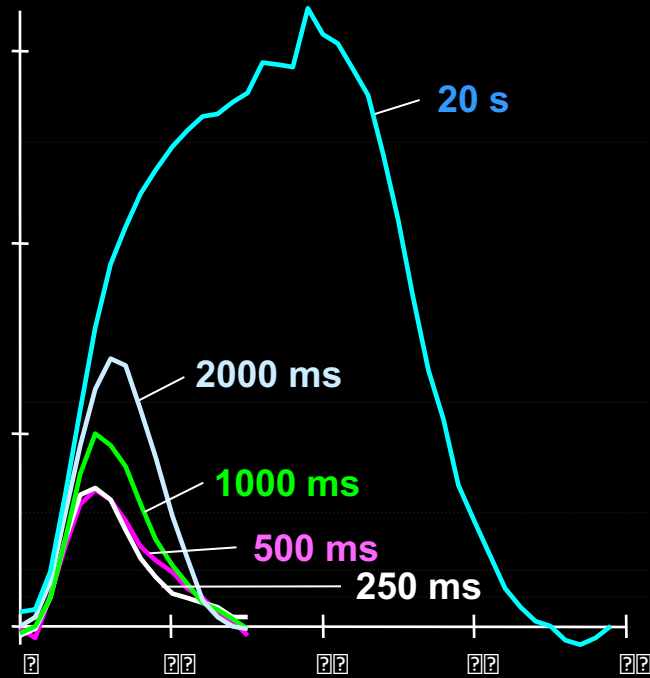

Linear response

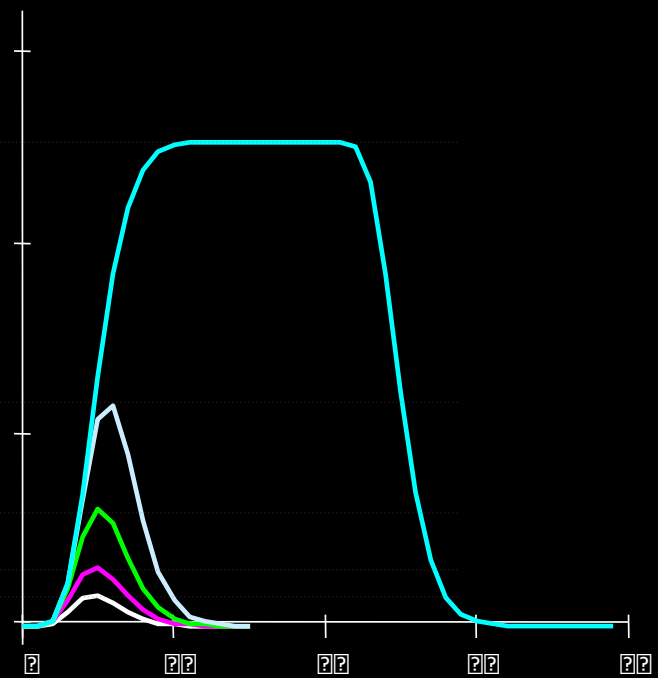

Short duration stimuli produce larger responses than expected

??????

Tasks

Visual Stimulation



Finger tapping

????????

??

Imaging Parameters

3 Tesla

EPI

64x64

24 cm FOV

5 mm slice thickness

8 slices

TR: 1000 ms

TE: 30 ms

320 time points

????????????????

Measured

Simulated (linear)

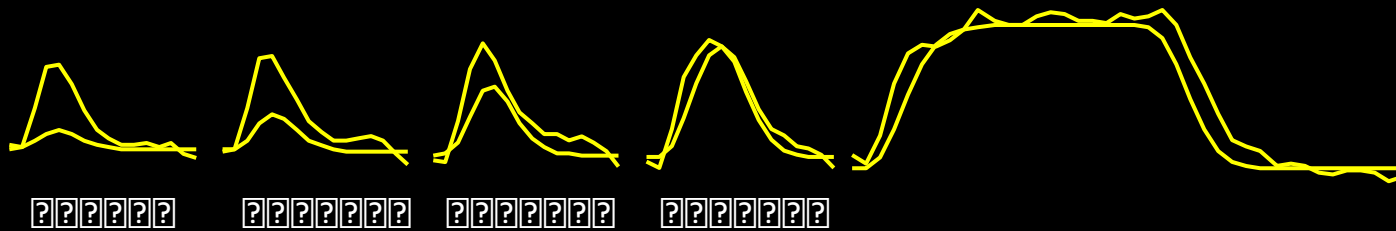
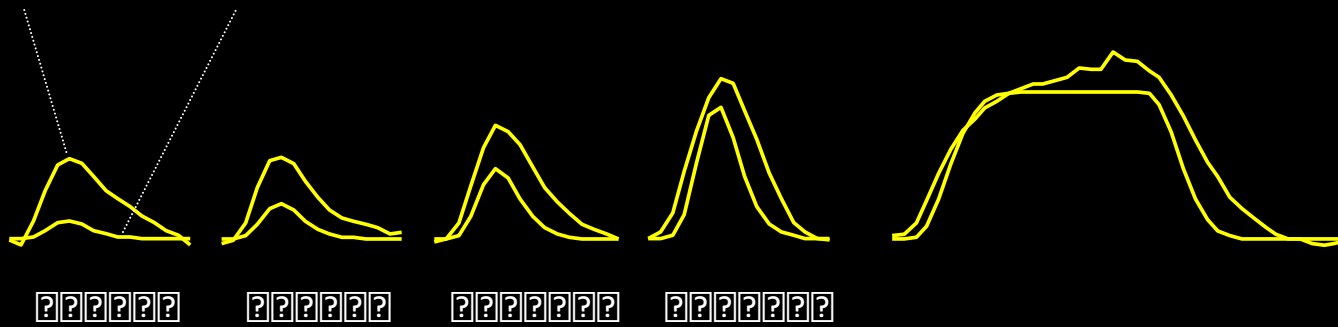

??

????????????????

- Amplitude of Response

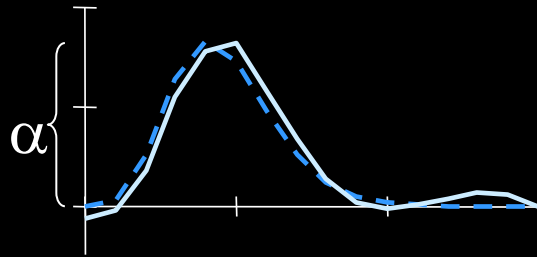

Fit ideal (linear) to response

- Area under response / Stimulus Duration

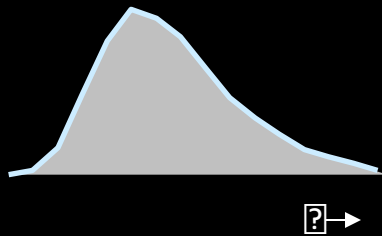

Output Area / Input Area

????????????

Visual



Motor



Magnitude

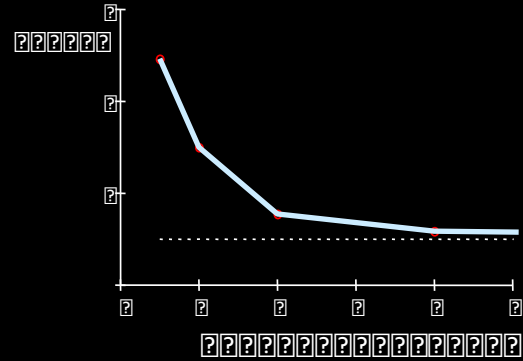
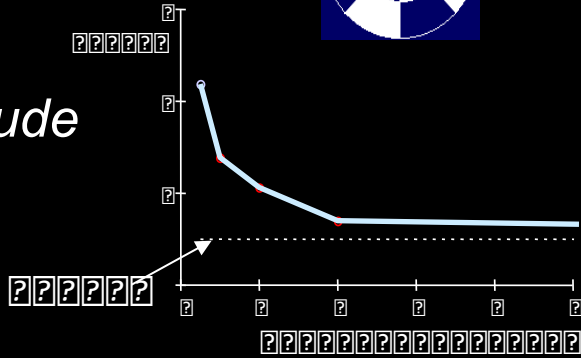

Area

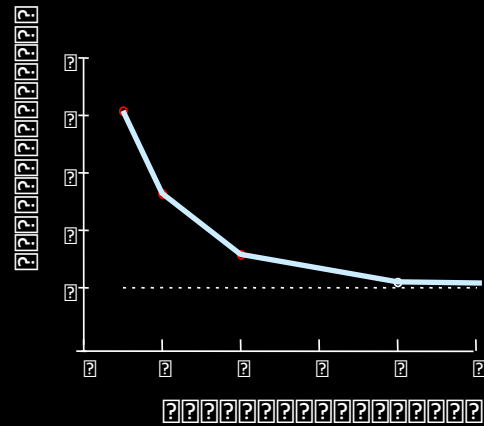
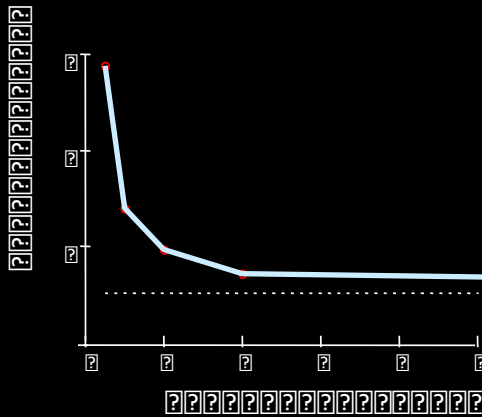

????????????????????????????????

- Area under nonlinearity curve

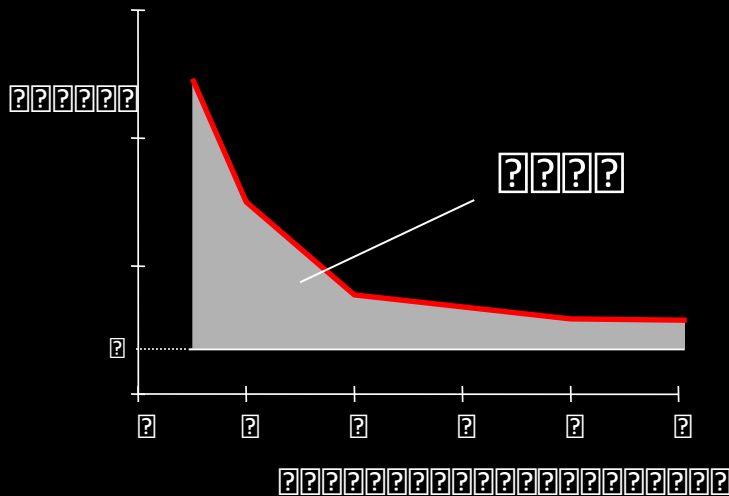

- Slope of nonlinearity curve

????????????????????????????????

?? ?

Nonlinearity

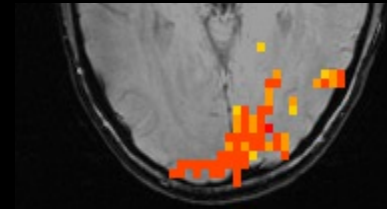
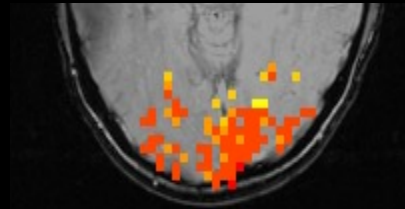
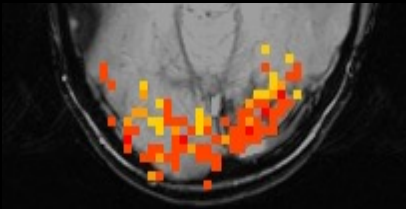

Magnitude

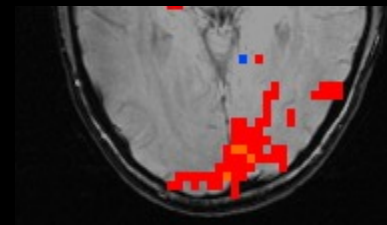
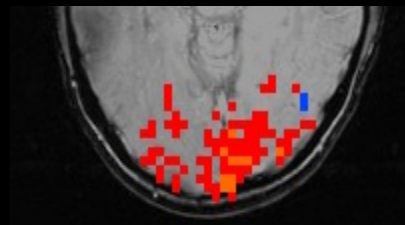
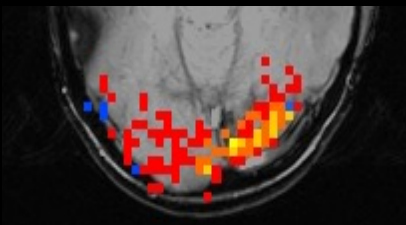

Latency

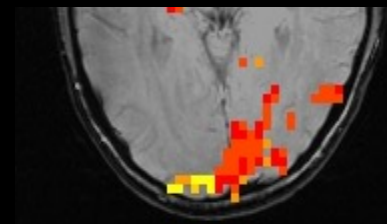
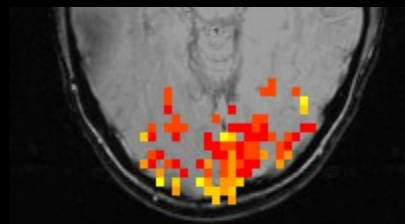
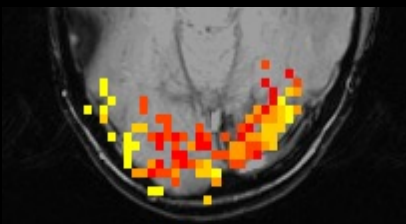

????????????????????????????????

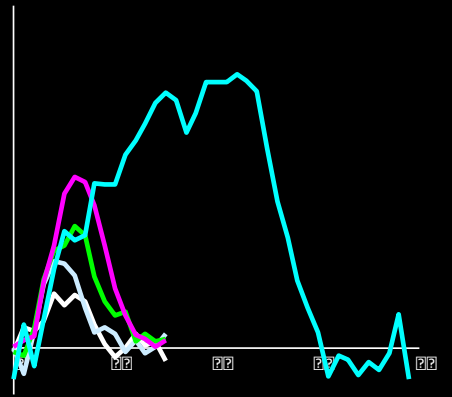
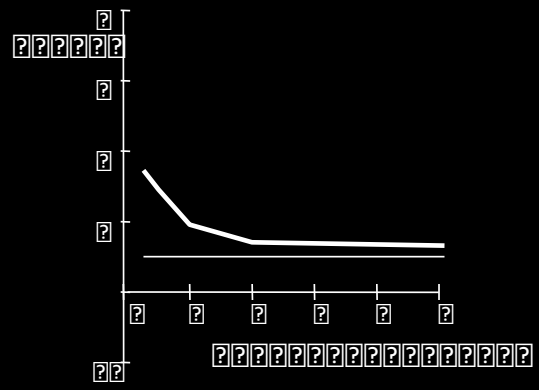
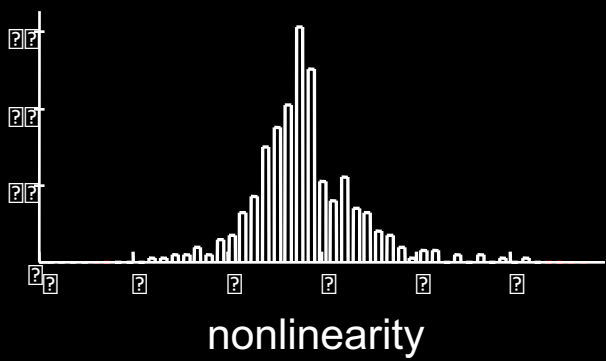
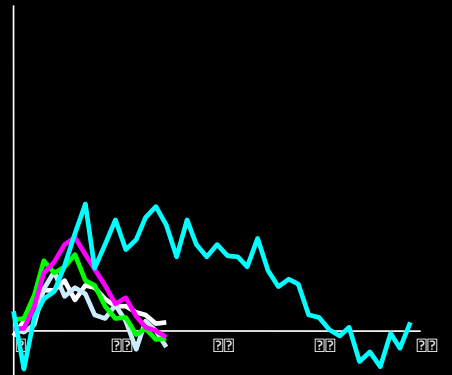
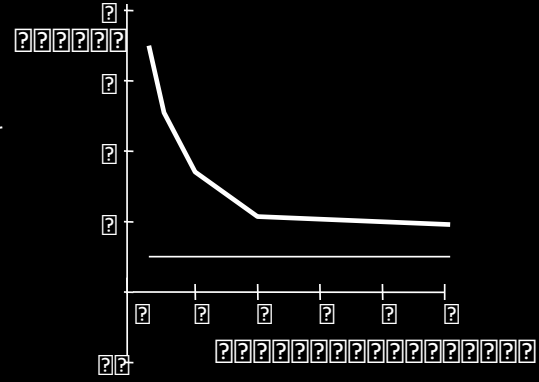
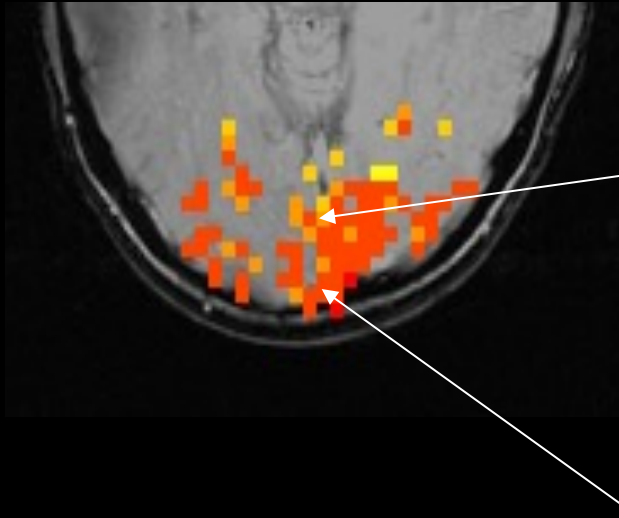

????????????????????

Nonlinearity

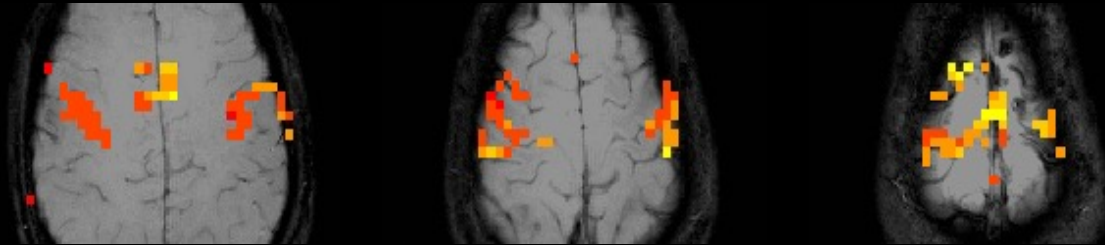

Magnitude

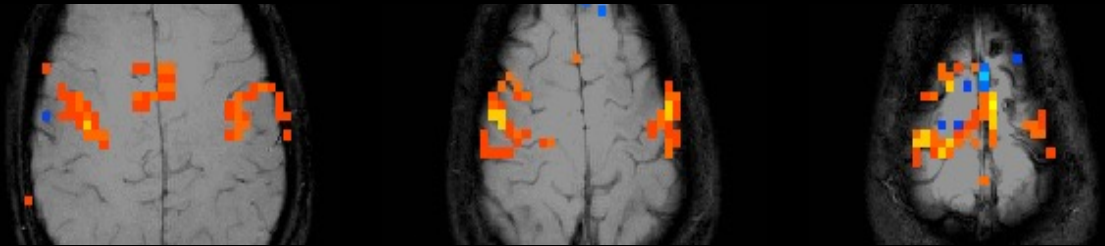

Latency

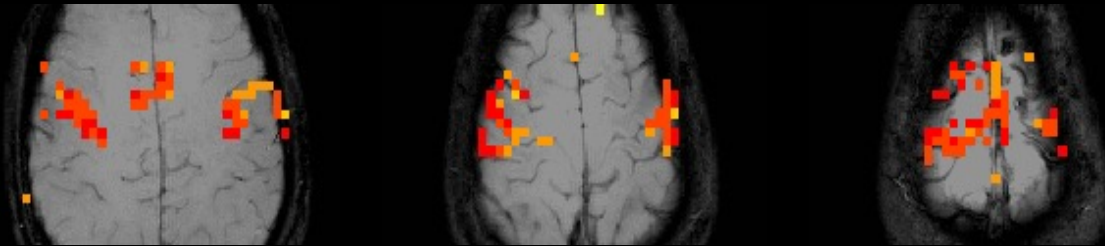

????????????????????

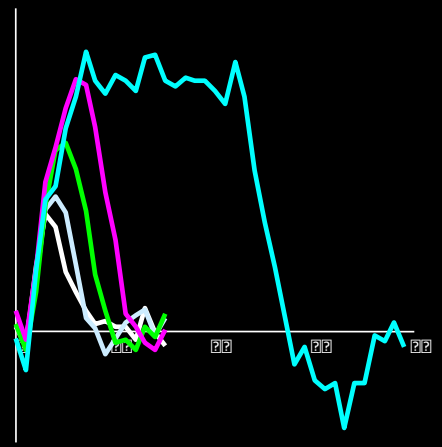
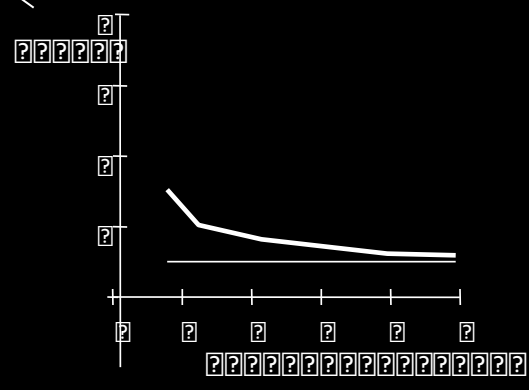
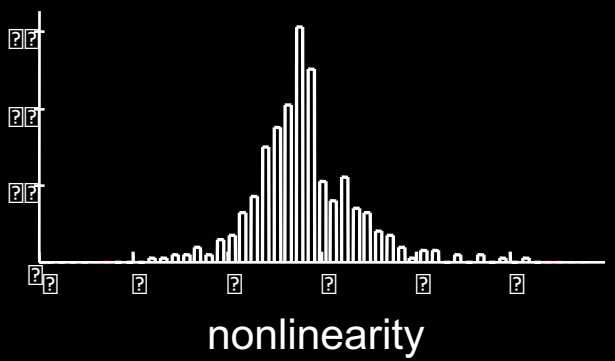
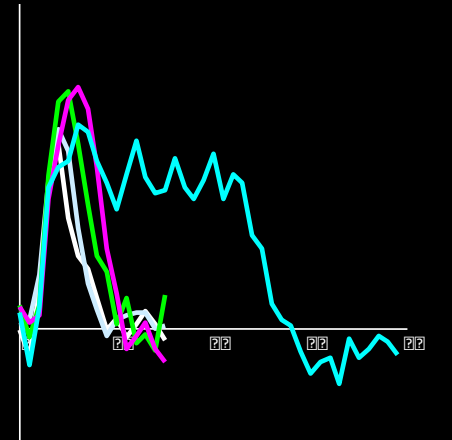
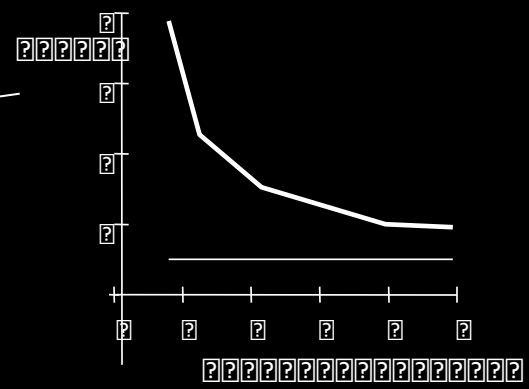
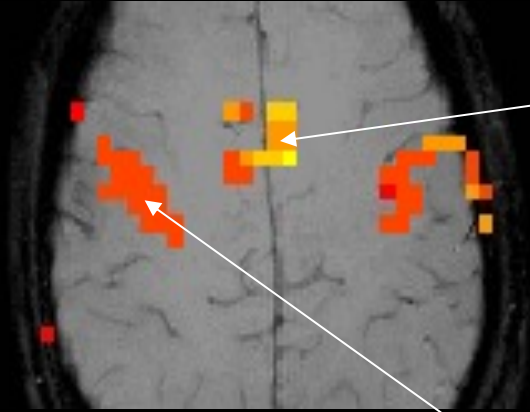

?? ? ? ? ? ? ? ? ? ? ? ? ? ? ?

Visual task

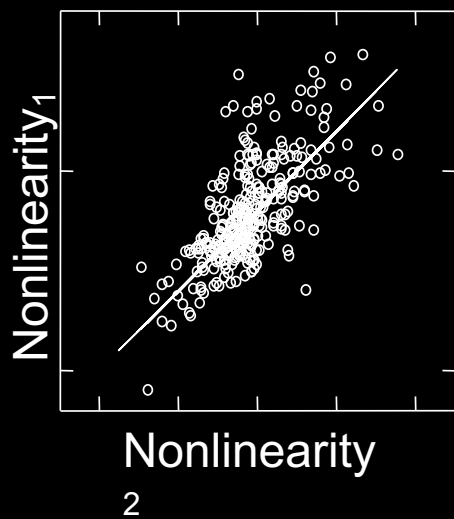

Motor task

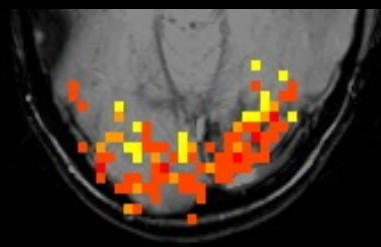
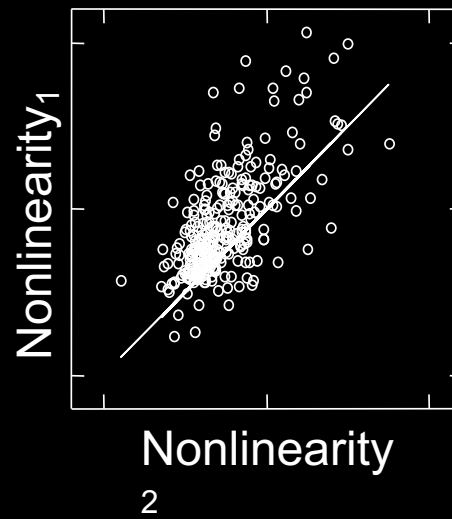

Experiment 1

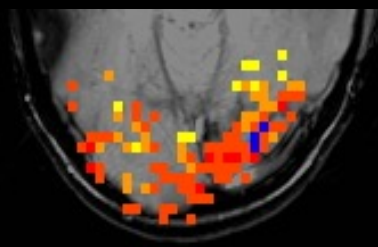

Experiment 2

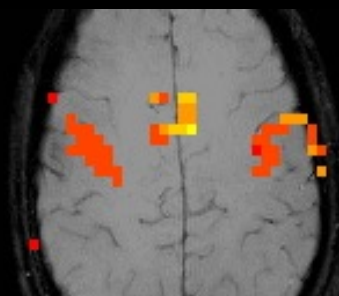

Experiment 1

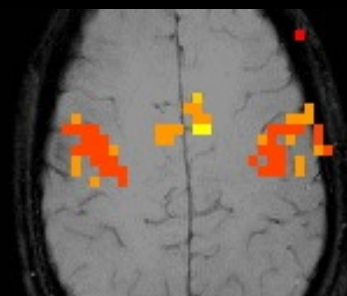

Experiment 2

Conclusions

- Responses to short duration stimuli are larger than predicted from a linear system
- Spatial variation in this nonlinear relationship is seen
- The variation in nonlinearity is not significantly correlated with magnitude or latency

Implications

- Nonlinearity is primarily neuronal in origin

or

- Magnitude and latency do not accurately reflect underlying vasculature